



Panasonic®

Operating Instructions

Link-to-Cell Docking Station for iPhone®

Model No. **KX-PRL262**

Link-to-Cell Docking Station for Smartphone

Model No. **KX-PRD262**

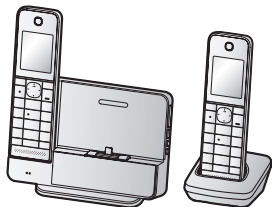

Model shown is KX-PRL262.

***Before initial use, see “Getting Started”
on page 10.***

Thank you for purchasing a Panasonic product.

Please read these operating instructions before using the unit and save them for future reference.

Consulte “Guía Rápida Española”, página 72.

For assistance, visit our Web site: <http://www.panasonic.com/help> for customers in the U.S.A. or Puerto Rico.

Please register your product: <http://www.panasonic.com/prodreg>

Table of Contents

Introduction

Model composition	3
Accessory information	3

Important Information

For your safety	6
Important safety instructions	7
For best performance	7
Other information	8
Specifications	9

Getting Started

Setting up	10
Controls	12
Charging your smartphone	13
Display icons/Indicators	14
Language settings	15
Date and time	15
Recording your greeting message	15
Other settings	16

Link to Cell

Link to cell feature	17
Pairing a cellular phone	17
Link to cell settings	18

Making/Answering Calls

Making cellular calls	21
Making landline calls	21
Answering calls	22
Useful features during a call	22
Intercom	26

Phonebook

Phonebook	27
Speed dial	30

Programming

Menu list	32
Alarm	39
Silent mode	40
Call block	40
Other programming	42
Registering a unit	42

Caller ID Service

Using Caller ID service	44
Caller list	44

Using Bluetooth Devices

Copying phonebook from a cellular phone (phonebook transfer)	47
Playing music from a Bluetooth device	48
Text message (SMS) alert	49

Answering System for Landline

Answering system for landline	51
Turning the answering system on/off	51
Greeting message	51
Listening to messages	52
Advanced new message alerting features	53
Remote operation	54
Answering system settings	56

Useful Information

Voice mail service for landline	58
Error messages	60
Troubleshooting	61
FCC and other information	69

Guía Rápida Española

Guía Rápida Española	72
----------------------------	----

Appendix

Customer services	82
Warranty (For United States and Puerto Rico)	83

Index

Index	85
-------------	----

Model composition

Series	Model No.	Base unit	Handset	
		Part No.	Part No.	Quantity
KX-PRL260 series	KX-PRL262	KX-PRL260	KX-PRLA20	2
KX-PRD260 series	KX-PRD262	KX-PRD260	KX-PRLA20	2

Accessory information

Supplied accessories

No.	Accessory item/Order number	Quantity
①	AC adaptor for base unit/PNLV238-KZ	1
②	Telephone line cord/PQJA10075Z	1
③	Rechargeable batteries/HHR-4DPA	4
④	Handset cover*1/PNYNTGHA20BR	2
⑤	Charger/PNLC1054ZB	1
⑥	AC adaptor for charger/PNLV233Z	1

*1 The handset cover comes attached to the handset.



Additional/replacement accessories

Please contact your nearest Panasonic dealer for sales information (page 82).

Accessory item	Order number
Rechargeable batteries	HHR-4DPA*1
	<ul style="list-style-type: none"> ● To order, please visit http://www.panasonic.com/batterystore Battery type: <ul style="list-style-type: none"> – Nickel metal hydride (Ni-MH) – 2 x AAA (R03) size for each handset
T-adaptor	KX-J66
Range extender	KX-TGA405*2

Introduction

Accessory item	Order number
Key detector	KX-TGA20*3

- *1 Replacement batteries may have a different capacity from that of the supplied batteries.
- *2 By installing this unit, you can extend the range of your phone system to include areas where reception was previously not available. This product can be purchased online. Please visit our Web site: <http://www.panasonic.com/RangeExtender>
- *3 By registering the key detector (4 max.) to a Panasonic Digital Cordless Phone and attaching it to an easy-to-lose item in advance, you can locate and find the mislaid item to which the key detector is attached. Please visit our Web site: <http://panasonic.net/pcc/products/telephone/p/tga20/>

Other information

- Design and specifications are subject to change without notice.
- The illustrations in these instructions may vary slightly from the actual product.

Expanding your phone system

Handset (optional): KX-PRLA20	
<p>You can expand your phone system by registering optional handsets (6 max.) to a single base unit.</p> <ul style="list-style-type: none">● Optional handsets may be a different color from that of the supplied handsets.	

Bluetooth® devices

You can expand your phone system by pairing the following units to a single base unit.

Your Bluetooth cellular phone*1: 2 max. (for cellular calls: page 17)	
--	--

- *1 Your cellular phone must be Bluetooth wireless technology compatible. To use the music player feature, your Bluetooth device must support music playback. For more details and a list of compatible devices, please visit the following web site: <http://www.panasonic.com/link2cell>

Trademarks

- The Bluetooth® word mark and logos are registered trademarks owned by Bluetooth SIG, Inc., and any use of such marks by Panasonic Corporation is under license.
- iPhone is a registered trademark of Apple Inc.

- Lightning is a trademark of Apple Inc.
- Android is a trademark of Google Inc.
- All other trademarks identified herein are the property of their respective owners.

For your safety

To prevent severe injury and loss of life/property, read this section carefully before using the product to ensure proper and safe operation of your product.

WARNING

Power connection

- Use only the power source marked on the product.
- Do not overload power outlets and extension cords. This can result in the risk of fire or electric shock.
- Completely insert the AC adaptor/power plug into the power outlet. Failure to do so may cause electric shock and/or excessive heat resulting in a fire.
- Regularly remove any dust, etc. from the AC adaptor/power plug by pulling it from the power outlet, then wiping with a dry cloth. Accumulated dust may cause an insulation defect from moisture, etc. resulting in a fire.
- Unplug the product from power outlets if it emits smoke, an abnormal smell, or makes an unusual noise. These conditions can cause fire or electric shock. Confirm that smoke has stopped emitting and contact us at <http://www.panasonic.com/contactinfo>
- Unplug from power outlets and never touch the inside of the product if its casing has been broken open.
- Never touch the plug with wet hands. Danger of electric shock exists.

Installation

- To prevent the risk of fire or electrical shock, do not expose the product to rain or any type of moisture.
- Do not place or use this product near automatically controlled devices such as automatic doors and fire alarms. Radio waves emitted from this product may cause such devices to malfunction resulting in an accident.

- Do not allow the AC adaptor or telephone line cord to be excessively pulled, bent or placed under heavy objects.

Operating safeguards

- Unplug the product from power outlets before cleaning. Do not use liquid or aerosol cleaners.
- Do not disassemble the product.
- Do not spill liquids (detergents, cleansers, etc.) onto the telephone line cord plug, or allow it to become wet at all. This may cause a fire. If the telephone line cord plug becomes wet, immediately pull it from the telephone wall jack, and do not use.

Medical

- Consult the manufacturer of any personal medical devices, such as pacemakers or hearing aids, to determine if they are adequately shielded from external RF (radio frequency) energy. (The product operates in the frequency range of 1.92 GHz to 1.93 GHz, and the RF transmission power is 115 mW (max..))
- Do not use the product in health care facilities if any regulations posted in the area instruct you not to do so. Hospitals or health care facilities may be using equipment that could be sensitive to external RF energy.

CAUTION

Installation and location

- Never install telephone wiring during an electrical storm.
- Never install telephone line jacks in wet locations unless the jack is specifically designed for wet locations.
- Never touch insulated telephone wires or terminals unless the telephone line has been disconnected at the network interface.
- Use caution when installing or modifying telephone lines.
- The AC adaptor is used as the main disconnect device. Ensure that the AC outlet is installed near the product and is easily accessible.

- This product is unable to make calls when:
 - the handset batteries need recharging or have failed.
 - there is a power failure.

Battery

- We recommend using the batteries noted on page 3. **USE ONLY rechargeable Ni-MH batteries AAA (R03) size.**
- Do not mix old and new batteries.
- Do not open or mutilate the batteries. Released electrolyte from the batteries is corrosive and may cause burns or injury to the eyes or skin. The electrolyte is toxic and may be harmful if swallowed.
- Exercise care when handling the batteries. Do not allow conductive materials such as rings, bracelets, or keys to touch the batteries, otherwise a short circuit may cause the batteries and/or the conductive material to overheat and cause burns.
- Charge the batteries provided with or identified for use with this product only, in accordance with the instructions and limitations specified in this manual.
- Only use a compatible base unit (or charger) to charge the batteries. Do not tamper with the base unit (or charger). Failure to follow these instructions may cause the batteries to swell or explode.

Attention:



A nickel metal hydride battery that is recyclable powers the product you have purchased.

Please call 1-800-8-BATTERY (1-800-822-8837) for information on how to recycle this battery.

Important safety instructions

When using your product, basic safety precautions should always be followed to reduce the risk of fire, electric shock, and injury to persons, including the following:

1. Do not use this product near water for example, near a bathtub, washbowl, kitchen sink, or laundry tub, in a wet basement or near a swimming pool.
2. Avoid using a telephone (other than a cordless type) during an electrical storm. There may be a remote risk of electric shock from lightning.
3. Do not use the telephone to report a gas leak in the vicinity of the leak.
4. Use only the power cord and batteries indicated in this manual. Do not dispose of batteries in a fire. They may explode. Check with local codes for possible special disposal instructions.

SAVE THESE INSTRUCTIONS

For best performance

Base unit location/avoiding noise

The base unit and other compatible Panasonic units use radio waves to communicate with each other.

- For maximum coverage and noise-free communications, place your base unit:
 - at a convenient, high, and central location with no obstructions between the handset and base unit in an indoor environment.
 - away from electronic appliances such as TVs, radios, personal computers, wireless devices, or other phones.
 - facing away from radio frequency transmitters, such as external antennas of mobile phone cell stations. (Avoid putting the base unit on a bay window or near a window.)
- Coverage and voice quality depends on the local environmental conditions.

Important Information

- If the reception for a base unit location is not satisfactory, move the base unit to another location for better reception.

Environment

- Keep the product away from electrical noise generating devices, such as fluorescent lamps and motors.
- The product should be kept free from excessive smoke, dust, high temperature, and vibration.
- The product should not be exposed to direct sunlight.
- Do not place heavy objects on top of the product.
- When you leave the product unused for a long period of time, unplug the product from the power outlet.
- The product should be kept away from heat sources such as heaters, kitchen stoves, etc. It should not be placed in rooms where the temperature is less than 0 °C (32 °F) or greater than 40 °C (104 °F). Damp basements should also be avoided.
- The maximum calling distance may be shortened when the product is used in the following places: Near obstacles such as hills, tunnels, underground, near metal objects such as wire fences, etc.
- Operating the product near electrical appliances may cause interference. Move away from the electrical appliances.

Routine care

- **Wipe the outer surface of the product with a soft moist cloth.**
- Do not use benzine, thinner, or any abrasive powder.

Other information

CAUTION: Risk of explosion if battery is replaced by an incorrect type. Dispose of used batteries according to the instructions.

Notice for product disposal, transfer, or return

- This product can store your private/confidential information. To protect your privacy/confidentiality, we recommend that you erase information such as phonebook or caller list entries from the memory before you dispose of, transfer, or return the product.

Notice

- This product is designed for use in the United States of America. Sale or use of this product in other countries may violate local laws.
- Cet appareil est conçu pour être utilisé aux États-Unis d'Amérique. La vente ou l'emploi de cet appareil dans certains autres pays peut constituer une infraction à la législation locale.
- Este producto está diseñado para usarse en los Estados Unidos de América. La venta o el empleo de este producto en ciertos países puede constituir violación de la legislación local.
- 本產品專為美國使用而設。若在其他國家銷售或使用，可能會違反當地法例。
- この製品は、日本国外での使用を目的として設計されており、日本国内での使用は法律違反となります。従って、当社では日本国内においては原則として修理などのサービスは致しかねます。

Specifications

- **Standard:**
DECT 6.0 (Digital Enhanced Cordless
Telecommunications 6.0)
Bluetooth wireless technology 2.1+EDR
- **Frequency range:**
1.92 GHz to 1.93 GHz (DECT)
2.402 GHz to 2.48 GHz (Bluetooth)
- **RF transmission power:**
115 mW (max.)
- **Power source:**
120 V AC, 60 Hz
- **Power consumption:**
Base unit:
Standby: Approx. 1.1 W
Maximum: Approx. 13.5 W
Charger:
Standby: Approx. 0.1 W
Maximum: Approx. 1.8 W
- **Operating conditions:**
0 °C – 40 °C (32 °F – 104 °F), 20 % – 80 %
relative air humidity (dry)

Setting up

Connections

- If you do not connect the telephone line cord and use only cellular lines, set the cellular line only mode to use this unit more conveniently (page 19).

■ Base unit

- ① Run the telephone line cord (A) and AC adaptor (B) through the slot of the stand.
- ② Connect the telephone line cord (A) and AC adaptor (B) to the jacks at the bottom of the unit until you hear a click.
- ③ Connect the AC adaptor to the power outlet.
- ④ Connect the telephone line cord to the single-line telephone jack (RJ11C) until you hear a click.
- ⑤ A DSL/ADSL filter (not supplied) is required if you have DSL/ADSL service.

Note:

- Use only the supplied Panasonic AC adaptor PNLV238.

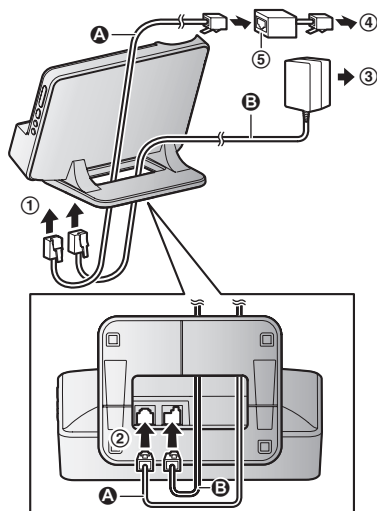

■ Charger

- ① Connect the AC adaptor plug to the charger until you hear a click.
- ② Connect the AC adaptor to the power outlet.

Note:

- Use only the supplied Panasonic AC adaptor PNLV233.

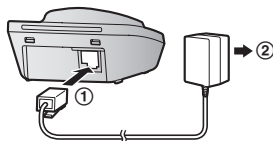

Battery installation

- USE ONLY rechargeable Ni-MH batteries AAA (R03) size (A).
- Do NOT use Alkaline/Manganese/Ni-Cd batteries.
- Confirm correct polarities (+, -).

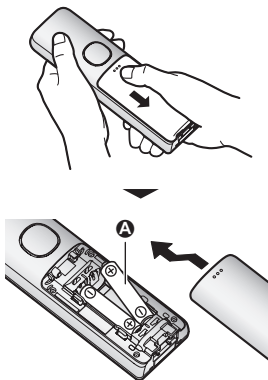

- Follow the directions on the display to set up the unit.

Battery charging

Charge for about 7 hours.

- Confirm "charging" is displayed (A).

- When the batteries are fully charged, "Fully charged" is displayed.

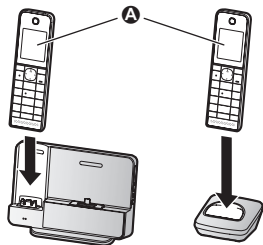

Note when setting up

Note for connections

- The AC adaptor must remain connected at all times. (It is normal for the adaptor to feel warm during use.)
- The AC adaptor should be connected to a vertically oriented or floor-mounted AC outlet. Do not connect the AC adaptor to a ceiling-mounted AC outlet, as the weight of the adaptor may cause it to become disconnected.

During a power failure

The unit will not work during a power failure. We recommend connecting a corded-type telephone (without AC adaptor) to the same telephone line or to the same telephone line jack using a Panasonic T-adaptor (page 3).

Note for battery installation

- Use the supplied rechargeable batteries. For replacement, we recommend using the Panasonic rechargeable batteries noted on page 3, 7.

Note for battery charging

- It is normal for the handset to feel warm during charging.
- Clean the charge contacts of the handset, base unit, and charger with a soft and dry cloth once a month. Before cleaning the unit, disconnect from power outlets and any telephone line cords. Clean more often if

the unit is exposed to grease, dust, or high humidity.

Battery level

Icon	Battery level
	High
	Medium
	Low
	Needs charging.
	Empty

Panasonic Ni-MH battery performance (supplied batteries)

Operation	Operating time
In continuous use	10 hours max.*1
Not in use (standby)	6 days max.*1

*1 If eco mode is on.

Note:

- Actual battery performance depends on usage and ambient environment.

Intelligent eco mode

This feature automatically reduces handset power consumption by suppressing handset transmission power when the handset is close to the base unit.

- When this feature is activated, **ECO** is displayed.
- Eco mode is turned off when the clarity booster is activated (page 23).

Controls

Handset

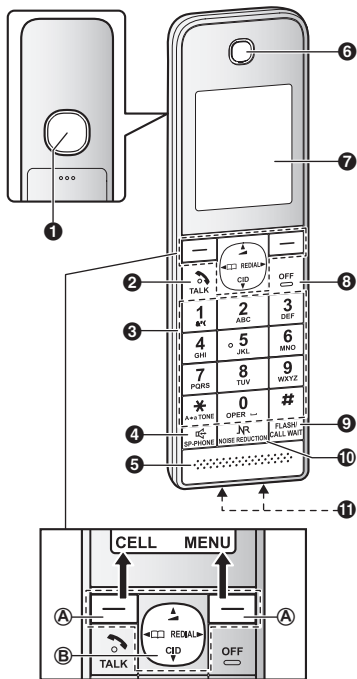

- 1 Speaker
- 2 [TALK]
- 3 Dial keypad (TONE)
- 4 [SP-PHONE: Speakerphone]
- 5 Microphone
- 6 Receiver
- 7 Display
- 8 [OFF]
- 9 [FLASH][CALL WAIT]
- 10 [NR] (NOISE REDUCTION/Smart function key)
NR indicator
- 11 Charge contacts

Control type

A Soft keys

By pressing a soft key, you can select the feature shown directly above it on the display. After a cellular phone is paired, [CELL] is displayed.

B Navigator key

- [▲], [▼], [◀], or [▶]: Scroll through various lists and items.
- ◀ (Volume: [▲] or [▼]): Adjust the receiver or speaker volume while talking.
- [◀] [□]: View the phonebook entry.
- [▶] REDIAL: View the redial list.
- [▼] CID (Caller ID): View the caller list.

Base unit

■ KX-PRL260 series: page 3

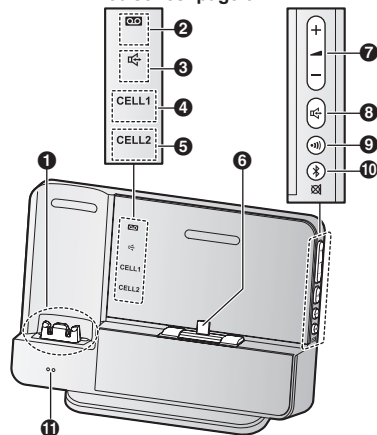

- 1 Charge contacts
- 2 [Answer on/off, Message] indicator
- 3 [Speakerphone] indicator
- 4 CELL 1 indicator
- 5 CELL 2 indicator
- 6 Lightning™ connector
- 7 [Volume: [+] or [-]]
- 8 [Speakerphone]
- 9 [Locator/Intercom]
 - You can locate a misplaced handset by pressing [Locator/Intercom].

- 10 (Bluetooth pairing)
- (Mute)
- 11 Microphone
- KX-PRD260 series: page 3

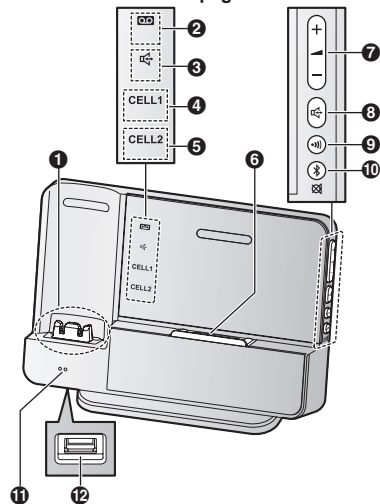

- 1 Charge contacts
- 2 (Answer on/off, Message) indicator
- 3 (Speakerphone) indicator
- 4 CELL 1 indicator
- 5 CELL 2 indicator
- 6 USB cable slot (page 14)
- 7 (Volume: [+] or [-])
- 8 (Speakerphone)
- 9 (Locator/Intercom)
 - You can locate a misplaced handset by pressing .
- 10 (Bluetooth pairing)
- (Mute)
- 11 Microphone
- 12 USB port (rear of unit)

Charging your smartphone

KX-PRL260 series: page 3

You can charge your smartphone by placing it on the Lightning connector. This connection is for charging only; data is not exchanged with the base unit.

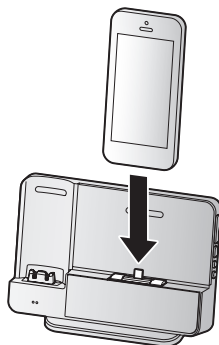

Note:

- You may need to remove your smartphone from its case in order to establish a secure connection with the Lightning connector.

KX-PRD260 series: page 3

You can connect a USB cable (not supplied) to the rear of the base unit and use it to charge your smartphone. This connection is for charging only; data is not exchanged with the base unit.

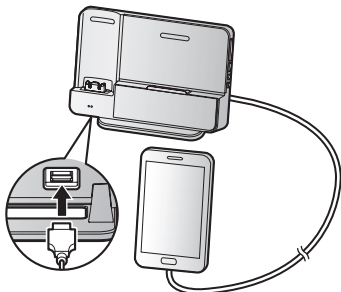

Getting Started

- If your smartphone's USB port is located at the center of its bottom panel

You can also run a USB cable (not supplied) through the cable slot (A) and place your smartphone on the base unit for charging.

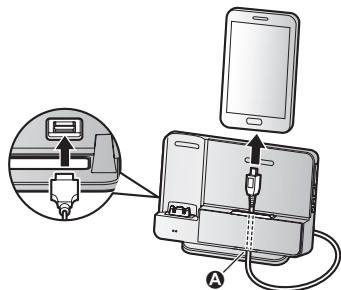

Note:

- Certain smartphones may not be able to be charged via USB.

Display icons/Indicators

Handset display items

Item	Meaning
	Within base unit range
	Out of base unit range
	The landline is in use. <ul style="list-style-type: none"> ● When flashing: The call is put on hold. ● When flashing rapidly: An incoming call is now being received.
	A cellular line is in use. <ul style="list-style-type: none"> ● When flashing: The cellular call is put on hold. ● When flashing rapidly: A cellular call is being received.

Item	Meaning
	A cellular phone is connected.*1 Ready to make/receive cellular calls. <ul style="list-style-type: none"> ● When turned off: A cellular phone is not connected to the base unit. (page 19)
C1 C2	<ul style="list-style-type: none"> – A cellular call is being done on that line. – The cellular line is selected for the setting.
ECO	Eco mode is on. (page 11)
NR	Noise reduction is set. (page 23)
EQ	Equalizer is set. (page 24)
	Speakerphone is on. (page 21)
	Answering system is on. (page 51)
	Ringer volume is off.*2 (page 34, 35)
Zz	Silent mode is on. (page 40)
PRIV.	Call sharing mode is off. (page 37)
	Alarm is on. (page 39)
1	Handset number
	Battery level
	Blocked call (page 40)
Booster on	Clarity booster is on. (page 23)
	Music player feature is being used. (page 48)
In use	Answering system is being used by another handset.
Cell11 in use	Someone is using the corresponding line.
Cell12 in use	
Line in use	

- *1 Corresponding cellular line(s) is(are) indicated next to the item.
- *2 Corresponding lines (1, 2: cellular line, L: landline) are indicated next to the item. If all lines are turned off, no line is indicated.

CELL indicators on the base unit

The CELL indicators show each cellular line status.

Status	Meaning
On	A cellular phone is connected. Ready to make/receive cellular calls.
Flashing	<ul style="list-style-type: none"> – The cellular line is in use. – Phonebook entries are being copied from a cellular phone (page 47). – The base unit is searching for the paired cellular phone. – The base unit is pairing a cellular phone. – A cellular call is put on hold.
Flashing rapidly	A cellular call is being received.
Light off	<ul style="list-style-type: none"> – A cellular phone is not paired to the base unit. – A cellular phone is not connected to the base unit (page 19).

Language settings

Display language

You can select either “English” or “Español” as the display language. The default setting is “English”.

- [MENU]** (right soft key) **#1110**
- [↕]**: Select the desired setting. → **[SAVE]**
- [OFF]**

Voice guidance language

You can select either “English” or “Español” as the voice guidance language of the answering system. The default setting is “English”.

- [MENU]** (right soft key) **#1112**
- [↕]**: Select the desired setting.
- [SAVE]** → **[OFF]**

Date and time

- [MENU]** (right soft key) **#1101**
- Enter the current month, date, and year by selecting 2 digits for each.
Example: July 15, 2014
07 15 14
- [OK]**
- Enter the current hour and minute (12-hour clock format) by selecting 2 digits for each.
Example: 9:30
09 30
- [*]**: Select “AM” or “PM”.
- [SAVE]** → **[OFF]**

Note:

- When English is selected as the display language, 12-hour clock format is used. When Spanish is selected, 24-hour clock format is used.

Recording your greeting message

You can record your own greeting message instead of using a pre-recorded greeting message. See page 51 for details.

- [MENU]** (right soft key) **#302**
- [↕]**: “Yes” → **[SELECT]**
- Record a greeting message. → **[STOP]** → **[OFF]**

Other settings

Smart function key (NR key)

The Smart function key (NR key) is located on the bottom of the handset and informs you with its flashing to allow you to activate the following features by simply pressing this key.

■ **When the NR indicator flashes rapidly, you can:**

- Answer the call (outside call, intercom). (page 22, 26)
- Stop the alarm sound. (page 40)

■ **When the NR indicator flashes slowly in standby mode, you can:**

- Listen to new messages. (page 52)
- Listen to new voice mail messages. (page 59)
- View the caller list when there are missed calls. (page 45)

To activate these features, their Smart function key must be "On". (page 16)

Using the Smart function key (NR key)

When the NR indicator flashes rapidly/slowly, press [NR].

- The above features can be activated depending the situation.
- If you answer a call using the Smart function key, the speakerphone is activated.
- Even if the handset is placed on the base unit or charger, the feature can be activated. You can talk or listen to new messages without lifting up the handset. If you want to perform further operations, lift up the handset.
- When the unit has new messages, new voice mail messages, and missed calls, the unit can be operated to play the new messages first, play the new voice mail messages next, and then show the missed calls.

Setting the Smart function key

The Smart function key for the following features must be "On".

- "New message" (Default: On)
- "New VM" (Default: On)
- "Missed call" (Default: Off)

The settings can be set for each handset.

- 1 [MENU] (right soft key) [#278]
- 2 [↕]: Select the desired setting and press [SELECT].
 - "✓" is displayed next to the selected features.
 - To cancel a selected feature, press [SELECT] again. "✓" disappears.
- 3 [SAVE] → [OFF]

Note:

- If the NR indicator flashes when the handset is not placed on the base unit or charger, battery consumption is faster than usual.

Dialing mode

If you cannot make calls, change this setting according to your telephone line service. The default setting is "Tone".

"Tone": For tone dial service.

"Pulse": For rotary/pulse dial service.

- 1 [MENU] (right soft key) [#120]
- 2 [↕]: Select the desired setting.
- 3 [SAVE] → [OFF]

Screen saver mode

The backlight goes dark when on a call or turns off completely after 1 minute of inactivity if the handset is not on the base unit or charger.

Activate the handset display again by:

- pressing [📞] when on a call.
- pressing [OFF] at all other times.

Link to cell feature

You can connect your base unit and cellular phone using Bluetooth wireless technology, so that you can make or answer cellular calls using your phone system.

This allows you to:

- use the unit to talk on cellular calls even if some areas of your home have poor cellular reception, simply by placing your cellular phone in an area with good reception.
- talk on cellular calls even if your cellular phone is in your pocket or bag.
- enjoy cordless cellular calls even if your cellular phone plugged in and charging.

Important:

- You may pair a maximum of 2 cellular phones. However, the base unit allows only one Bluetooth to be active at a time.
- The unit may not function properly with your Bluetooth device's phone app depending on your Bluetooth device model, the devices connected to your Bluetooth device, and the apps installed on your Bluetooth device.
- Your cellular phone must support the Hands Free Profile (HFP) specification.

Pairing a cellular phone

Important:

- For more details and the list of compatible cellular phones, please visit our Web site: <http://www.panasonic.com/link2cell>
- Before pairing a Bluetooth enabled cellular phone to the base unit, make sure that no other Bluetooth device is connected to your cellular phone.

1 Handset:

For CELL 1: **[MENU]** (right soft key)

6 2 4 1

For CELL 2: **[MENU]** (right soft key)

6 2 4 2

- After the corresponding CELL indicator on the base unit starts flashing, the rest of the procedure must be completed within 5 minutes.

2 Your cellular phone:

While the corresponding CELL indicator is flashing, follow the instructions of your cellular phone to enter the pairing mode.

- Depending on your cellular phone, it may ask you to enter the Bluetooth PIN (default: "0000"). If your cellular phone shows PassKey confirmation on its display, follow the directions to proceed.

3 Handset:

Wait until a long beep sounds.

- It may take more than 10 seconds to complete pairing.
- When the corresponding CELL indicator lights up, the cellular phone is connected to the base unit. You are ready to make cellular calls.

4 [OFF]

Note:

- Make sure that your cellular phone is set to connect to this product automatically. Refer to your cellular phone's operating instructions.
- Make sure you cancel your cellular phone's current pairing if you want to pair it to the other line (page 17).
- The default setting for the text message alert feature is "On (no announce)", so when you pair your cellular phone to the base unit, this feature may be activated (page 49). (This depends on the version and type of cellular phone you are using.)

Unpairing a cellular phone

You can cancel the pairing of a cellular phone that is stored in the base unit.

1 For CELL 1: **[MENU]** (right soft key)

6 1 1 1

For CELL 2: **[MENU]** (right soft key)

6 1 1 2

2 **[↕]**: "Yes" → **[SELECT]**

- When the cellular phone is unpaired, the CELL indicator is turned off.

3 [OFF]

Link to cell settings

Selecting which unit receives cellular calls

You can select which unit rings and receives calls for a cellular line. When "All" is selected, all handsets and the base unit ring.

- 1 For CELL 1: **[MENU]** (right soft key)
6 2 7 1
For CELL 2: **[MENU]** (right soft key)
6 2 7 2
- 2 **[↕]**: Select the desired handset or "All".
→ **[SAVE]**
- 3 **[OFF]**

Note:

- When you select a specific handset to receive calls for a cellular line:
 - other handsets cannot answer the calls.
 - the base unit can answer the calls even though it does not ring. However, you can make the base unit ring by adjusting the base unit ringer volume (page 34).
- When you change the setting to "All", the base unit ringer volume also returns to the lowest level even if the ringer volume has been changed.
- The units selected with this setting have the text message alert feature (page 49) applied to them.

Ring as cell mode

Once this feature is turned on, the handset and base unit ring using the same ringer tone as your cellular phone.

The following settings are available:

- "Off": Turn this feature off to use the ringer tones of the handset and base unit. Caller information is announced depending on the Talking Caller ID setting (page 36).
- "On (with Talking CID)": (default): The handset and base unit use your cellular phone's ringer tone. Caller information is announced even if the Talking Caller ID is turned off.
- "On (without Talking CID)": The handset and base unit use your cellular

phone's ringer tone. Caller information is not announced even if the Talking Caller ID is turned on.

Important:

- To use this feature, your cellular phone must support Bluetooth in-band ringtone. Refer to your cellular phone's operating instructions.

- 1 For CELL 1: **[MENU]** (right soft key)
6 1 4 1
For CELL 2: **[MENU]** (right soft key)
6 1 4 2
- 2 **[↕]**: Select the desired setting.
- 3 **[SAVE]** → **[OFF]**

Note:

- The units use the preset ringer tones (page 35) instead of your cellular phone's ringer tone when a cellular call is being received if:
 - your cellular phone is in silent mode (depending on your cellular phone).
 - the base unit is in use.
 - 2 handsets are sharing a landline call.
- If your cellular phone is in silent mode with "On (with Talking CID)" set, the unit announces caller information even when Talking Caller ID is turned off (page 36).

To use the handset ringer tone instead of your cellular phone's ringer tone

Select "off" in step 2, "Ring as cell mode", page 18.

To change the handset ringer tone for a cellular line, see page 34.

Auto connection to the Bluetooth devices (cellular phones)

After pairing, your Bluetooth devices are connected to the base unit. If you move the Bluetooth devices out of base unit range, the Bluetooth devices are disconnected from the base unit. This feature allows the base unit to try to reconnect the cellular phone at regular intervals when it returns within base unit

range. You can set the interval. The default setting is "1 min".

Important:

- When you are using a cellular line, the base unit loses its connection from other Bluetooth devices (cellular phone). To automatically resume the connection to cellular phones, leave the auto connection on.
- Some cellular phones lose connection after usage, please check the specifications of your cellular phone for more details.

- 1 **[MENU]** (right soft key) **#632**
- 2 **[↓]**: Select the desired setting.
- 3 **[SAVE] → [OFF]**

Note:

- Some cellular phones may ask you if you accept the connection requirement from the base unit. In that case, select "Off" in step 2. Check the specifications of your cellular phone.

Connecting/disconnecting the cellular phone manually

If you will not be using the paired cellular phone's link to cell feature temporarily (for example, you do not want the unit to ring when your cellular line receives a call), you can disconnect your cellular phone from the base unit. If you want to use it again, reconnect the cellular phone to the base unit.

Note:

- Even if a paired cellular phone was disconnected from the base unit, if it is brought within the base unit's range during the auto connection interval, it may automatically connect to the base unit (page 18).
- A disconnected cellular phone is not unpaired from the base unit, so pairing it to the base unit again is unnecessary.

Base unit

You can search for a cellular phone that is paired to the base unit and connect to it easily.

Important:

- This feature is available when Bluetooth is not in use and neither the cellular phone nor the unit are talking on a call.

Press **[*]** and wait for a few seconds for the cellular phone and base unit to connect to each other.

Handset

- 1 **To connect/disconnect:**
For CELL 1: **[MENU]** (right soft key)
#6251
For CELL 2: **[MENU]** (right soft key)
#6252
 - A long beep sounds.
- 2 **[OFF]**

Cellular line only mode (If you do not use the landline)

If you do not use the landline, we recommend setting the unit to the cellular line only mode.



Important:

- If you turn on the "Cell line only mode", disconnect the telephone line cord from the base unit. Otherwise the "Cell line only mode" cannot be activated.

- 1 **[MENU]** (right soft key) **#157**
- 2 **To turn on:**
[↓]: "On" → **[SELECT]** →
[↓]: "Yes" → **[SELECT]**
To turn off:
[↓]: "Off" → **[SELECT]**

Note:

- Once you set this mode, you can use the following buttons to make cellular calls for the handset, press **[📞]** or **[📞]** instead of **[CELL]** (page 21).
- Once you set this mode, the following features cannot be used:
 - Landline features (page 38)
 - Answering system (page 51)
Messages cannot be received.
 - Voice mail features (page 58)
- After this mode is turned on or off, the base unit reboots.



- Bluetooth connections from cellular phones are disconnected. If the auto connection is turned on (page 18), the cellular phones are reconnected.
-  will be displayed on the handset momentarily. The handset can be used once  is displayed.

When you use the landline again

Before connecting the telephone line to the base unit, select "Off" in step 2, "Cellular line only mode (If you do not use the landline)", page 19.

Cellular line selection

This feature determines which cellular line is selected to make cellular calls when:

- you press **[CELL]** on the handset.
- you press  or  on the handset while the cellular line only mode is turned on.

The following settings are available:

- "Manual" (default): You can select the desired cellular line when making a call.
- "Cellular phone 1"*1: CELL 1 is selected.
- "Cellular phone 2"*1: CELL 2 is selected.

1 [MENU] (right soft key) 

2 : Select the desired setting.

3 [SAVE] → **[OFF]**

*1 After the Bluetooth device is paired, the device name is displayed.

Storing your area code (for dialing only a 7-digit phone number to make a local call)

You need to add your area code when making cellular calls to a phone number in your area.

Once you store your area code, it is automatically added to the beginning of the 7-digit phone number when making cellular calls.

1 [MENU] (right soft key) 

2 Enter the 3-digit area code.
• To correct a digit, press **[CLEAR]**.

3 [SAVE] → **[OFF]**

Changing the Bluetooth PIN (Personal Identification Number)

The PIN is used to pair cellular phones to the base unit. The default PIN is "0000". To prevent unauthorized access to this product, we recommend that you change the PIN, and keep it confidential.

Important:

- Please make note of your new PIN. The unit does not reveal the PIN to you. If you forget your PIN, see page 68.

- 1 [MENU]** (right soft key) 
 - If the unit prompts you to enter the old PIN (when the default has been changed), enter the current 4-digit PIN.
- 2** Enter the new 4-digit PIN. → **[OK]**
- 3** Enter the new 4-digit PIN again. → **[SAVE]**
- 4 [OFF]**

Making cellular calls

Important:

- Only 1 cellular line can be used at a time.
- Before making calls, confirm that the corresponding CELL indicator on the base unit lights up (page 15).

- 1 Lift the handset and dial the phone number.
 - To correct a digit, press **[CLEAR]**.
- 2 **[CELL]**
 - The unit starts dialing when:
 - only 1 cellular phone is paired.
 - a specific line is set to make cellular calls (page 20).
 Go to step 4.
- 3 **[↕]**: Select the desired cellular phone. → **[SELECT]**
- 4 When you finish talking, press **[OFF]** or place the handset on the base unit or charger.

Note:

- To switch to the speaker, press **[📞]**.
- To switch back to the receiver, press **[📞]/[📞]**.

Adjusting the receiver or speaker volume

Press **[▲]** or **[▼]** repeatedly while talking.

Making a cellular call using the redial list

The last 5 phone numbers dialed are stored in the redial list (each 48 digits max.).

- 1 **[▶]** REDIAL
- 2 **[↕]**: Select the desired entry.
- 3 **[CELL]**
 - The unit starts dialing when:
 - only 1 cellular phone is paired.
 - a specific line is set to make cellular calls (page 20).
- 4 **[↕]**: Select the desired cellular phone. → **[SELECT]**

Erasing a number in the redial list

■ When a cellular phone is paired:

- 1 **[▶]** REDIAL
- 2 **[↕]**: Select the desired entry. → **[MENU]**
- 3 **[↕]**: “Erase” → **[SELECT]**
- 4 **[↕]**: “Yes” → **[SELECT]**
- 5 **[OFF]**

■ When a cellular phone is not paired:

- 1 **[▶]** REDIAL
- 2 **[↕]**: Select the desired entry. → **[ERASE]**
- 3 **[↕]**: “Yes” → **[SELECT]**
- 4 **[OFF]**

Making landline calls

- 1 Lift the handset and dial the phone number.
 - To correct a digit, press **[CLEAR]**.
- 2 **[📞]**
- 3 When you finish talking, press **[OFF]** or place the handset on the base unit or charger.

Using the speakerphone

- 1 Dial the phone number and press **[📞]**.
- 2 When you finish talking, press **[OFF]**.

Note:

- To switch back to the receiver, press **[📞]/[📞]**.

Making a call using the redial list

The last 5 phone numbers dialed are stored in the redial list (each 48 digits max.).

- 1 **[▶]** REDIAL
- 2 **[↕]**: Select the desired entry.
- 3 **[📞]**

Pause (for PBX/long distance service users)

A pause is sometimes required when making calls using a PBX or long distance service. When storing a calling card access number and/or PIN in the phonebook, a pause is also needed (page 30).

Example: If you need to dial the line access number "9" when making outside calls with a PBX:

- 1 **[9]** → **[▲]** (Pause)
- 2 Dial the phone number. → **[📞]**

Note:

- A 3.5 second pause is inserted each time **[▲]** (Pause) is pressed.

Answering calls

Using the handset

- 1 Lift the handset and press **[📞]** or **[📞]** when the unit rings.
 - To answer a cellular call, you can also press **[CELL]**.
- 2 When you finish talking, press **[OFF]** or place the handset on the base unit or charger.

Any key answer: You can answer the call by pressing any dial key.

Auto talk: You can answer calls simply by lifting the handset (page 37).

Temporary handset ringer off: You can turn the ringer off temporarily by pressing **[🔇]**.

Using the Smart function key

When the **NR** indicator flashes rapidly, press **[NR]**.

- You can answer the call even if the handset is placed on the base unit or charger (page 16).
You can finish talking by pressing **[OFF]** without lifting up the handset.

Adjusting the handset ringer volume

Press **[▲]** or **[▼]** repeatedly to select the desired volume while ringing.

Using the base unit

When a landline call is being received, the **📞** indicator flashes rapidly. When a cellular call is being received, the **CELL 1** or **CELL 2** indicator and **📞** indicator flash rapidly.

- 1 Press **[📞]** when the unit rings.
- 2 Speak into the microphone.
- 3 When you finish talking, press **[📞]**.

Adjusting the base unit ringer volume

Press **[+]** or **[-]** repeatedly to select the desired volume while ringing.

- To turn the ringer off, press and hold **[-]** until the unit beeps.

Adjusting the base unit speaker volume

Press **[+]** or **[-]** repeatedly while talking.

Useful features during a call

Hold

- 1 Press **[MENU]** during an outside call.
 - 2 **[📞]**: "Hold" → **[SELECT]**
 - 3 **To release hold on the cellular line:**
Press **[CELL]**.
 - Another handset user can take the call: **[CELL]**1** → **[SELECT]**
 - *1 The call is taken when:
 - only 1 cellular phone is paired.
 - a specific line is set to make cellular calls (page 20).
 - The base unit user can take the call by pressing **[📞]**.
- To release hold on the landline:**
Press **[📞]**.

- Another handset user can take the call by pressing [**📞**].
- The base unit user can take the call by pressing [**📞**].

Note:

- After holding for 10 minutes, the call is disconnected.

Mute

Handset

- 1 Press [**MUTE**] during a call.
 - [**MUTE**] flashes.
- 2 To return to the call, press [**MUTE**].

Note:

- [**MUTE**] is a soft key visible on the display during a call.

Base unit

- 1 Press [**📞**] during conversation.
 - 📞 indicator flashes.
- 2 To return to the conversation, press [**📞**].

Flash for landline calls

[**FLASH**] allows you to use the special features of your host PBX such as transferring an extension call, or accessing optional telephone services.

Note:

- To change the flash time, see page 37.

For call waiting or Call Waiting Caller ID service users

To use call waiting or Call Waiting Caller ID, you must first subscribe with your service provider/telephone company.

This feature allows you to receive calls while you are already talking on the phone. If you receive a call while on the phone, you will hear a call waiting tone.

If you subscribe to both **Caller ID** and **Call Waiting with Caller ID services**, the 2nd caller's information is displayed after you hear the call waiting tone on the handset.

- 1 Press [**CALL WAIT**] to answer the 2nd call.
- 2 To switch between calls, press [**CALL WAIT**].

Note:

- If you receive a call while you are using the base unit to talk on a call, a call waiting tone is heard. Press [**📞**], then press [**📞**] while the 2nd call is being received. Note that the current call will be disconnected.
- Please contact your service provider/telephone company for details and availability of this service in your area.

Temporary tone dialing for landline calls (for rotary/pulse service users)

Press [**☒**] (TONE) before entering access numbers which require tone dialing.

Handset clarity booster

This feature can improve sound clarity when the handset is used in an area where there may be interference. During an outside call, this feature is turned on automatically when necessary.

- When this feature is turned on, “**Booster on**” is displayed.

Handset noise reduction

This feature allows you to hear the voice of the person you are talking to clearly, by reducing the surrounding noise coming from the other party's telephone.

Press [**NR**] to turn on/off while talking.

Note:

- Depending on the environment where this handset is being used, this feature may not be effective.
- This feature is not available using the speakerphone.

Handset equalizer

This feature clarifies the voice of the person you are talking to, producing a more natural-sounding voice that is easier to hear and understand.

- 1 Press **[MENU]** while talking.
- 2 **[↕]**: "Equalizer" → **[SELECT]**
- 3 **[↕]**: Select the desired setting.
- 4 Press **[OK]** to exit.

Note:

- Depending on the condition and quality of your telephone line, this feature may emphasize existing line noise. If it becomes difficult to hear, turn this feature off.
- This feature is not available while using the speakerphone.
- When both the "Equalizer" setting and noise reduction are activated, **NR** is shown on the display.

Call share

You can join an existing outside call.

■ While another unit is on a cellular call:

Handset

- 1 To join the conversation, press **[CELL]**.
 - You can join the conversation when:
 - only 1 cellular phone is paired.
 - a specific line is set to make cellular calls (page 20).
- 2 **[↕]**: Select the desired cellular phone. → **[SELECT]**

Base unit

To join the conversation, press **[☎]**.

■ While another unit is on a landline call:

Handset

To join the conversation, press **[☎]**.

Base unit

To join the conversation, press **[☎]**.

Note:

- A maximum of 3 parties (including 1 outside party) can join a conversation using 2 extensions. **(3-way conference)**
- To prevent other users from joining your conversations with outside callers, turn call sharing mode off (page 37).

Transferring calls, conference calls

Outside calls can be transferred or a conference call*1 with an outside party can be made:

- between 2 handsets
- between a handset and the base unit

*1 A conference call can be established using the handset only.

Handset

- 1 During an outside call, press **[MENU]**.
- 2 **[↕]**: "Intercom" → **[SELECT]**
- 3 **[↕]**: Select the desired unit. → **[SELECT]**
- 4 Wait for the paged party to answer.
 - If the paged party does not answer, press **[☎]** to return to the outside call.
- 5 **To complete the transfer:**
Press **[OFF]**.
To establish a conference call:
[MENU] → **[↕]**: "Conference" → **[SELECT]**
 - To leave the conference, press **[OFF]**.
The other 2 parties can continue the conversation.
 - To put the outside call on hold:
[MENU] → **[↕]**: "Hold" → **[SELECT]**
To resume the conference: **[MENU]** → **[↕]**: "Conference" → **[SELECT]**
 - To cancel the conference: **[MENU]** → **[↕]**: "Stop conference" → **[SELECT]**
You can continue the conversation with the outside caller.

Base unit

- 1 During an outside call, press **[📞]**.
 - All registered handsets beep.
- 2 Wait for the paged party to answer.
 - If the paged party does not answer, press **[📞]** to return to the outside call.
- 3 To complete the transfer, press **[📞]**.

Transferring a cellular call between the handset and a cellular phone

Transferring a cellular call from the handset to a cellular phone

- 1 Press **[MENU]** during a cellular call.
- 2 **[↕]**: "Transfer to cell" → **[SELECT]**
 - The cellular call is transferred to the cellular phone.

Note:

- Depending on your cellular phone type, you may need to set the cellular phone to be ready to talk before transferring. For example, if your cellular phone has a top cover, open it beforehand.

Transferring a cellular call from a cellular phone to the handset

During a conversation using a cellular phone, the call cannot be transferred to the handset by the cellular phone. Perform the following with the handset.

- 1 During a conversation using a cellular phone, press **[CELL]**.
 - In the following cases, go to step 3.
 - when only 1 cellular phone is paired.
 - when a specific line is set to make cellular calls (page 20).
- 2 **[↕]**: Select the desired cellular phone. → **[SELECT]**
- 3 **[↕]**: "Transfer from cell" → **[SELECT]**
 - The call is transferred to the handset.

Note:

- When you press **[OFF]** on the handset to end the phone app's cellular call, the call is transferred to the cellular phone. Use the cellular phone to disconnect the call. Depending on the phone app, the call may be disconnected without being transferred to the cellular phone.

Transferring a cellular call between the base unit and a cellular phone

Transferring a cellular call from the base unit to a cellular phone

During a cellular call, press and hold **[*]** until the **[📞]** indicator goes out.

- The cellular call is transferred to the cellular phone.

Transferring a cellular call from a cellular phone to the base unit

During a conversation using a cellular phone, press **[📞]**.

- The cellular call is transferred to the base unit.

Note:

- When you press **[📞]** on the base unit to end the phone app's cellular call, the call is transferred to the cellular phone. Use the cellular phone to disconnect the call. Depending on the phone app, the call may be disconnected without being transferred to the cellular phone.

Answering a 2nd call

If you receive a call while talking on the phone, the interrupt tone sounds (page 35), and the 2nd caller's information is displayed on the handset if you subscribe to Caller ID (page 44).

Answering a 2nd call during a landline call

Handset

- 1 Press **[MENU]** during a landline call.
- 2 **[⇩]**: "Hold" → **[SELECT]**
- 3 **To answer the 2nd call:**
Press **[CELL]** while the 2nd call is being received.
- 4 To hang up the 2nd call and return to the 1st call (landline call), press **[OFF]**, then press **[↶]**.

Base unit

Press **[📞]**, then press **[📞]** while the 2nd call is being received.

- Note that the current call is disconnected.

Answering a 2nd call during a cellular call

Handset

- 1 Press **[MENU]** during a cellular call.
- 2 **[⇩]**: "Hold" → **[SELECT]**
- 3 **To answer the 2nd call:**
[↶]
- 4 To hang up the 2nd call and return to the 1st call (cellular call), press **[OFF]**, then press **[CELL]**.

Base unit

Press **[📞]**, then press **[📞]** while the 2nd call is being received.

- Note that the current call is disconnected.

Intercom

Intercom calls can be made:

- between handsets
- between a handset and the base unit

Note:

- When paging unit(s), the paged unit(s) beeps for 1 minute.

- If you receive an outside call while talking on the intercom, the interrupt tone sounds (page 35).
 - To answer the call with the handset, press **[OFF]**, then press the corresponding line key.
 - To answer the call with the base unit, press **[📞]** 2 times.

Making an intercom call

Handset

- 1 **[MENU]** (right soft key) → **[📞]** → **[SELECT]**
- 2 **[⇩]**: Select the desired unit. → **[SELECT]**
- 3 When you finish talking, press **[OFF]**.

Note:

- You can also use the **[INTERCOM]** soft key, if displayed, to make intercom calls.

Base unit

- 1 **[📞]**
 - All registered handsets beep.
- 2 When you finish talking, press **[📞]**.

Answering an intercom call

Handset

- 1 Press **[↶]** to answer the page.
- 2 When you finish talking, press **[OFF]**.

Base unit

- 1 Press **[📞]** to answer the page.
- 2 When you finish talking, press **[📞]**.

Using the Smart function key

Press **[NR]** to answer the page.

Phonebook

You can store up to 3,000 phonebook entries and assign a name (16 characters max.) and up to 3 phone numbers to each (24 digits max. each). You can also assign a label to each phone number, and assign each phonebook entry to a group (page 28). The following groups are available:

- Group 1: "Home"^{*1} (default)
- Group 2: "Cell 1"^{*1}
- Group 3: "Cell 2"^{*1}
- Group 4-9: You can change the group name for each group.

*1 For groups 1-3, the group names cannot be changed.

The total number of entries that can be stored varies depending on how many phone numbers you have stored for each entry. Total number of entries is shown below:

- 1 name + 1 phone number: 3,000 entries
- 1 name + 2 phone numbers: 1,500 entries
- 1 name + 3 phone numbers: 1,000 entries

Important:

- All entries can be shared by any registered handset.
- You can copy phonebook entries from a Bluetooth cellular phone to the unit's phonebook (page 47).

Adding phonebook entries

- 1 [←] □ → [MENU]
- 2 [↕]: "Add new entry" → [SELECT]
- 3 [↕]: "(Name)" → [SELECT]
- 4 Enter the party's name. → [OK]
- 5 [↕]: Select the desired phone number location. → [SELECT]
- 6 Enter the party's phone number. → [OK]
- 7 [↕]: Select the desired label. → [SELECT]
 - To store 2 or 3 phone numbers, repeat steps 5-7.
- 8 [↕]: Select the current setting of the group (default: "Home"). → [SELECT]

- 9 [↕]: Select the desired group. → [SELECT]

- 10 [↕]: "<Save>" → [SELECT] → [OFF]

Storing a redial list number to the phonebook

Phone numbers of up to 24 digits can be stored in the phonebook.

■ When a cellular phone is paired:

- 1 [▶] REDIAL
- 2 [↕]: Select the desired entry. → [MENU]
- 3 [↕]: "Save" → [SELECT]
- 4 To store the name, continue from step 3, "Editing entries", page 29.

■ When a cellular phone is not paired:

- 1 [▶] REDIAL
- 2 [↕]: Select the desired entry. → [DETAIL]
- 3 [SAVE]
- 4 To store the name, continue from step 3, "Editing entries", page 29.

Storing caller information to the phonebook

■ When a cellular phone is paired:

- 1 [▼] CID
- 2 [↕]: Select the desired entry. → [MENU]
 - To edit the number: [↕]: "Edit" → [SELECT]
Press [EDIT] repeatedly until the phone number is shown in the desired format. And then, press [X] (Save). Go to step 4.
- 3 [↕]: "Save caller ID" → [SELECT]
- 4 [↕]: "Phonebook" → [SELECT]
- 5 Continue from step 3, "Editing entries", page 29.

■ When a cellular phone is not paired:

- 1 [▼] CID

- 2 **[↕]**: Select the desired entry. → **[MENU]**
 - To edit the number: **[↕]**: "Edit" → **[SELECT]**
Press **[EDIT]** repeatedly until the phone number is shown in the desired format. And then, press **[SAVE]**. Go to step 4.
- 3 **[↕]**: "Save caller ID" → **[SELECT]**
- 4 **[↕]**: "Phonebook" → **[SELECT]**
- 5 Continue from step 3, "Editing entries", page 29.

Character table for entering names

While entering characters, you can switch between uppercase and lowercase by pressing **[A→a]**.

Key	Character
[1]	& ' () * , - . / 1
[2]	A B C 2 a b c 2
[3]	D E F 3 d e f 3
[4]	G H I 4 g h i 4
[5]	J K L 5 j k l 5
[6]	M N O 6 m n o 6
[7]	P Q R S 7 p q r s 7
[8]	T U V 8 t u v 8
[9]	W X Y Z 9 w x y z 9
[0]	_ 0
[#]	#

- To enter another character that is located on the same dial key, first press **[▶]** to move the cursor to the next space.
- If you do not press any dial key within 5 seconds after entering a character, the character is fixed and the cursor moves to the next space.
- **[]** in the above table represents a single space.

Erasing the character or number

Press **[◀]** or **[▶]**. → **[CLEAR]**

- Press and hold **[CLEAR]** to erase all characters or numbers.

Groups

Groups can help you find entries in the phonebook quickly and easily. You can change the group name for groups 4-9 ("Friends", "Family", etc.). By assigning different ringer tones for different groups of callers, you can identify who is calling (ringer ID), if you have subscribed to Caller ID service.

Changing group names/setting ringer ID

- 1 **[◀]** **[]** → **[MENU]**
- 2 **[↕]**: "Group" → **[SELECT]**
- 3 **[↕]**: Select the desired group. → **[SELECT]**
 - If you selected "Home", "Cell 1", or "Cell 2", go to step 5.
- 4 **To change group names**
[↕]: "Group name" → **[SELECT]** → Edit the name (10 characters max.). → **[SAVE]**
- 5 **To set group ringer tone**
[↕]: Select the current setting of the group ringer tone. → **[SELECT]** → **[↕]**: Select the desired ringer tone. → **[SAVE]**
- 6 **[OFF]**

Finding and calling from a phonebook entry

- Using a cellular line:

1 [◀] □

2 To scroll through all entries

[↕]: Select the desired entry. → [CELL]

To search by first character

① Press the dial key ([0] to [9], or [#]) which contains the character you are searching for (page 28).

② [↕]: Scroll through the phonebook if necessary. → [CELL]

To search by query

You can narrow down the search to enter the first characters of a name.

① [*]

② To search for the name, enter the first characters (up to 4) in uppercase (page 28).

③ [OK]

④ [↕]: Scroll through the phonebook if necessary. → [CELL]

To search by group

① [GROUP]

② [↕]: Select the desired group. → [SELECT]

③ [↕]: Scroll through the phonebook if necessary. → [CELL]

3 [↕]: Select the desired phone number. → [CALL]

- The unit starts dialing when:
 - only 1 cellular phone is paired.
 - a specific line is set to make cellular calls (page 20).

4 [↕]: Select the desired cellular phone. → [SELECT]

■ Using the landline:

1 [◀] □

2 To scroll through all entries

[↕]: Select the desired entry. → [↵]

To search by first character

① Press the dial key ([0] to [9], or [#]) which contains the character you are searching for (page 28).

② [↕]: Scroll through the phonebook if necessary. → [↵]

To search by query

You can narrow down the search to enter the first characters of a name.

① [*]

② To search for the name, enter the first characters (up to 4) in uppercase (page 28).

③ [OK]

④ [↕]: Scroll through the phonebook if necessary. → [↵]

To search by group

① [GROUP]

② [↕]: Select the desired group. → [SELECT]

③ [↕]: Scroll through the phonebook if necessary. → [↵]

3 [↕]: Select the desired phone number. → [↵]

Editing entries

1 Find the desired entry (page 28). → [MENU]

2 [↕]: "Edit" → [SELECT]

3 [↕]: Select the desired item you want to change. → [SELECT]

4 To change the name:

Edit the name. → [OK]

To change the phone number:

① Edit the phone number. → [OK]

② [↕]: Select the desired label. → [SELECT]

To change the group:

[↕]: Select the desired group (page 28). → [SELECT]

5 [↕]: "<Save>" → [SELECT] → [OFF]

Erasing entries

Erasing an entry

1 Find the desired entry (page 28). → [MENU]

2 [↕]: "Erase" → [SELECT]

3 [↕]: "Yes" → [SELECT]

4 [OFF]

Erasing all entries

1 [◀] □ → [MENU]

2 [↕]: "Erase all" → [SELECT]

- 3 [↕]: Select the desired group. → [SELECT]
- 4 [↕]: "Yes" → [SELECT]
- 5 [↕]: "Yes" → [SELECT]
- 6 [OFF]

Chain dial

This feature allows you to dial phone numbers in the phonebook while you are on a call. This feature can be used, for example, to dial a calling card access number or bank account PIN that you have stored in the phonebook, without having to dial manually.

- 1 During an outside call:
[MENU] → [↕]: "Phonebook" → [SELECT]
- 2 [↕]: Select the desired entry. → [SELECT]
- 3 [↕]: Select the desired phone number.
- 4 Press [CALL] to dial the number.

Note:

- When storing a calling card access number and your PIN in the phonebook as one phonebook entry, press [▲] (Pause) to add pauses after the number and PIN as necessary (page 22).
- If you have rotary/pulse service, you need to press [✕] (TONE) before pressing [MENU] on the handset in step 1 to change the dialing mode temporarily to tone. When adding entries to the phonebook, we recommend adding [✕] (TONE) to the beginning of phone numbers you wish to chain dial (page 27).

Speed dial

You can assign 1 phone number to each of the dial keys ([1] to [9]) on the handset.

Adding phone numbers to speed dial keys

■ By entering phone numbers:

- 1 Press and hold the desired speed dial key ([1] to [9]). → [ADD]
- 2 [↕]: "Manual" → [SELECT]
- 3 Enter the party's name (16 characters max.). → [OK]
- 4 Enter the party's phone number (24 digits max.). → [OK]
- 5 [SELECT] → [OFF]

■ From the phonebook:

- 1 Press and hold the desired speed dial key ([1] to [9]). → [ADD]
- 2 [↕]: "Phonebook" → [SELECT]
- 3 [↕]: Select the desired entry. → [SELECT]
- 4 [↕]: Select the desired phone number. → [SAVE] → [OFF]

Note:

- If you edit a phonebook entry which is assigned to a speed dial key, the edited entry does not transfer to the speed dial key.

Editing an entry

- 1 Press and hold the desired speed dial key ([1] to [9]). → [MENU]
- 2 [↕]: "Edit" → [SELECT]
- 3 Edit the name if necessary. → [OK]
- 4 Edit the phone number if necessary. → [OK]
- 5 [SELECT] → [OFF]

Erasing an entry

- 1 Press and hold the desired speed dial key ([1] to [9]). → [MENU]
- 2 [↕]: "Erase" → [SELECT]
- 3 [↕]: "Yes" → [SELECT] → [OFF]

Viewing an entry/Making a call

■ Using a cellular line:

- 1 Press and hold the desired speed dial key ([1] to [9]).
- 2 **[CELL]**
 - The unit starts dialing when:
 - only 1 cellular phone is paired.
 - a specific line is set to make cellular calls (page 20).
- 3 **[↕]**: Select the desired cellular phone.
→ **[SELECT]**

■ Using the landline:

- 1 Press and hold the desired speed dial key ([1] to [9]).
- 2 **[📞]**

Menu list

To access the features, there are 2 methods.

■ Scrolling through the display menus

- 1 **[MENU]** (right soft key)
- 2 Press **[▼]**, **[▲]**, **[▶]**, or **[◀]** to select the desired main menu. → **[SELECT]**
- 3 Press **[▼]** or **[▲]** to select the desired item from the next sub-menus. → **[SELECT]**
- 4 Press **[▼]** or **[▲]** to select the desired setting. → **[SAVE]**

■ Using the direct command code

- 1 **[MENU]** (right soft key) → Enter the desired code.
Example: Press **[MENU]** (right soft key) **#101**.
- 2 Select the desired setting. → **[SAVE]**

Note:

- To exit the operation, press **[OFF]**.
- In the following table, < > indicates the default settings.
- In the following table,  indicates the reference page number.
- Display menu order and sub-menu may vary depending on your model.

Display menu tree and direct command code table

Main menu: **→** "Caller list"

Operation	Code	
Viewing the caller list.	#213	44

Main menu: **□□** "Answering device"

Sub-menu 1	Sub-menu 2	Settings	Code	
Message list	–	–	#329	52
Play new message	–	–	#323	52
Play all message	–	–	#324	52
Erase all message* ¹	–	–	#325	53
Greeting	Record greeting* ¹	–	#302	51
	Check greeting	–	#303	52
	Pre-recorded* ¹ (Reset to pre-recorded greeting)	–	#304	51

Sub-menu 1	Sub-menu 2	Settings	Code	
New message alert ^{*1}	Outgoing call – On/Off	On <Off>	#338	53
	Outgoing call – Notification to	–		
	Outgoing call – Remote code	Activate <Inactivate>		
	Base unit beep	On <Off>	#339	53
Settings	Ring count ^{*1}	2-7 rings <4 rings> Toll saver	#211	56
	Recording time ^{*1}	1 min <3 min> Greeting only ^{*2}	#305	56
	Remote code ^{*1}	<111>	#306	54
	Screen call – Handset	<On> Off	#310	56
	Screen call – Base unit	<On> Off	#*310	
Answer on ^{*1}	–	–	#327	51
Answer off ^{*1}	–	–	#328	51

Main menu:  "Voice Mail access"^{*3}

Operation	Code	
Listening to voice mail messages.	#330	58

Main menu:  "Intercom"

Operation	Code	
Paging the desired unit.	#274	26

Main menu:  "Key detector"^{*4}

Sub-menu 1	Sub-menu 2	Settings	Code	
Search	–	–	#655	–
Battery check	–	–		

Main menu:  "Bluetooth"

Sub-menu 1	Sub-menu 2	Settings	Code	
Link to cell - 1: Add new device ^{*5} (for CELL 1) - 2: Add new device ^{*5} (for CELL 2)	Connect ^{*1} / Disconnect ^{*1}	-	#6251 ^{*6}	19
			#6252 ^{*7}	
	Ringer volume - Handset	Off-6 <6>	#6281 ^{*6}	22
			#6282 ^{*7}	
	Ringer volume - Base unit ^{*1}	Off-6 <1>	#*6281 ^{*6}	22
			#*6282 ^{*7}	
	Ringer tone ^{*8}	<Tone 2> ^{*6} <Tone 4> ^{*7}	#6291 ^{*6}	-
			#6292 ^{*7}	
	Select unit to ring ^{*1}	Handset 1-6 <All>	#6271 ^{*6}	18
			#6272 ^{*7}	
	Ring as cell (limited) ^{*1}	<On (with Talking CID)> On (without Talking CID) Off	#6141 ^{*6}	18
			#6142 ^{*7}	
	Text message alert - On/Off ^{*1}	<On (no announce)> On (with name) Off	#6101 ^{*6}	49
			#6102 ^{*7}	
Text message alert - Alert tone ^{*9}	<Tone 1> ^{*6} <Tone 2> ^{*7}	#6101 ^{*6}	50	
		#6102 ^{*7}		
Pair	-	#6241 ^{*6}	17	
		#6242 ^{*7}		
Unpair	-	#6111 ^{*6}	17	
		#6112 ^{*7}		
Music player	Play music	-	#609	48
	Music device	<Cell1> Cell2	#606	
Phonebook transfer	-	-	#618	47

Sub-menu 1	Sub-menu 2	Settings	Code	
Settings	Auto connect* ¹	<1 min> 3 min 5 min 10 min Off	#632	18
	Cell area code* ¹	–	#633	20
	Cell line only mode* ¹	On <Off>	#157	19
	Cell line select	Cellphone 1* ⁵ Cellphone 2* ⁵ <Manual>	#634	20
	Set PIN* ¹	<0000>	#619	20
	International code* ¹	–	#117	47
	Country code* ¹	–	#118	
	Trunk prefix* ¹	–	#119	

Main menu:  "Phonebook"

Operation	Code	
Viewing the phonebook entry.	#280	28

Main menu:  "Settings"

Sub-menu 1	Sub-menu 2	Settings	Code		
Ring adjustments	Ringer volume – Handset* ³	Off-6 <6>	#160	–	
	Ringer volume – Base unit* ^{1, 3}	Off-6 <1>	#*160	–	
	Ringer tone* ^{3, *8, *10} (Handset)	<Tone 1>	#161	–	
	Interrupt tone – Handset* ¹¹	<On> Off	#201	25	
	Interrupt tone – Base unit* ^{1, *11}	<On> Off	#*201		
	Silent mode	On/Off – On – <Off>		#238	40
		Start/End – <11:00 PM/ 06:00 AM>		#237	40
		Select group		#241	40

Programming

Sub-menu 1	Sub-menu 2	Settings	Code	
Set date & time	Date and time ^{*1}	–	#101	15
	Memo alarm – Alarm1-5	Once Daily Weekly <Off>	#720	39
	Time adjustment ^{*1, *12}	<Caller ID auto> Manual	#226	–
Talking caller ID	Handset	<On> Off	#162	44
	Base unit ^{*1}	On <Off>	#*162	
Key detector setting ^{*4} – 1: Add new device (for Detector1) ^{*13} – 2: Add new device (for Detector2) – 3: Add new device (for Detector3) – 4: Add new device (for Detector4)	Change name ^{*1}	Detector1	#6561	–
		Detector2 ^{*14}	#6562 ^{*15}	
		Detector3 ^{*14}	#6563 ^{*15}	
		Detector4 ^{*14}	#6564 ^{*15}	
	Registration	–	#6571	–
			#6572 ^{*15}	
			#6573 ^{*15}	
			#6574 ^{*15}	
	Deregistration	–	#6581	–
			#6582 ^{*15}	
			#6583 ^{*15}	
			#6584 ^{*15}	
Call block ^{*1}	Block a single number	–	#217	40
	Block range of numbers	–		
	Block unknown CID (CID: Caller ID)	On <Off>	#240	41
	First ring	<On> Off	#173	41
Speed dial	–	–	#261	30
Record greeting ^{*1}	–	–	#302	15
Voice mail ^{*3}	Save VM access# ^{*1} (VM: Voice mail)	–	#331	58
	VM tone detect ^{*1}	<On> Off	#332	58

Sub-menu 1	Sub-menu 2	Settings	Code	
Display	Wallpaper	<Wallpaper1>	#181	–
	Clock	<On> Off	#198	–
	Display color	<Color1> Color2	#182	–
	Display mode ^{*16}	<Multi items> Single item	#192	–
	LCD backlight ^{*17}	<On> Off	#191	–
	Handset name	–	#104	42
	Display name	On <Off>	#105	42
Smart function key	–	–	#278	16
Key tone	–	<On> Off	#165	–
Caller ID edit (Caller ID number auto edit)	–	<On> Off	#214	45
Auto talk ^{*18}	–	On <Off>	#200	22
Set tel line ^{*3}	Set dial mode ^{*1}	Pulse <Tone>	#120	16
	Set flash time ^{*1, *19}	900 ms <700 ms> 600 ms 400 ms 300 ms 250 ms 200 ms 160 ms 110 ms 100 ms 90 ms 80 ms	#121	23
	Set line mode ^{*1, *20}	A 	#122	–
Call sharing ^{*1}	–	<On> Off	#194	24
Registration	Register handset	–	#130	42
	Deregistration ^{*2}	–	#131	42
Customer support	–	–	#680	–

Programming

Sub-menu 1	Sub-menu 2	Settings	Code	
Change language	Display	<English> Español	#110	15
	Voice prompt*1	<English> Español	#112	15

Main menu:  "Play music"

Operation	
Playing music from a Bluetooth device.	48

Main menu:  "Set date & time"*21

Sub-menu 1	Sub-menu 2	Settings	Code	
Date and time*1	–	–	#101	15
Memo alarm	Alarm1-5	Once Daily Weekly <Off>	#720	39
Time adjustment*1, *12	–	<Caller ID auto> Manual	#226	–

- *1 If you program these settings using one of the units, you do not need to program the same item using another unit.
- *2 This menu is not displayed when scrolling through the display menus. It is only available in direct command code.
- *3 When the cellular line only mode is turned on, these menus are not displayed (page 19).
- *4 This setting is available when you have the key detector (KX-TGA20). Read the installation manual for more information on the key detector.
- *5 After the Bluetooth device is paired, the device name is displayed.
- *6 For CELL 1
- *7 For CELL 2
- *8 The preset melodies in this product ("Tone 3" - "Melody 15") are used with permission of © 2012 Copyrights Vision Inc.
- *9 The preset melodies in this product are used with the following permission:
– "Tone 1" and "Tone 2": © 2013 Copyrights Vision Inc.
– "Tone 5" – "Melody 15": © 2012 Copyrights Vision Inc.
- *10 If you subscribe to a distinctive ring service (such as IDENTA-RING), select a tone (tone 1 or 2). If you select a melody, you cannot distinguish lines by their ringers.
- *11 This tone lets you know when you receive an outside call while you are on another line or an intercom call. If you select "On", the tone sounds 2 times.
- *12 This feature allows the unit to automatically adjust the date and time each time caller information including date and time is received.
To turn this feature on, select "Caller ID auto". To turn this feature off, select "Manual". (Caller ID subscribers only)
To use this feature, set the date and time first (page 15).
- *13 For models with supplied key detectors, the display shows "1: Detector1".
- *14 If you register 2 or more key detectors.

- *15 If you have 2 or more key detectors.
- *16 You can select to display either a single item or multiple items on one screen at a time for the handset menu list, recorded message list, phonebook list, caller list, and redial list. When in multiple items display mode, you can switch the screen to confirm the detailed information by:
- pressing **[DETAIL]**, or
 - pressing **[MENU]** → **[↕]**: “Detail” → **[SELECT]**
- *17 You can set the handset display backlight while on charge.
- “On”: Backlight is on (dimmed).
 - “Off”: Backlight turns off after 10 seconds of charging. Additionally, less power is consumed if you leave the handset on the base unit or charger after the battery is fully charged.
- *18 If you subscribe to a Caller ID service and want to view the caller’s information after lifting up the handset to answer a call, turn off this feature.
- *19 The flash time depends on your telephone exchange or host PBX. Contact your PBX supplier if necessary. The setting should stay at “700 ms” unless pressing **[FLASH]** fails to pick up the waiting call.
- *20 Generally, the line mode setting should not be changed. This setting automatically maintains receiver volume at the proper level depending on the current telephone line condition. Set the line mode to “A” if telephone line condition is not good.
- *21 This menu icon is displayed when the key detector is not registered.

Alarm

An alarm sounds at the set time for 1 minute and is repeated 5 times at 5 minute intervals (snooze function). A text memo can also be displayed for the alarm. A total of 5 separate alarm times can be programmed for each handset. You can set one of 3 different alarm options (once, daily, or weekly) for each alarm time.

Important:

- Make sure the unit’s date and time setting is correct (page 15).

- 1 **[MENU]** (right soft key) **[#][7][2][0]**
- 2 Select an alarm by pressing **[1]** to **[5]**. → **[SELECT]**
- 3 **[↕]**: Select the desired alarm option. → **[SELECT]**

“Off”

Turns alarm off. Go to step 10.

“Once”

An alarm sounds once at the set time.

“Daily”

An alarm sounds daily at the set time.
Go to step 5.

“Weekly”

Alarm sounds weekly at the set time(s).

- 4 Proceed with the operation according to your selection in step 3.
 - **Once:**
Enter the desired month and date. → **[OK]**
 - **Weekly:**
[↕]: Select the desired day of the week and press **[SELECT]**. → **[OK]**
- 5 Set the desired time.
- 6 **[*]**: Select “AM” or “PM”. → **[OK]**
- 7 Enter a text memo (30 characters max.). → **[OK]**
- 8 **[↕]**: Select the desired alarm tone. → **[SELECT]**
 - We recommend selecting a different ringer tone from the one used for outside calls.

- 9 **[↕]**: Select the desired snooze setting.
→ **[SAVE]**

10 **[SELECT]** → **[OFF]**

Note:

- Press **[STOP]** to stop the alarm completely.
- When the handset is in use, the alarm will not sound until the handset is in standby mode.
- Press any dial key, **[NR]**, or **[SNOOZE]** to stop the sound but keep the snooze function activated.
- If you want to make an outside call when the snooze function is activated, please stop the snooze function before making the call.

Silent mode

Silent mode allows you to select a period of time during which the handset will not ring for outside calls. This feature is useful for time periods when you do not want to be disturbed, for example, while sleeping. Silent mode can be set for each unit.

Using the phonebook's group feature (page 28), you can also select groups of callers whose calls override silent mode and ring the handset (Caller ID subscribers only).

Important:

- Make sure the unit's date and time setting is correct (page 15).
- We recommend turning the base unit ringer off (page 34, 35) in addition to turning the silent mode on.
- If you have set the alarm, the alarm sounds even if the silent mode is turned on.

Turning silent mode on/off

- 1 **[MENU]** (right soft key) **#238**
- 2 **[↕]**: Select the desired setting. → **[SAVE]**
 - If you select "OFF", press **[OFF]** to exit.
- 3 Enter the desired hour and minute you wish to start this feature.
- 4 **[☒]**: Select "AM" or "PM". → **[OK]**

- 5 Enter the desired hour and minute you wish to end this feature.
- 6 **[☒]**: Select "AM" or "PM".
- 7 **[SAVE]** → **[OFF]**

Changing the start and end time

- 1 **[MENU]** (right soft key) **#237**
- 2 Continue from step 3, "Turning silent mode on/off", page 40.

Selecting groups to bypass silent mode

- 1 **[MENU]** (right soft key) **#241**
- 2 Select your desired groups by pressing **1** to **9**.
 - "✓" is displayed next to the selected group numbers.
 - To cancel a selected group, press the same dial key again. "✓" disappears.
- 3 **[SAVE]** → **[OFF]**

Call block

This feature rejects calls from unwanted callers (Caller ID subscribers only). The following items are available when storing phone numbers in the call block list (250 max.).

- "Block a single number": The unit can reject calls from specific phone numbers.
- "Block range of numbers": The unit can reject calls that begin with a number stored in the call block list, such as a toll-free phone number prefix or certain area codes.

You can also set the unit to reject calls that do not have a phone number.

When a call is received, the unit rings briefly*1 while caller information is being received. If the caller's phone number matches an entry in the call block list, the unit emits no sound to the caller, and disconnects the call.

*1 This is called first ring. If you do not want the first ring to sound, turn this setting to "OFF" (page 41).

Important:

- Rejected calls are logged in the caller list.

Storing unwanted callers**Storing a single phone number****Important:**

- We recommend storing 10 digits (including the area code). If only 7 digits are stored, all numbers that have the same last 7 digits will be blocked.

■ From the caller list:**When a cellular phone is paired:**

- 1 [v] CID
- 2 [↕]: Select the entry to be blocked. → [MENU]
 - To edit the number: [↕]: "Edit" → [SELECT]
Press [EDIT] repeatedly until the phone number is shown in the 10-digit format. And then, press [x] (Save). Go to step 4.
- 3 [↕]: "Save caller ID" → [SELECT]
- 4 [↕]: "Call block" → [SELECT]
- 5 [↕]: "Yes" → [SELECT]
- 6 Edit the phone number if necessary (24 digits max.).
- 7 [SAVE] → [OFF]

When a cellular phone is not paired:

- 1 [v] CID
- 2 [↕]: Select the entry to be blocked. → [MENU]
 - To edit the number: [↕]: "Edit" → [SELECT]
Press [EDIT] repeatedly until the phone number is shown in the 10-digit format. And then, press [SAVE]. Go to step 4.
- 3 [↕]: "Save caller ID" → [SELECT]
- 4 [↕]: "Call block" → [SELECT]
- 5 [↕]: "Yes" → [SELECT]
- 6 Edit the phone number if necessary (24 digits max.).
- 7 [SAVE] → [OFF]

■ By entering phone numbers:

- 1 [MENU] (right soft key) [#][2][1][7]
- 2 [↕]: "Block a single number" → [SELECT]
- 3 [MENU] → [↕]: "Add" → [SELECT]
- 4 Enter the phone number (24 digits max.).
 - To erase a digit, press [CLEAR].
- 5 [SAVE] → [OFF]

Storing a range of numbers

- 1 [MENU] (right soft key) [#][2][1][7]
- 2 [↕]: "Block range of numbers" → [SELECT]
- 3 [MENU] → [↕]: "Add" → [SELECT]
- 4 Enter the desired number (2-8 digits).
 - To erase a digit, press [CLEAR].
- 5 [SAVE] → [OFF]

Blocking incoming calls that have no phone number

You can reject calls when no phone number is provided, such as private callers or out of area calls.

- 1 [MENU] (right soft key) [#][2][4][0]
- 2 [↕]: Select the desired setting. → [SAVE] → [OFF]

Note:

- When the unit receives a cellular call without a phone number, the call may not be rejected.

Setting the first ring for the call block list

If you do not want the first ring from a number on the call block list to sound, turn the first ring setting to "off". The default setting is "on".

- 1 [MENU] (right soft key) [#][1][7][3]
- 2 [↕]: Select the desired setting. → [SAVE] → [OFF]

Viewing/editing/erasing call block numbers

- 1 **[MENU]** (right soft key) **#217**
- 2 **[↕]**: “Block a single number” or “Block range of numbers” → **[SELECT]**
- 3 **[↕]**: Select the desired entry.
 - To exit, press **[OFF]**.
- 4 **To edit a number:**
[EDIT] → Edit the number. → **[SAVE]**
→ **[OFF]**
To erase a number:
[ERASE] → **[↕]**: “Yes” → **[SELECT]**
→ **[OFF]**

Note:

- When editing, press the desired dial key to add, **[CLEAR]** to erase.

Erasing all call block numbers

- 1 **[MENU]** (right soft key) **#217**
- 2 **[↕]**: “Block a single number” or “Block range of numbers” → **[SELECT]**
- 3 **[MENU]** → **[↕]**: “Erase all” → **[SELECT]**
- 4 **[↕]**: “Yes” → **[SELECT]**
- 5 **[↕]**: “Yes” → **[SELECT]** → **[OFF]**

Other programming

Changing the handset name

The default handset name is “Handset 1” to “Handset 6”. You can customize the name of each handset (“Bob”, “Kitchen”, etc.). This is useful when you make intercom calls between handsets. To display the handset name in standby mode, turn on the handset name display feature (page 42).

- 1 **[MENU]** (right soft key) **#104**
- 2 Enter the desired name (10 characters max.).

3 **[SAVE]** → **[OFF]**

Displaying the handset name

You can select whether or not the handset name is displayed in standby mode. The default setting is “off”.

- 1 **[MENU]** (right soft key) **#105**
- 2 **[↕]**: Select the desired setting. → **[SAVE]** → **[OFF]**

Registering a unit

Operating additional units

Additional handsets

Up to 6 handsets can be registered to the base unit.

Important:

- See page 4 for information on the available model.

Registering a handset to the base unit

The supplied handset and base unit are pre-registered. If for some reason the handset is not registered to the base unit, re-register the handset.

- 1 **Handset:**
[MENU] (right soft key) **#130**
- 2 **Base unit:**
Press and hold **[●]** for about 5 seconds.
 - If all registered handsets start ringing, press **[●]** again to stop, then repeat this step.
- 3 **Handset:**
Press **[OK]**, then wait until a long beep sounds.

Deregistering a handset

A handset can cancel its own registration to the base unit, or other handsets registered to

the same base unit. This allows the handset to end its wireless connection with the system.

- 1** **[MENU]** (right soft key) **#131**
 - All handsets registered to the base unit are displayed.
- 2** **[↕]**: Select the handset you want to cancel. → **[SELECT]**
- 3** **[↕]**: “Yes” → **[SELECT]** → **[OFF]**

Using Caller ID service

Important:

- This unit is Caller ID compatible. To use Caller ID features, you must subscribe to a Caller ID service. Contact your service provider/telephone company for details.

Caller ID features

When an outside call is being received, the caller information is displayed.

Caller information for the last 50 callers is logged in the caller list from the most recent call to the oldest.

- If the unit cannot receive caller information, the following is displayed:
 - “**Out of area**”: The caller dials from an area which does not provide a Caller ID service.
 - “**Private caller**”: The caller requests not to send caller information.
 - “**Long distance**”: The caller makes a long distance call.
- If the unit is connected to a PBX system, caller information may not be properly received. Contact your PBX supplier.

Missed calls

If a call is not answered, the unit treats it as a missed call. The display shows “**Missed call**”.

Note:

- Even when there are unviewed missed calls, “**Missed call**” disappears from the standby display if the following operation is performed by one of the units:
 - A handset is replaced on the base unit or charger.
 - Pressing **[OFF]** on a handset.

Phonebook name display

When caller information is received and it matches a phone number stored in the phonebook, the stored name in the phonebook is displayed and logged in the caller list.

Talking Caller ID

Handset / Base unit

This feature lets you know who is calling without looking at the display.

To use this feature, you must:

- subscribe to a Caller ID service of your service provider/telephone company.
- turn this feature on (page 36).

When caller information is received, the handsets and/or base unit announce the caller's name or phone number received from your service provider/telephone company following every ring.

The unit announces in English only.

- Name pronunciation may vary. This feature may not pronounce all names correctly.
- Caller ID service has a limit of how many characters can be displayed. If the caller's name is too long, the unit may not be able to display or announce the entire name.

Phonebook name announcement

When caller information is received and it matches a phone number stored in the phonebook, the stored name in the phonebook is announced.

Caller list

Important:

- Make sure the unit's date and time setting is correct (page 15).

Viewing the caller list and calling back

■ Using a cellular line

- 1 **[▼]** CID
- 2 Press **[▼]** to search from the most recent call, or **[▲]** to search from the oldest call.
- 3 **[MENU]** → **[↕]**: “Call back (Cell)”
→ **[SELECT]**
 - To exit, press **[OFF]**.
 - The unit starts dialing when:
 - only 1 cellular phone is paired.

- a specific line is set to make cellular calls (page 20).

4 [↕]: Select the desired cellular phone. → [SELECT]

■ Using the landline

1 [v] CID

2 Press [v] to search from the most recent call, or [▲] to search from the oldest call.

3 To call back, press [↩].
To exit, press [OFF].

Note:

- In step 2, to see the detailed information when in multiple display mode: [MENU] → [↕]: “Detail” → [SELECT]
- If the entry has already been viewed or answered, “✓” is displayed.
- G1 or C2 indicates the caller information was received from the cellular line.

Using the Smart function key

When “Missed call” is displayed and the MR indicator flashes slowly, there are missed calls.

Press [MR] in step 1 on “Viewing the caller list and calling back”, page 44.

- “Missed call” must be set to “On” in “Setting the Smart function key”, page 16.
- If the handset is placed on the base unit or charger, you need to lift up the handset to view the caller list after pressing [MR].
- When the unit has new messages, new voice mail messages, and missed calls, the unit can be operated to play the new messages first, play the new voice mail messages next, and then show the missed calls.

Editing a caller’s phone number

You can edit a phone number in the caller list by removing its area code and/or the long distance code “1”.

1 [v] CID

2 [↕]: Select the desired entry. → [MENU]

3 [↕]: “Edit” → [SELECT]

4 Press [EDIT] repeatedly until the phone number is shown in the desired format.

5 Using a cellular line:

To make a cellular call, continue from step 2, “Making cellular calls”, page 21.

Using the landline:



Caller ID number auto edit feature

Once you call back an edited number, the unit which was used to call back remembers the area code and format of the edited number.

The next time someone calls from the same area code, caller information is customized by the unit as follows:

- When the call is being received, the Caller ID number is displayed in the same format as the edited number.
- After the call has ended, the caller’s phone number is displayed in the same format as the edited number, when reviewed from the caller list.

For example, you can use this feature to set the unit to ignore the area code of callers in your area, so that you can call these local numbers using caller information without dialing the area code.

To activate this feature, you must edit an entry in the caller list, then call that number. After that, phone numbers from that caller’s area code are edited automatically.

This feature can be set for each unit (page 37). The default setting is “On”.

Note:

- Phone numbers from the 4 most recently edited area codes are automatically edited.

Erasing selected caller information

1 [v] CID

2 [↕]: Select the desired entry.

3 [ERASE] → [↕]: “Yes” → [SELECT]

4 [OFF]

Erasing all caller information

- 1 [▼] CID
- 2 [ERASE] → [↕]: "Yes" → [SELECT]
- 3 [OFF]

Copying phonebook from a cellular phone (phonebook transfer)

You can copy phonebook entries from the paired cellular phones or other cellular phones (not paired) to the unit's phonebook. A cellular phone must be compatible with Bluetooth wireless technology.

Important:

- Your cellular phone must support Phone Book Access Profile (PBAP) or Object Push Profile (OPP) specification.
- The unit can copy up to 3 phone numbers of a copied entry for each entry. If an entry has 4 or more phone numbers, the phone numbers will be copied as 2 entries with the same name (up to 6 numbers in total).
- If a phonebook entry includes additional data such as a picture, that entry may fail to copy to the base unit.
- If your cellular phone includes international call entries, set the conversion codes before copying (page 47).

1 Handset:

[MENU] (right soft key) **#618**

2 Handset:

To copy from paired cellular phones:

[↕]: Select the desired cellular phone. → **[SELECT]**

- Copied items are stored to the group ("Cell 1" or "Cell 2") which the cellular phone is paired to.

To copy from other cellular phones (not paired):

[↕]: "Other cell" → **[SELECT]** →

[↕]: Select the group you want to copy to. → **[SELECT]**

3 When "Use the cell to transfer phone book" is displayed: Go to step 4.

When "Select mode" menu is displayed:

[↕]: Select "Auto" or "Manual". →

[SELECT]

"Auto": Download all entries from the cellular phone automatically. Go to step 5.

"Manual": Copy entries you selected.

- "Select mode" menu is displayed only when the cellular phone supports PBAP (Phone Book Access Profile) for Bluetooth connection.
- Some cellular phones may require you to perform an operation on the cellular phone even if you select "Auto".

4 Cellular phone:

Follow the instructions of your cellular phone to copy phonebook entries.

- For other cellular phones (not paired), you need to search for and select the base unit. The Bluetooth PIN (default: "0000") may be required. If your cellular phone shows PassKey confirmation on its display, follow the directions to proceed.
- The entries being copied are displayed on the handset.

5 Handset:

Wait until "Completed" is displayed.

- You can continue copying other entries if necessary.

6 Handset: [OFF]

Note:

- Some copied entries may have characters which do not exist in the character table (page 28). These characters can be displayed but cannot be entered when editing an entry.
- The unit does not support some characters. If a copied entry includes those characters, they are replaced with other available characters or "*".
- If you receive a call while copying phonebook entries, the copying procedure stops. Try again after finishing the call.

Setting conversion codes

You must first set the following 3 dialing codes before transferring the phonebook from your cellular phone (each 4 digits max.).

- "International code": An international prefix used when you make an international call.
- "Country code": Your country code for international calls.

Using Bluetooth Devices

- “**Trunk prefix**”: A trunk prefix; the initial digit(s) to be dialed in a domestic call, prior to the area code.

- 1 [MENU]** (right soft key)
- 2** To store “**International code**”:
1 1 7
To store “**Country code**”: # 1 1 8
To store “**Trunk prefix**”: # 1 1 9
- 3** Enter the desired number. → **[SAVE]**
- 4 [OFF]**

Note:

- After you copy the entries, confirm that the numbers were transferred correctly.

Playing music from a Bluetooth device

This feature allows you to:

- use a Bluetooth device to play music through the base unit’s speaker.
- use the handset as a remote control when playing music from a Bluetooth device through the base unit’s speaker.

Important:

- This feature is compatible with Bluetooth devices that support the Advanced Audio Distribution Profile (A2DP) specification, including iPhone and Android™ devices.
- Your Bluetooth device must support the Audio Video Remote Control Profile (AVRCP ver 1.3 or later) specification to allow the handset to display music information.
- You must select a Bluetooth device to be used with this feature beforehand (page 48).

Selecting a Bluetooth device to be used for playing music

You can select 1 Bluetooth device to be used to play music through the base unit’s speaker.

Important:

- Your Bluetooth device must support music playback. For more details and a list of

compatible devices, please visit the following web site.

<http://www.panasonic.com/link2cell>

- If there is only 1 Bluetooth device paired to the base unit, that Bluetooth device is automatically set to be used for playing music.

- 1 [MENU]** (right soft key) # 6 0 6
- 2 [↕]**: Select the desired Bluetooth device.
→ **[SAVE]** → **[OFF]**

Playing music through the base unit’s speaker

1 Bluetooth device:

Use your Bluetooth device’s media player app to play music.

- The music is played through the base unit’s speaker.
-  is displayed on the handset.

2 Base unit:

Adjust the speaker volume by pressing **[+]** or **[-]**.

Note:

- If the unit is not selected as your Bluetooth device’s audio output device, change the setting.
- Refer to the instructions provided with your Bluetooth device as needed.
- If the base unit and Bluetooth device are not connected, you cannot play music through the base unit’s speaker. Operate the Bluetooth device or press **[*]** on the base unit and wait for a few seconds for the base unit and Bluetooth device to connect, then repeat from step 1.
- While using the handset as a remote control, information such as the song title is displayed on the handset. Unsupported characters are displayed as *****. Depending on the audio file and media app, this information may not be displayed. If the information is too long to be displayed by the handset, the handset may not be able to display all of the information.
- When you are finished listening to music, use your Bluetooth device to stop playback.
- Depending on the media player app, music may not be heard through your Bluetooth

device and the base unit's speaker, but the CELL indicator on the base unit may flash.

Using the handset as a remote control

Important:

- Only 1 handset can be used as a remote control at a time.
 - Confirm in advance that your Bluetooth device's media player app is running.
- 1 **[MENU]** (right soft key) →  → **[SELECT]**
 - The music is played through the base unit's speaker.
 - 2 Perform the following operations as desired.

Key	Operation
[▲] or [▼]	Adjust the base unit's speaker volume
[PAUSE]	Pause playback
[PLAY]	Resume playback
[◀]	Replay the current or previous track
[▶]	Skip to the next track
[◀] (press and hold)	Rewind
[▶] (press and hold)	Fast-forward
[STOP]	Stop playback
[OFF]	Exit remote control mode

Note:

- For details about Bluetooth device operations, refer to the instructions provided with your Bluetooth device as needed.
- When you are finished playing music, use your Bluetooth device to select the appropriate audio output device.
- If you do not hear music through the base unit's speaker, make sure the media player app on your Bluetooth device is running.
- The handset may not be able to control some media player apps.

- When you use the handset as a remote control, the base unit volume cannot be adjusted by pressing the base unit's volume buttons.

Text message (SMS) alert

The handset can notify you when a cellular phone that is paired to the base unit receives a text message. The handset can notify you by briefly displaying a message, by sounding a ringer tone or melody, and by announcement. The announcement is in English only.

Important:

- To use the text message alert feature, you need to pair your cellular phone to the base unit (page 17).
- Your cellular phone must support Message Access Profile (MAP) specification. We recommend that you confirm if your cellular phone supports MAP in advance.
- For more details and a list of compatible devices, please visit the following web site.
<http://www.panasonic.com/link2cell>

For those whose devices do not support the Message Access Profile (MAP):

By installing the app "Text Message Alert", you can use the text message alert feature. Please visit our Web site:

<http://www.panasonic.net/pcc/support/tel/sms/>



- Refer to your cellular phone operating instructions for information on how to install applications.

Setting text message (SMS) alert

The following settings are available. The default is "On (no announcement)".

- "On (no announcement)": The handset notifies you but does not make an announcement.

Using Bluetooth Devices

- “On (with name)”: The handset notifies you and announces the name of the message sender.
- “Off”: The handset does not notify you.

Your cellular phone

In order to use the text message alert feature, you may need to enable your cellular phone's Bluetooth notification feature.

Handset

■ Turning text message (SMS) alert on/off

- 1 For CELL 1: **[MENU]** (right soft key)
[6] [1] [0] [1]
For CELL 2: **[MENU]** (right soft key)
[6] [1] [0] [2]
- 2 **[↕]**: “On/Off” → **[SELECT]**
- 3 **[↕]**: Select the desired setting.
- 4 **[SAVE]** → **[OFF]**

■ Selecting the alerting tone

- 1 For CELL 1: **[MENU]** (right soft key)
[6] [1] [0] [1]
For CELL 2: **[MENU]** (right soft key)
[6] [1] [0] [2]
- 2 **[↕]**: “Alert tone” → **[SELECT]**
- 3 **[↕]**: Select the desired setting.
- 4 **[SAVE]** → **[OFF]**

Note:

- If the text message alert feature does not work, you must turn on notifications in the Bluetooth settings of your cellular phone. Then, unplug the base unit's AC adaptor and reconnect it to activate the text message alert feature. For instructions on how to do this, visit our Web site:
<http://www.panasonic.net/pcc/support/tel/sms/>
- The unit announces the name or phone number depending on your cellular phone.
- This feature may not pronounce all names correctly.
- Text message alerts are not logged in the caller list of your unit.

Answering system for landline

The answering system can answer and record calls for you when you are unavailable to answer the phone.

You can also set the unit to play a greeting message but not to record caller messages by selecting “**Greeting only**” as the recording time setting (page 56).

Important:

- Make sure the unit's date and time setting is correct (page 15).

Memory capacity (including your greeting message)

The total recording capacity is about 18 minutes. A maximum of 64 messages can be recorded.

Note:



- When message memory is full:
 - “**Messages full**” is shown briefly on the handset display.
 - The  indicator on the base unit flashes quickly. (If there are new messages recorded, the indicator flashes slowly until you have listened to the new messages.)
 - If you use the pre-recorded greeting message, the unit automatically switches to another pre-recorded greeting message asking callers to call again later.
 - If you recorded your own greeting message, the same message is still announced to callers even though their messages are not recorded.

Turning the answering system on/off

- 1 To turn on:
[MENU] (right soft key) **#327**
 To turn off:
[MENU] (right soft key) **#328**

2 [OFF]

Note:

- When the answering system is turned on,
 -  is displayed on the handset.
 -  indicator on the base unit lights up.

Greeting message

When the unit answers a call, a greeting message is played to callers.

You can use either:

- your own greeting message
- a pre-recorded greeting message

Recording your greeting message

- 1 **[MENU]** (right soft key) **#302**
- 2 **[↕]**: “**Yes**” → **[SELECT]**
- 3 After a beep sounds, hold the handset about 20 cm (8 inches) away and speak clearly into the microphone (2 minutes max.).
- 4 Press **[STOP]** to stop recording. → **[OFF]**

Using a pre-recorded greeting message

The unit provides 2 pre-recorded greeting messages:

- If you erase or do not record your own greeting message, the unit plays a pre-recorded greeting asking callers to leave a message.
- If the message recording time (page 56) is set to “**Greeting only**”, callers' messages are not recorded and the unit plays a different pre-recorded greeting message asking callers to call again.

Resetting to a pre-recorded greeting message

If you want to use a pre-recorded greeting message once you record your own greeting message, you need to erase your own greeting message.

1 **[MENU]** (right soft key) **#304**

2 **[YES]** → **[OFF]**

Playing back the greeting message

1 **[MENU]** (right soft key) **#303**

2 To exit, press **[OFF]**.

Listening to messages

When new messages have been recorded:

- “**New message**” is displayed on the handset.
- **00** indicator on the base unit flashes slowly.

1 **To listen to new messages:**

[MENU] (right soft key) **#323**

To listen to all messages:

[MENU] (right soft key) **#324**

2 When finished, press **[OFF]**.

Note:

- To switch to the receiver, press **[↶]**.
- You can also use the **[PLAY]** soft key, if displayed, to play new messages.

Using the Smart function key

When “**New message**” is displayed and the **NR** indicator flashes slowly, there are new messages.

Press **[NR]** in step 1 on “Listening to messages”, page 52.

- “**New message**” must be set to “On” in “Setting the Smart function key”, page 16.

Listening to messages from the message list

You can select the item to play back.

1 **[MENU]** (right soft key) **#329**

2 **[↕]**: Select the desired item from the message list. → **[PLAY]**

- You can erase the selected message as follows:

[MENU] → **[↕]**: “Erase” →

[SELECT] → **[↕]**: “Yes” →

[SELECT]

3 When finished, press **[OFF]**.

Note:

- If the item has already been heard, “✓” is displayed.
- “**Message**” is displayed in the message list if the unit cannot receive caller information.

Operating the answering system

[MENU] (right soft key) → **00** → **[SELECT]**

Key	Operation
[▲] or [▼]	Adjust the receiver/speaker volume (during playback)
[1] or [◀]	Repeat message (during playback)*1
[2] or [▶]	Skip message (during playback)*2
[3]	Enter the “Settings” menu
[4]	Play new messages
[5]	Play all messages
[6]	Play greeting message
[7][6]	Record greeting message
[8]	Turn answering system on
[PAUSE]	Pause message*3
[9] or [STOP]	Stop recording Stop playback
[0]	Turn answering system off
[*][4]*4	Erase currently playing message
[*][5]	Erase all messages
[*][6]	Reset to a pre-recorded greeting message

*1 If pressed within the first 5 seconds of a message, the previous message is played except when playing back from the message list.

*2 When you play a message from the message list, the unit stops message playback and the display goes back to the message list.

- *3 To resume playback:
 [↕]: "Playback" → [SELECT]
- *4 You can also erase as follows:
 [PAUSE] → [↕]: "Erase" →
 [SELECT] → [↕]: "Yes" → [SELECT]

Calling back (Caller ID subscribers only)

■ Using a cellular line:

- 1 Press [PAUSE] during playback.
- 2 [↕]: "Call back (Cell)" → [SELECT]
 - The unit starts dialing when:
 - only 1 cellular phone is paired.
 - a specific line is set to make cellular calls (page 20).
- 3 [↕]: Select the desired cellular phone.
 → [SELECT]

■ Using the landline:

- 1 Press [PAUSE] during playback.
- 2 [↕]: "Call back" → [SELECT]

Editing the number before calling back

- 1 Press [PAUSE] during playback.
- 2 [↕]: "Edit" → [SELECT]
- 3 Press [EDIT] repeatedly until the phone number is shown in the desired format (page 45). → [↩]
 - To call back using a cellular line, continue from step 2, "Making cellular calls", page 21.

Erasing all messages

- 1 [MENU] (right soft key) #325
- 2 [↕]: "Yes" → [SELECT] → [OFF]

Advanced new message alerting features

Audible message alert

This feature allows the base unit to beep to inform you of a new message arrival when

new messages are recorded. The base unit beeps 2 times every minute until you listen to the messages, if the "Base unit beep" setting is turned on. The default setting is "off".

- 1 [MENU] (right soft key) #339
- 2 [↕]: Select the desired setting. → [SAVE] → [OFF]

New message alert by a call

This feature allows you to receive a notification by phone when new messages are recorded. The base unit calls a phone number you specify. You can then operate the answering system remotely to listen to the new message.

To use this feature, you must:

- store a phone number to which the unit makes the call to.
 - turn on the new message alert setting.
- After you answer the new message alert call, you can listen to messages from that call (page 54).

Important:

- A new message alert is stopped 1 minute after the call starts to call. The unit will not retry the call even if the call is not answered.

Storing a phone number to which the unit makes an alert call

■ From the phonebook:

- 1 [MENU] (right soft key) #338
- 2 [↕]: "Notification to" → [SELECT] → [ADD]
- 3 [↕]: "Phonebook" → [SELECT]
- 4 [↕]: Select the desired phonebook entry. → [SELECT]
- 5 [↕]: Select the desired phone number.
 → [SAVE] → [OFF]

■ By entering a phone number:

- 1 [MENU] (right soft key) #338
- 2 [↕]: "Notification to" → [SELECT] → [ADD]
- 3 [↕]: "Manual" → [SELECT]

- 4 Enter the desired name (16 characters max.). → [OK]
- 5 Enter the desired number (24 digits max.). → [OK] → [SELECT] → [OFF]

Turning on/off the new message alert setting

- 1 [MENU] (right soft key) [#][3][3][8]
- 2 [↕]: "On/Off" → [SELECT]
- 3 [↕]: Select the desired setting. → [SAVE] → [OFF]

Editing the set phone number

- 1 [MENU] (right soft key) [#][3][3][8]
- 2 [↕]: "Notification to" → [SELECT]
- 3 [MENU] → [↕]: "Edit" → [SELECT]
- 4 Edit the name if necessary (16 characters max.). → [OK]
- 5 Edit the phone number if necessary (24 digits max.). → [OK] → [SELECT] → [OFF]

Erasing the set phone number

- 1 [MENU] (right soft key) [#][3][3][8]
- 2 [↕]: "Notification to" → [SELECT]
- 3 [MENU] → [↕]: "Erase" → [SELECT]
- 4 [↕]: "Yes" → [SELECT] → [OFF]
 - The new message alert setting is turned off.

Activating/inactivating the remote access code to play messages

If you activate this feature, you must enter the remote access code (page 54) to play the new message from the new message alert call. This is so that unauthorized parties cannot listen to your messages. The default setting is "Inactivate".

- "Inactivate": You can listen to the message by pressing [4] to play new messages (without entering the remote access code).

- "Activate": You must enter your remote access code and then press [4] to play new message.

- 1 [MENU] (right soft key) [#][3][3][8]
- 2 [↕]: "Remote code" → [SELECT]
- 3 [↕]: Select the desired setting. → [SAVE] → [OFF]

Listening to messages

After you answer the new message alert, you can listen to the messages as follows.

■ When the remote access code is set to "Inactivate":

Press [4] to play the new message during the announcement.

■ When the remote access code is set to "Activate":

- 1 Enter the remote access code (page 54) during the announcement.
- 2 Press [4] to play the new message.

Note:

- Within 10 seconds after listening to new messages, you can press [#][9] during the call to turn off the new message alert by a call feature.
- Even if the unit makes a new message alert call, the handset redial list does not show the record.

Remote operation

Using a touch-tone phone, you can call your phone number from outside and access the unit to listen to messages or change answering system settings. The unit's voice guidance prompts you to press certain dial keys to perform different operations.

Remote access code

A 3-digit remote access code must be entered when operating the answering system remotely. This code prevents unauthorized parties from listening to your messages remotely. The default setting is "111".

Important:

- To prevent unauthorized access to this product, we recommend that you regularly change the remote code.

- [MENU]** (right soft key) **#306**
- Enter the desired 3-digit remote access code.
- [SAVE] → [OFF]**

Deactivating remote operation

Press **[X]** in step 2 on "Remote access code", page 54.

- The entered remote access code is deleted.

Using the answering system remotely

- Dial your landline phone number from a touch-tone phone.
- After the greeting message starts, enter your remote access code.
- Follow the voice guidance prompts as necessary or control the unit using remote commands (page 55).
- When finished, hang up.

Voice guidance

■ When the English voice guidance is selected

During remote operation, the unit's voice guidance starts and prompts you to press **[1]** to perform a specific operation, or press **[2]** to listen to more available operations.

■ When the Spanish voice guidance is selected

To start the voice guidance, press **[9]**. The voice guidance announces the available remote commands (page 55).

Note:

- If you do not press any dial keys within 10 seconds after a voice guidance prompt, the unit disconnects your call.

Remote commands

You can press dial keys to access certain answering system functions without waiting for the voice guidance to prompt you.

Key	Operation
[1]	Repeat message (during playback)* ¹
[2]	Skip message (during playback)
[4]	Play new messages
[5]	Play all messages
[9]	Stop playback* ² Start voice guidance* ³
[0]	Turn answering system off
[X][4]	Erase currently playing message
[X][5]	Erase all messages
[X][#]	End remote operation (or hang up)

*¹ If pressed within the first 5 seconds of a message, the previous message is played.

*² For English voice guidance only

*³ For Spanish voice guidance only

Turning on the answering system remotely

- Dial your phone number from a touch-tone phone.
- Let the phone ring 15 times.
 - A long beep is heard.
- Enter your remote access code within 10 seconds after the long beep.
 - The greeting message is played back.
 - You can either hang up, or enter your remote access code again and begin remote operation (page 54).

Answering system settings

Call screening

Handset / Base unit

While a caller is leaving a message, you can listen to the call through the unit's speaker. To adjust the speaker volume, press [▲] or [▼] on the handset, or press [+] or [-] on the base unit repeatedly.

You can answer the call by pressing [📞] on the handset or [📞] on the base unit.

Call screening can be set for each unit. The default setting is "On".

- 1 For handset setting: [MENU]** (right soft key) [#][3][1][0]
For base unit setting: [MENU] (right soft key) [#][*][3][1][0]
- 2 [↕]:** Select the desired setting. →
[SAVE] → [OFF]

Number of rings before the unit answers a call

You can change the number of times the phone rings "Ring count" before the unit answers calls. You can select 2 to 7 rings, or "Toll saver".

The default setting is "4 rings".

"Toll saver": The unit's answering system answers at the end of the 2nd ring when new messages have been recorded, or at the end of the 5th ring when there are no new messages. If you call your phone from outside to listen to new messages (page 55), you know that there are no new messages when the phone rings for the 3rd time. You can then hang up without being charged for the call.

- 1 [MENU]** (right soft key) [#][2][1][1]
- 2 [↕]:** Select the desired setting. →
[SAVE] → [OFF]

For voice mail service subscribers

If you subscribe to a flat-rate service package that includes Caller ID, call waiting, voice mail,

and unlimited local/regional/long distance calls, please note the following:

- To use the voice mail service provided by your service provider/telephone company rather than the unit's answering system, turn off the answering system (page 51).
- To use this unit's answering system rather than the voice mail service provided by your service provider/telephone company, please contact your service provider/telephone company to deactivate your voice mail service.

If your service provider/telephone company cannot do this:

- Set this unit's "Ring count" setting so that this unit's answering system answers calls before the voice mail service of your service provider/telephone company does. It is necessary to check the number of rings required to activate the voice mail service provided by your service provider/telephone company before changing this setting.
- Change the number of rings of the voice mail service so that the answering system can answer the call first. To do so, contact your service provider/telephone company.

Caller's recording time

You can change the maximum message recording time allowed for each caller. The default setting is "3 min".

- 1 [MENU]** (right soft key) [#][3][0][5]
- 2 [↕]:** Select the desired setting. →
[SAVE] → [OFF]

Selecting "Greeting only"

You can select "Greeting only" which sets the unit to announce a greeting message to callers but not record messages.

Select "Greeting only" in step 2 on "Caller's recording time", page 56.

Note:

- When you select "Greeting only":
 - If you do not record your own message, the unit will play the pre-recorded

greeting-only message asking callers to call again later.

- If you use your own message, record the greeting-only message asking callers to call again later (page 51).

Voice mail service for landline

Voice mail is an automatic answering service offered by your service provider/telephone company. After you subscribe to this service, your service provider/telephone company's voice mail system answers calls for you when you are unavailable to answer the phone or when your line is busy. Messages are recorded by your service provider/telephone company, not your telephone. Please contact your service provider/telephone company for details of this service.

Important:

- To use the voice mail service provided by your service provider/telephone company rather than the unit's answering system, turn off the answering system (page 51). For details, see page 56.

Storing the voice mail (VM) access number

In order to listen to your voice mail messages, you must dial your service provider/telephone company's voice mail access number. Once you have stored your voice mail access number, you can dial it automatically (page 58).

- 1 **[MENU]** (right soft key) **#331**
- 2 Enter your access number (24 digits max.). → **[SAVE]** → **[OFF]**

Note:

- When storing your voice mail access number and your mailbox password, press **[▲]** (Pause) to add pauses (page 22) between the access number and the password as necessary. Contact your service provider/telephone company for the required pause time.

Example:

<u>1-222-333-4444</u>	<u>PPPP</u>	<u>8888</u>
VM access number	Pauses	Password

To erase the voice mail access number

- 1 **[MENU]** (right soft key) **#331**
- 2 Press and hold **[CLEAR]** until all digits are erased. → **[SAVE]** → **[OFF]**

Voice mail (VM) tone detection

Your service provider/telephone company sends special signals (sometimes called "voice mail tones" or "stutter tones") to the unit to let you know you have new voice mail messages. If you hear a series of dial tones followed by a continuous dial tone after you press **[↶]**, you have new voice mail messages. Soon after you hang up a call or after the phone stops ringing, your unit checks the phone line to see if new voice mail messages have been recorded.

Turn this feature off when:

- You do not subscribe to voice mail service.
- Your service provider/telephone company does not send voice mail tones.
- Your phone is connected to a PBX.

If you are not sure which setting is required, contact your service provider/telephone company.

Turning VM tone detection on/off

The default setting is "on".

- 1 **[MENU]** (right soft key) **#332**
- 2 **[↕]**: Select the desired setting. → **[SAVE]** → **[OFF]**

Listening to voice mail messages

The unit lets you know that you have new voice mail messages in the following way:

- “Voice mail msg. via phone co.” is displayed if message indication service is available.
- 1 **[MENU]** (right soft key) →  → **[SELECT]**
 - The speakerphone turns on.
 - 2 Follow the pre-recorded instructions.
 - 3 When finished, press **[OFF]**.

Note:

- You can also use the **[ACCESS]** soft key, if displayed, to play new voice mail messages.
- If the handset still indicates there are new messages even after you have listened to all new messages, turn it off by pressing and holding **[#]** until the handset beeps.

Using the Smart function key

When “Voice mail msg. via phone co.” is displayed and the **NR** indicator flashes slowly, there are new voice mail messages.

Press **[NR]** in step 1 on “Listening to voice mail messages”, page 58.

- “New VM” must be set to “On” in “Setting the Smart function key”, page 16.
- If the voice mail (VM) access number is not stored, the **NR** indicator does not flash.
- When the unit has new messages, new voice mail messages, and missed calls, the unit can be operated to play the new messages first, play the new voice mail messages next, and then show the missed calls.

Error messages

Display message	Cause/solution
Ask phone company for VM access #	<ul style="list-style-type: none"> You have not stored the voice mail access number. Store the number (page 58).
Base no power or No link to base. Reconnect main base AC adaptor.	<ul style="list-style-type: none"> The handset has lost communication with the base unit. Move closer to the base unit and try again. Unplug the base unit's AC adaptor to reset the unit. Reconnect the adaptor and try again. The handset's registration may have been canceled. Re-register the handset (page 42).
Busy	<ul style="list-style-type: none"> No cellular phone is paired to the base unit. Pair a cellular phone (page 17). The called unit is in use. Other units are in use and the system is busy. Try again later. The handset you are using is too far from the base unit. Move closer and try again. When you tried to use the handset as a remote control when playing music from a Bluetooth device, another handset user was already performing the same operation.
Check tel line	<ul style="list-style-type: none"> The supplied telephone line cord has not been connected yet or not connected properly. Check the connections (page 10). If you do not connect the telephone line cord and use only cellular lines, set the cellular line only mode (page 19).
Error!!	<ul style="list-style-type: none"> Recording was too short. Try again. Someone is using a cellular line. Try again later. The phonebook copy is incomplete (page 47). The cellular phone is disconnected from the base unit. Make sure that other Bluetooth devices are not connected to the cellular phone, and try again. When you tried to play music using a Bluetooth device, the device was not connected to the base unit.
Failed	<ul style="list-style-type: none"> Although the unit tried to connect to the cellular phone, the connection has been failed. <ul style="list-style-type: none"> Someone is using a cellular line. Try again later. Make sure that the cellular phone is not connected to other Bluetooth devices.
Invalid	<ul style="list-style-type: none"> There is no handset registered to the base unit matching the handset number you entered. The handset is not registered to the base unit. Register the handset (page 42).

Display message	Cause/solution
Requires subscription to Caller ID.	<ul style="list-style-type: none"> You must subscribe to a Caller ID service. Once you receive caller information after subscribing to a Caller ID service, this message will not be displayed.
Use rechargeable battery.	<ul style="list-style-type: none"> A wrong type of battery such as Alkaline or Manganese was inserted. Use only the rechargeable Ni-MH batteries noted on page 3, 7.

Troubleshooting

If you still have difficulties after following the instructions in this section, disconnect the base unit's AC adaptor, then reconnect the base unit's AC adaptor. Remove the batteries from the handset, and then insert the batteries into the handset again.

General use

Problem	Cause/solution
The handset does not turn on even after installing charged batteries.	<ul style="list-style-type: none"> Place the handset on the base unit or charger to turn on the handset.
The unit does not work.	<ul style="list-style-type: none"> Make sure the batteries are installed correctly (page 10). Fully charge the batteries (page 10). Check the connections (page 10). Unplug the base unit's AC adaptor to reset the unit. Reconnect the adaptor and try again. The handset has not been registered to the base unit. Register the handset (page 42).
The handset display is blank or dark.	<ul style="list-style-type: none"> The handset is in screen saver mode (page 16). Activate the handset display again by: <ul style="list-style-type: none"> pressing  when on a call. pressing [OFF] at all other times. "LCD backlight" is set to "Off" while on charge. Change the setting (page 37).

Useful Information



Problem	Cause/solution
I cannot pair a cellular phone to the base unit.	<ul style="list-style-type: none">• Depending on the compatibility of the cellular phone, you may not be able to pair it to the base unit. Confirm that your cellular phone supports the hands-free profile (HFP) specification.• Confirm that the Bluetooth feature of your cellular phone is turned on. You may need to turn this feature on depending on your cellular phone.• The Bluetooth technology on your cellular phone may not be functioning normally. Turn off and on your cellular phone.• If your cellular phone is already connected to another Bluetooth device, turn it off or disconnect it from your cellular phone.• Some cellular phones may require you to enter the Bluetooth PIN to pairing. Confirm that you entered the correct PIN.
I cannot connect a cellular phone to the base unit.	<ul style="list-style-type: none">• Confirm that your cellular phone is turned on.• Confirm that your cellular phone is within base unit range (page 14).• Your cellular phone's Bluetooth feature is turned off. Turn it on.• Depending on the state of the wireless environment, such as the presence of any electrical interference, there may be a delay even if the auto connection feature is turned on. You can connect to the base unit manually (page 19).• The cellular phone has not been paired to the base unit. Pair the cellular phone (page 17).
I cannot hear a dial tone.	<ul style="list-style-type: none">• The base unit's AC adaptor or telephone line cord is not connected. Check the connections.• Disconnect the base unit from the telephone line and connect the line to a known working telephone. If the working telephone operates properly, contact our service personnel to have the unit repaired. If the working telephone does not operate properly, contact your service provider/telephone company.
I cannot use the Smart function key even if the NR indicator is flashing slowly.	<ul style="list-style-type: none">• Another unit is in use. Wait and try again later.
The base unit beeps.	<ul style="list-style-type: none">• New messages have been recorded. Listen to the new messages (page 52).

Menu list

Problem	Cause/solution
The display is in a language I cannot read.	<ul style="list-style-type: none">• Change the display language (page 15).

Problem	Cause/solution
I cannot register a handset to a base unit.	<ul style="list-style-type: none"> The maximum number of handsets (6) is already registered to the base unit. Cancel unused handset registrations from the base unit (page 42).

Battery recharge

Problem	Cause/solution
The handset beeps and/or  flashes.	<ul style="list-style-type: none"> Battery charge is low. Fully charge the batteries (page 10).
I fully charged the batteries, but <ul style="list-style-type: none">  still flashes,  is displayed, or the operating time seems to be shorter. 	<ul style="list-style-type: none"> Clean the battery ends (\oplus, \ominus) and the charge contacts with a dry cloth and charge again. It is time to replace the batteries (page 10).

Making/answering calls, intercom

Problem	Cause/solution
 is displayed.	<ul style="list-style-type: none"> The handset is too far from the base unit. Move closer. The base unit's AC adaptor is not properly connected. Reconnect AC adaptor to the base unit. The handset is not registered to the base unit. Register it (page 42).
Noise is heard while talking, sound cuts in and out.	<ul style="list-style-type: none"> You are using the handset or base unit in an area with high electrical interference. Re-position the base unit and use the handset away from sources of interference. Move closer to the base unit. If you use a DSL/ADSL service, we recommend connecting a DSL/ADSL filter between the base unit and the telephone line jack. Contact your DSL/ADSL provider for details. While you are talking on a cellular call using the link to cell feature, you may hear noise during a cellular call if your smartphone is too close to the base unit. For best performance, we recommend placing your smartphone between 0.6 m to 3 m (2 feet to 10 feet) away from the base unit.
Unexpected sounds from your cellular phone are heard through the unit's speaker.	<ul style="list-style-type: none"> Apps installed on your smartphone may treat in-app sound effects or others sounds as music. In this case, these sounds may be heard through the unit's speaker. Use your smartphone to quit the corresponding app.

Useful Information

Problem	Cause/solution
The handset or base unit does not ring.	<ul style="list-style-type: none">● The ringer volume for landline is turned off. Adjust the ringer volume (page 35).● The ringer volume for cellular line is turned off. Adjust the ringer volume (page 34).● When one handset is selected to ring for cellular calls, other units do not ring. To change the selection, see page 18.● Silent mode is turned on. Turn it off (page 40).
I cannot make local calls with the handset using a cellular line.	<ul style="list-style-type: none">● You need to add your area code when making cellular calls. Store your area code in order to automatically add it to the beginning of the 7-digit phone number when making cellular calls (page 20).
I cannot make or answer cellular calls with the handset. or I cannot answer cellular calls with the base unit.	<ul style="list-style-type: none">● Depending on the cellular phone's compatibility (page 4), you may not be able to make or answer cellular calls even if the cellular phone is connected to the base unit.● Make sure that the CELL indicator lights up and the cellular phone is connected to the base unit (page 19).● If someone is talking on a cellular call, you cannot use the cellular feature. There can be only one active Bluetooth connection at a time.● The cellular phone is being used separately from your system.
I can make and answer cellular calls but cannot hear a sound.	<ul style="list-style-type: none">● The Bluetooth technology on your cellular phone may not be functioning normally. Turn off and on your cellular phone.● Disconnect and reconnect the base unit AC adaptor and try again.
I cannot switch cellular calls from the unit to the cellular phone.	<ul style="list-style-type: none">● Your cellular phone may not support this feature. Refer to the operating instructions of your cellular phone.
I cannot make a call using the landline.	<ul style="list-style-type: none">● The dialing mode may be set incorrectly. Change the setting (page 16).
I cannot make long distance calls.	<ul style="list-style-type: none">● Make sure that you have long distance service.
I pressed [📞] on the base unit but the desired cellular call was not transferred to the base unit.	<ul style="list-style-type: none">● If the landline is in use when [📞] is pressed on the base unit, the base unit picks up the landline.● If 2 cellular phones are in use when [📞] is pressed on the base unit, the base unit picks up the CELL 1 line.
The cellular line is not disconnected even though I ended the call on the handset (or the base unit).	<ul style="list-style-type: none">● This may occur depending on the phone app. Use the cellular phone to disconnect the call.

Caller ID/Talking Caller ID

Problem	Cause/solution
Caller information is not displayed.	<ul style="list-style-type: none"> ● You must subscribe to Caller ID service. Contact your service provider/telephone company for details. ● If your unit is connected to any additional telephone equipment such as a Caller ID box or cordless telephone line jack, plug the unit directly into the wall jack. ● If you use a DSL/ADSL service, we recommend connecting a DSL/ADSL filter between the base unit and the telephone line jack. Contact your DSL/ADSL provider for details. ● The name display service for landline calls may not be available in some areas. Contact your service provider/telephone company for details. ● Other telephone equipment may be interfering with this unit. Disconnect the other equipment and try again.
Caller information is displayed or announced late.	<ul style="list-style-type: none"> ● Depending on your service provider/telephone company, the unit may display or announce the caller's information at the 2nd ring or later. ● Move closer to the base unit.
Caller information is not announced.	<ul style="list-style-type: none"> ● The ringer volume for landline is turned off. Adjust the ringer volume (page 35). ● The ringer volume for cellular line is turned off. Adjust the ringer volume (page 34). ● When one handset is selected to ring for cellular calls, other units do not announce caller information. To change the selection, see page 18. ● The Talking Caller ID feature is turned off. Turn it on (page 36). ● The ring as cell mode is set to "On (without Talking CID)". To change the mode, see page 18. ● The number of rings for the answering system is set to "2 rings" or "Toll saver". Select a different setting (page 56). ● Your unit does not announce caller information while the other devices such as handsets are engaged in a call.
The caller list/incoming phone numbers are not edited automatically.	<ul style="list-style-type: none"> ● The Caller ID number auto edit feature is turned off. Turn it on and try again (page 37). ● You need to call back the edited number to activate Caller ID number auto edit.
I cannot dial the phone number edited in the caller list.	<ul style="list-style-type: none"> ● The phone number you dialed might have been edited incorrectly (for example, the long distance "1" or the area code is missing). Edit the phone number with another pattern (page 45).
Time on the unit has shifted.	<ul style="list-style-type: none"> ● Incorrect time information from incoming Caller ID changes the time. Set the time adjustment to "Manual" (off) (page 36).

Useful Information

Problem	Cause/solution
The 2nd caller's information is not displayed during an outside call.	<ul style="list-style-type: none">● In order to use Caller ID, call waiting, or Call Waiting Caller ID (CWID), you must first contact your service provider/telephone company and subscribe to the desired service. <p>After subscribing, you may need to contact your service provider/telephone company again to activate this specific service, even if you already subscribed to both Caller ID and Call Waiting with Caller ID services (CWID).</p>

Using Bluetooth devices

Problem	Cause/solution
I cannot copy phonebook entries from a cellular phone.	<ul style="list-style-type: none">● Confirm that the cellular phone supports Bluetooth wireless technology.● Confirm that the cellular phone supports the Phone Book Access Profile (PBAP) or Object Push Profile (OPP) specification.● If the cellular phone is already connected to another Bluetooth device, turn it off or disconnect it from the cellular phone.● Someone is using a cellular line. Try again later.● Turn the cellular phone off, then turn it on and try again.● If an entry is already stored in the unit's phonebook, the entry cannot be copied even by selecting another group.
An error tone is heard when I try to program the Bluetooth feature.	<ul style="list-style-type: none">● The Bluetooth feature cannot be accessed immediately after connecting the AC adaptor to the base unit. Wait a few seconds and try again.
Text message alerts are not displayed or announced.	<ul style="list-style-type: none">● Confirm that the cellular phone supports the Message Access Profile (MAP) specification.● If your smartphone does not support Message Access Profile (MAP), download the "Text Message Alert" app (page 49).● Text message (SMS) alert is set to "On (no announce)" or "Off". Set it to "On (with name)".● The Bluetooth device's Bluetooth notifications setting is turned off.● The handset selected to display and/or announce alerts is in use.● The Bluetooth device or its corresponding cellular line is in use.
I cannot play music from my Bluetooth device through the base unit's speaker.	<ul style="list-style-type: none">● Confirm that your Bluetooth device supports the Advanced Audio Distribution Profile (A2DP) specification.● The desired Bluetooth device is not selected. Change the "Music device" setting (page 34).

Problem	Cause/solution
I cannot use the handset as a remote control when playing music from your Bluetooth device through the base unit's speaker.	<ul style="list-style-type: none"> Confirm that the Bluetooth device supports the Audio Video Remote Control Profile (AVRCP) specification.
The handset does not show music information on the display.	<ul style="list-style-type: none"> Confirm that the Bluetooth device supports the Audio Video Remote Control Profile (AVRCP ver 1.3 or later) specification.
I am not talking on a cellular call, but the CELL indicator on the base unit may flash.	<ul style="list-style-type: none"> Confirm that some kind of media player app is not activated on your smartphone.

Answering system

Problem	Cause/solution
The unit does not record new messages.	<ul style="list-style-type: none"> The answering system is turned off. Turn it on (page 51). The answering system does not answer or record calls from cellular lines. The message memory is full. Erase unnecessary messages (page 52). The recording time is set to "Greeting only". Change the setting (page 56). Your service provider/telephone company's voice mail service may be answering your calls before the unit's answering system can answer your calls. Change the unit's number of rings setting (page 56) to a lower value, or contact your service provider/telephone company. The answering system will not answer incoming calls while the other devices such as handsets are engaged in a call.
I cannot operate the answering system remotely.	<ul style="list-style-type: none"> The remote access code is not set. Set the remote access code (page 54). You are entering the wrong remote access code. If you have forgotten your remote access code, enter the remote access code setting to check your current code (page 54). The answering system is turned off. Turn it on (page 55). You cannot operate the answering system when calling a cellular phone paired to the base unit.
The unit does not emit the specified number of rings.	<ul style="list-style-type: none"> If the first ring is turned off, the number of rings decreases by 1 from the specified number of rings.

Bluetooth PIN

Problem	Cause/solution
I cannot remember the PIN.	<ul style="list-style-type: none">• Change the PIN using the following method.<ol style="list-style-type: none">1 [MENU] (right soft key) [#619]2 [*7000]3 Enter the new 4-digit PIN. → [OK]4 Enter the new 4-digit PIN again. → [SAVE] → [OFF]

Voice mail

Problem	Cause/solution
"Voice mail msg. via phone co." is shown on the handset display. How do I remove this message from the display?	<ul style="list-style-type: none">• This notification is displayed when your service provider/telephone company's voice mail service (not the unit's answering system) has recorded a message for you. Typically you can remove this notification from the display by listening to the message. To listen to the message, dial the voice mail number provided by your service provider/telephone company (for most cases, this will be your own phone number), and follow the voice instructions. Depending on your service provider/telephone company, you may need to remove all messages from your voice mailbox to remove the notification. You can also remove this notification by pressing and holding [#] until the unit beeps.

Liquid damage

Problem	Cause/solution
Liquid or other form of moisture has entered the handset/base unit.	<ul style="list-style-type: none">• Disconnect the AC adaptor and telephone line cord from the base unit. Remove the batteries from the handset and leave to dry for at least 3 days. After the handset/base unit are completely dry, reconnect the AC adaptor and telephone line cord. Insert the batteries and charge fully before use. If the unit does not work properly, contact an authorized service center.

Caution:

- To avoid permanent damage, do not use a microwave oven to speed up the drying process.

FCC and other information

This equipment complies with Part 68 of the FCC rules and the requirements adopted by the ACTA. On the bottom of this equipment is a label that contains, among other information, a product identifier in the format US:ACJ-----.

If requested, this number must be provided to the telephone company.

- Registration No.....(found on the bottom of the unit)
- Ringer Equivalence No. (REN).....0.1B

A plug and jack used to connect this equipment to the premises wiring and telephone network must comply with the applicable FCC Part 68 rules and requirements adopted by the ACTA. A compliant telephone cord and modular plug is provided with the product. It is designed to be connected to a compatible modular jack that is also compliant.

The REN is used to determine the number of devices that may be connected to a telephone line. Excessive RENs on a telephone line may result in the devices not ringing in response to an incoming call. In most but not all areas, the sum of RENs should not exceed five (5.0). To be certain of the number of devices that may be connected to a line, as determined by the total RENs, contact the local telephone company. For products approved after July 23, 2001, the REN for the product is part of the product identifier that has the format US:AAAEQ##TXXXX. The digits represented by ## are the REN without a decimal point (e.g., 03 is a REN of 0.3).

If this equipment causes harm to the telephone network, the telephone company will notify you in advance that temporary discontinuance of service may be required. But if advance notice isn't practical, the telephone company will notify the customer as soon as possible. Also, you will be

advised of your right to file a complaint with the FCC if you believe it is necessary.

The telephone company may make changes in its facilities, equipment, operations or procedures that could affect the operation of the equipment. If this happens the telephone company will provide advance notice in order for you to make necessary modifications to maintain uninterrupted service.

If trouble is experienced with this equipment, for repair or warranty information, please contact a Factory Service Center or other Authorized Servicer. If the equipment is causing harm to the telephone network, the telephone company may request that you disconnect the equipment until the problem is resolved.

Connection to party line service is subject to state tariffs. Contact the state public utility commission, public service commission or corporation commission for information.

If your home has specially wired alarm equipment connected to the telephone line, ensure the installation of this equipment does not disable your alarm equipment. If you have questions about what will disable alarm equipment, consult your telephone company or a qualified installer.

This equipment is hearing aid compatible as defined by the FCC in 47 CFR Section 68.316.

When you hold the phone to your ear, noise might be heard in your Hearing Aid. Some Hearing Aids are not adequately shielded from external RF (radio frequency) energy. If noise occurs, use an optional headset accessory or the speakerphone option (if applicable) when using this phone. Consult with your audiologist or Hearing Aid

Useful Information

manufacturer about the availability of Hearing Aids which provide adequate shielding to RF energy commonly emitted by digital devices.

WHEN PROGRAMMING EMERGENCY NUMBERS AND/OR MAKING TEST CALLS TO EMERGENCY NUMBERS:

- 1) Remain on the line and briefly explain to the dispatcher the reason for the call.
- 2) Perform such activities in the off-peak hours, such as early morning or late evenings.

This device complies with Part 15 of the FCC Rules. Operation is subject to the following two conditions:

(1) This device may not cause harmful interference, and (2) this device must accept any interference received, including interference that may cause undesired operation.

Privacy of communications may not be ensured when using this phone.

CAUTION:

Any changes or modifications not expressly approved by the party responsible for compliance could void the user's authority to operate this device.

NOTE:

This equipment has been tested and found to comply with the limits for a Class B digital device, pursuant to Part 15 of the FCC Rules. These limits are designed to provide reasonable protection against harmful interference in a residential installation. This equipment generates, uses, and can radiate radio frequency energy and, if not installed and used in accordance with the instructions, may cause harmful interference to radio communications. However, there is no guarantee that interference will not occur in a particular installation. If this equipment does cause harmful interference to radio or television reception, which can be determined by turning the equipment off and on, the user is

encouraged to try to correct the interference by one or more of the following measures:

- Reorient or relocate the receiving antenna.
- Increase the separation between the equipment and receiver.
- Connect the equipment into an outlet on a circuit different from that to which the receiver is connected.
- Consult the dealer or an experienced radio/TV technician for help.

Some cordless telephones operate at frequencies that may cause interference to nearby TVs and VCRs. To minimize or prevent such interference, the base of the cordless telephone should not be placed near or on top of a TV or VCR. If interference is experienced, move the cordless telephone further away from the TV or VCR. This will often reduce or eliminate interference.

FCC RF Exposure Warning:

- This product complies with FCC radiation exposure limits set forth for an uncontrolled environment.
- To comply with FCC RF exposure requirements, the base unit must be installed and operated 20 cm (8 inches) or more between the product and all person's body.
- This product may not be collocated or operated in conjunction with any other antenna or transmitter.
- For body-worn operation, the handset must be used only with a non-metallic accessory. Use of other accessories may not ensure compliance with FCC RF exposure requirements.

Notice:

- FCC ID can be found inside the battery compartment or on the bottom of the units.

Compliance with TIA-1083 standard:

Telephone handsets identified with this logo have reduced noise and interference when used with T-Coil equipped hearing aids and cochlear implants.



Guía Rápida Española

Conexiones

Unidad base

- 1 Haga pasar el cable de la línea telefónica (A) y el adaptador de corriente (B) por la ranura de la base.
- 2 Conecte el cable de la línea telefónica (A) y el adaptador de corriente (B) a las tomas que se encuentran en la parte inferior de la unidad hasta que escuche un clic.
- 3 Conecte el adaptador de corriente alterna a la toma de corriente.
- 4 Conecte el cable de la línea telefónica a la toma de una sola línea telefónica (RJ11C) hasta que escuche un clic.
- 5 Se requiere un filtro DSL/ADSL (no incluido) si tiene este tipo de servicio.

Nota:

- Use solo el adaptador de corriente alterna Panasonic AC PNLV238 que se incluye.

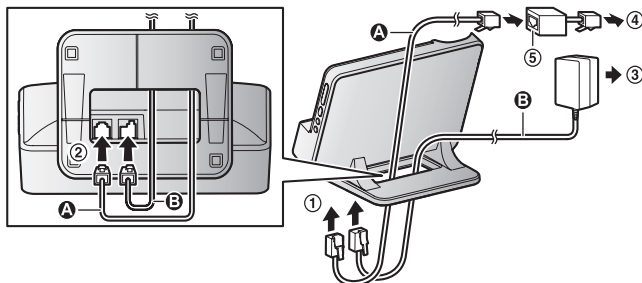

Cargador

- 1 Conecte el adaptador de corriente a la unidad cargadora hasta que escuche un clic.
- 2 Conecte el adaptador de corriente alterna a la toma de corriente.

Nota:

- Use solo el adaptador de corriente alterna Panasonic AC PNLV233 que se incluye.

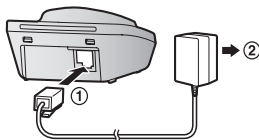

Instalación y carga de la batería

Cargue aproximadamente durante 7 horas.

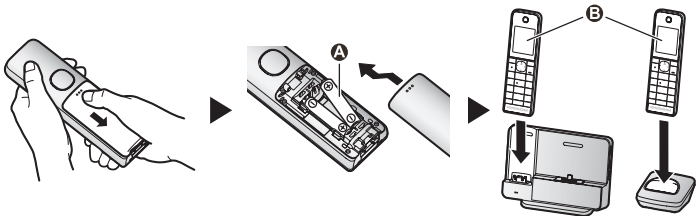

Nota:

- UTILICE SOLO baterías recargables de Ni-MH tamaño AAA (R03) (A).
- NO utilice baterías Alcalinas, de Manganeseo o de Ni-Cd.
- Confirme que las polaridades estén correctas (+, -).
- Cambie el idioma de la pantalla.
- Confirme que aparezca “cargando” (B).

Sugerencias de operación

Teclas de función

Al oprimir una tecla de función, puede seleccionar la función que aparece directamente encima de ella en la pantalla. Preste atención a la pantalla para ver qué funciones están asignadas a las teclas de función durante la operación.

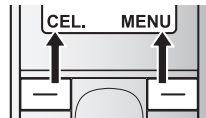

Tecla navegadora

- [▲], [▼], [◀] o [▶]: Navegue por diversas listas y elementos.
- ▲ (Volumen: [▲] o [▼]): Ajuste el volumen del receptor o el altavoz mientras habla.
- [◀] □: Vea la entrada del directorio telefónico.
- [▶] □ REDIAL (Remarcación): Vea la lista de remarcación.
- [▼] CID (Identificador de Llamadas): Vea la lista de personas que llamaron.

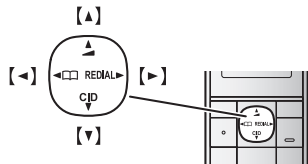

Cambio de idiomas (Auricular) (predeterminado: “English”)

Cuando instale las baterías por primera vez, es posible que aparezca “Date and time Press SELECT”. Oprima [OFF] para salir.

Idioma de la pantalla

[MENU] (tecla de función de la derecha) #1110 → [↓]: “Español” → [GUARDAR] → [OFF]

Idioma de la guía de voz

[MENU] (tecla de función de la derecha) #1112 → [↓]: “Español” → [GUARDAR] → [OFF]

Fecha y hora (Auricular)

- 1 **[MENU]** (tecla de función de la derecha) **#101**
- 2 Introduzca el día, mes y año actuales. → **[OK]**
- 3 Introduzca la hora y minuto actuales (formato de reloj de 24 horas).
- 4 **[GUARDAR]** → **[OFF]**

Cómo grabar el mensaje de saludo del contestador de llamadas para la línea terrestre (Auricular)

Si utiliza un mensaje de saludo pregrabado, no es necesario que grabe su propio mensaje de saludo.

- 1 **[MENU]** (tecla de función de la derecha) **#302** → **[↑]**: "sí" → **[SELEC.]**
- 2 Después de que se emita un pitido, sostenga el auricular a una distancia aproximada de 20 cm (8 pulgadas) y hable con claridad en el micrófono (máx. de 2 minutos).
- 3 Oprima **[PARAR]** para dejar de grabar. → **[OFF]**

Enlace a celular

Puede conectar su unidad base y teléfono celular usando la tecnología inalámbrica Bluetooth®, para poder hacer o responder llamadas a su teléfono celular usando su sistema telefónico. Para obtener más detalles, visite nuestro sitio web: <http://www.panasonic.com/link2cell>

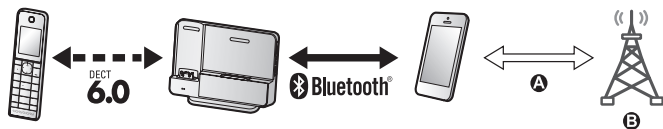

A Línea celular

B Proveedores de servicios de telefonía celular

Marcas registradas

- La marca denominativa y los logotipos de Bluetooth® son marcas registradas de Bluetooth SIG, Inc. y cualquier uso de dichas marcas por parte de Panasonic Corporation se hace bajo licencia.
- Todas las demás marcas comerciales que se identifican en el presente pertenecen a sus respectivos propietarios.

Enlace a celular

Cómo emparejar un teléfono celular con Bluetooth

1 Auricular:

Para CELL 1: **[MENU]** (tecla de función de la derecha) **# 6 2 4 1**

Para CELL 2: **[MENU]** (tecla de función de la derecha) **# 6 2 4 2**

- Después de que el indicador de CELL correspondiente comienza a parpadear en la unidad base, el resto del procedimiento debe completarse en menos de 5 minutos.

2 Su teléfono celular:

Mientras el indicador de CELL correspondiente esté parpadearando, siga las instrucciones de su teléfono celular para entrar al modo de emparejamiento.

- Dependiendo de su teléfono celular, es posible que le pida que introduzca el NIP de la unidad base (predeterminado: "0000"). Si su teléfono celular muestra la confirmación de la PassKey en su pantalla, siga las instrucciones para continuar.

3 Auricular:

Espere a que se emita un pitido largo.

- Es posible que tarde más de 10 segundos en completar el emparejamiento.
- Cuando el indicador de CELL correspondiente se ilumina, esto significa que el teléfono celular está conectado a la unidad base. Ya está listo para hacer llamadas regulares de celular.

4 [OFF]



Nota:

- Asegúrese de que su teléfono celular está configurado para conectarse a este producto automáticamente. Consulte las instrucciones de operación de su teléfono celular.

Unidad base: Indicadores de CELL

Estado	Significado
Encendido	Un teléfono celular está conectado. Listo para hacer o recibir llamadas celulares.
Parpadeando	<ul style="list-style-type: none"> – La línea del celular se está usando. – Las entradas del directorio telefónico se están copiando desde un teléfono celular. – La unidad base está buscando el teléfono celular emparejado. – La unidad base está emparejando un teléfono celular. – Una llamada de celular se pone en espera.
Parpadea rápidamente	Se está recibiendo una llamada de celular.
Luz apagada	<ul style="list-style-type: none"> – No hay un teléfono celular emparejado con la unidad base. – No hay un teléfono celular conectado a la unidad base.

Auricular: enlace a elementos de la pantalla del celular

	<p>Se está usando una línea de celular.</p> <ul style="list-style-type: none"> • Cuando parpadea: la llamada celular se pone en espera. • Cuando parpadea rápidamente: se está recibiendo una llamada celular.
	<p>Un teléfono celular está conectado.*1 Listo para hacer o recibir llamadas celulares.</p> <ul style="list-style-type: none"> • Cuando está apagado: no hay un teléfono celular conectado a la unidad base. <p>*1 La línea o líneas celulares correspondientes se indican enseguida del elemento.</p>
	<ul style="list-style-type: none"> – Se está haciendo una llamada de celular en esa línea. – La línea celular está seleccionada para la configuración.

Enlace a celular

Cómo conectar o desconectar el teléfono celular

Conexión automática a los dispositivos con Bluetooth (teléfonos celulares)

La unidad se conecta a los dispositivos Bluetooth a intervalos regulares si se pierde la conexión. Consulte las instrucciones de operación para cambiar el intervalo (predeterminado: "1 min").

- Cuando está usando una línea celular, la unidad base pierde su conexión con otros dispositivos Bluetooth (teléfono celular). Para restablecer la conexión a los teléfonos celulares automáticamente, deje encendida la conexión automática.

Cómo conectar o desconectar manualmente el teléfono celular

Si no va a utilizar el vínculo del teléfono celular emparejado a la función del celular temporalmente (por ejemplo, si no quiere que la unidad timbre cuando su línea celular reciba una llamada), puede desconectar su teléfono celular de la unidad base. Si desea usarlo de nuevo, reconecte el teléfono celular a la unidad base.

- Aunque haya desconectado un teléfono celular emparejado de la unidad base, si lo coloca dentro del alcance de la unidad base durante el intervalo de conexión automática, es posible que se conecte automáticamente a la unidad base.
- Los teléfonos celulares desconectados no se desemparejan de la unidad base, así que no es necesario emparejarlos de nuevo con ella.

Unidad base:

Para conectar

Oprima **[*]** y espere unos segundos a que el teléfono celular y la unidad base se conecten entre sí.

Auricular:

1 Para conectarlo o desconectarlo:

Para CELL 1: **[MENU]** (tecla de función de la derecha) **[#][6][2][5][1]** (Se emite un pitido largo.)

Para CELL 2: **[MENU]** (tecla de función de la derecha) **[#][6][2][5][2]** (Se emite un pitido largo.)

2 [OFF]

Modo exclusivo para la línea celular (si no utiliza la línea terrestre) (Auricular)

Si no utiliza la línea terrestre, configure el modo exclusivo para la línea celular para usar esta unidad en forma más conveniente.

Si enciende el "Modo Lín. Cel.", desconecte el cable de la línea telefónica de la unidad base. De lo contrario, no es posible activar el "Modo Lín. Cel."

1 **[MENU]** (tecla de función de la derecha) **[#][1][5][7]**

2 Para encenderlo:

[↑]: "Encendido" → **[SELEC.]** → **[↓]**: "sí" → **[SELEC.]**

Para apagarlo:

[↓]: "Apagado" → **[SELEC.]**

Operaciones básicas

Cómo hacer y contestar llamadas (Auricular)

<p>Para hacer llamadas de celular</p>	<p>1 Marque el número telefónico. → [CEL.]</p> <ul style="list-style-type: none"> • Cuando el modo exclusivo para la línea celular está configurado, también puede oprimir [📶]/[📶] en lugar de [CEL.]. • Cuando solo hay 1 teléfono celular emparejado, la unidad comienza a marcar. <p>2 Cuando hay 2 teléfonos celulares emparejados: [📶]: Seleccione el teléfono celular deseado. → [SELEC.]</p>
<p>Para hacer llamadas por la línea terrestre</p>	<p>Marque el número telefónico. → [📶]/[📶]</p>
<p>Para contestar llamadas</p>	<p>[📶]/[📶]/[📶]</p>
<p>Para colgar</p>	<p>[OFF]</p>
<p>Para ajustar el volumen del receptor o del altavoz</p>	<p>Oprima [▲] o [▼] repetidamente mientras habla.</p>
<p>Cómo hacer una llamada usando la lista de remarcación</p>	<p>1 [▶] REDIAL → [📶]: Seleccione la entrada deseada.</p> <p>2 Para hacer una llamada celular: Cuando solo 1 teléfono celular está emparejado: [CEL.] o Cuando 2 teléfonos celulares están emparejados: [CEL.] → [📶]: Seleccione el teléfono celular deseado. → [SELEC.]</p> <p>Para hacer una llamada terrestre: [📶]</p>
<p>Para ajustar el volumen del timbre (línea de celular/línea terrestre)</p>	<p>Oprima [▲] o [▼] repetidamente para seleccionar el volumen deseado mientras timbra.</p>

Operaciones básicas

Directorio telefónico (Auricular)

Para añadir entradas

- 1 [**←**] **☐** → [**MENU**]
- 2 [**↕**]: “Agrega Ent. Nueva” → [**SELEC.**]
- 3 [**↕**]: “(Nombre)” → [**SELEC.**]
- 4 Introduzca el nombre de la persona (máx. 16 caracteres). → [**OK**]
- 5 [**↕**]: Seleccione la ubicación del número telefónico deseado. → [**SELEC.**]
- 6 Introduzca el número telefónico de la persona (máx. 24 dígitos). → [**OK**]
- 7 [**↕**]: Seleccione la etiqueta deseada. → [**SELEC.**]
 • Para almacenar 2 o 3 números telefónicos, repita los pasos 5 a 7.
- 8 [**↕**]: Seleccione la configuración actual del grupo (predeterminado: “Inicio”). → [**SELEC.**]
- 9 [**↕**]: Seleccione el grupo deseado. → [**SELEC.**]
- 10 [**↕**]: “<Guardar>” → [**SELEC.**] → [**OFF**]

Para hacer llamadas

- 1 [**←**] **☐** → [**↕**]: Seleccione la entrada deseada.
- 2 **Para hacer una llamada celular:**
 Cuando solo 1 teléfono celular está emparejado: [**CEL.**] → [**↕**]: Seleccione el número telefónico deseado. → [**LLAMAR**]
 o
 Cuando 2 teléfonos celulares están emparejados:
 [**CEL.**] → [**↕**]: Seleccione el número telefónico deseado. → [**LLAMAR**] → [**↕**]: Seleccione el teléfono celular deseado. → [**SELEC.**]
Para hacer una llamada terrestre:
 [**☎**] → [**↕**]: Seleccione el número telefónico deseado. → [**☎**]

Contestador de llamadas de la línea terrestre (Auricular)

Para escuchar mensajes

- Para escuchar mensajes nuevos:**
 [**MENU**] (tecla de función de la derecha) **#323**
- Para escuchar todos los mensajes:**
 [**MENU**] (tecla de función de la derecha) **#324**

Cómo usar dispositivos Bluetooth

Copiado de entradas del directorio telefónico desde un teléfono celular con Bluetooth (transferencia del directorio telefónico)

Puede copiar entradas del directorio telefónico desde los teléfonos celulares emparejados o desde otros teléfonos celulares (no emparejados) al directorio telefónico de la unidad.

1 Auricular: [MENU] (tecla de función de la derecha) **#618**

2 Auricular:

Para copiar desde teléfonos celulares emparejados:

[↓]: Seleccione el teléfono celular deseado. → **[SELEC.]**

- Los elementos copiados se almacenan en el grupo ("Ce1. 1" o "Ce1. 2") en el que está emparejado el teléfono celular.

Para copiar desde otros teléfonos celulares (no emparejados):

[↓]: "Otro celular" → **[SELEC.]** → **[↓]:** Seleccione el grupo al que desea copiar. → **[SELEC.]**

3 Cuando aparezca "Transf. datos del directorio del celular": Vaya al paso 4.

Cuando aparezca el menú "Selec. modo":

[↓]: Seleccione "Auto" o "Manual". → **[SELEC.]**

"Auto": Descargue todas las entradas del teléfono celular automáticamente. Vaya al paso 5.

"Manual": Copie las entradas que seleccionó.

- El menú "Selec. modo" aparece solo cuando el teléfono celular soporta PBAP (Perfil de Acceso a Directorio Telefónico) para la conexión Bluetooth.

4 Teléfono celular:

Siga las instrucciones de su teléfono celular para copiar las entradas del directorio telefónico.

- Para otros teléfonos celulares (no emparejados), necesita buscar y seleccionar la unidad base. Quizás requiera el NIP de Bluetooth (predeterminado: "0000"). Si su teléfono celular muestra la confirmación de la PassKey en su pantalla, siga las instrucciones para continuar.
- Las entradas que se están copiando aparecen en el auricular.

5 Auricular:

Espere a que aparezca "Completo". → **[OFF]**

Cómo usar dispositivos Bluetooth

Cómo reproducir música en un dispositivo Bluetooth

Esta función le permite:

- utilizar un dispositivo Bluetooth para reproducir música a través del altavoz de la unidad base.
- usar el auricular como un control remoto al reproducir música de un dispositivo Bluetooth a través del altavoz de la unidad base.

Cómo reproducir música a través del altavoz de la unidad base

1 Dispositivo Bluetooth:

Utilice la aplicación reproductora de medios de su dispositivo Bluetooth para reproducir música.

- La música se reproduce a través del altavoz de la unidad base.

2 Unidad base:

Ajuste el volumen del altavoz oprimiendo **[+]** o **[-]**.

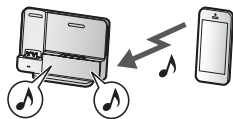

Cómo usar el auricular como control remoto

Importante:

- Confirme de antemano que la aplicación reproductora de medios de su dispositivo con Bluetooth esté funcionando.

1 **[MENU]** (tecla de función de la derecha) → → **[SELEC.]**

- La música se reproduce a través del altavoz de la unidad base.

2 Oprima **[▲]** o **[▼]** para ajustar el volumen del altavoz de la unidad base.

Preguntas frecuentes

Pregunta	Causa y solución
¿Por qué aparece  ?	<ul style="list-style-type: none"> ● El auricular está demasiado lejos de la unidad base. Acérquelo. ● El adaptador para corriente de la unidad base no está conectado correctamente. Conecte de nuevo el adaptador para corriente a la unidad base. ● El auricular no está registrado en la unidad base. Regístrelo. <ol style="list-style-type: none"> 1 Auricular: [MENU] (tecla de función de la derecha) [#] [1] [3] [0] 2 Unidad base: Oprima y mantenga oprimido [**] durante aproximadamente 5 segundos. 3 Auricular: Oprima [OK], y después espere hasta que suene un pitido largo.
¿Por qué no es posible emparejar un teléfono celular con la unidad base?	<ul style="list-style-type: none"> ● Dependiendo de la compatibilidad del teléfono celular, es posible que no pueda emparejarlo con la unidad base. Para obtener más información, visite http://www.panasonic.com/link2cell ● Confirme que la función de Bluetooth de su teléfono celular esté encendida. Es posible que necesite encender esta función dependiendo de su teléfono celular.
¿Cómo se incrementa el nivel de volumen del auricular?	<ul style="list-style-type: none"> ● Oprima la tecla de navegación [▲] repetidamente mientras habla.
¿Por qué hay ruido o se corta la conversación?	<ul style="list-style-type: none"> ● Trate de reubicar la unidad base de forma que se minimice la distancia al auricular. ● Si ocurre el mismo problema aunque el auricular se encuentre enseguida de la unidad base, visite: http://www.panasonic.com/support
¿Es posible añadir otro auricular accesorio a mi unidad base?	<ul style="list-style-type: none"> ● Sí, puede añadir hasta 6 auriculares (incluyendo los que se venden con su unidad base) a una sola unidad base. ● Para adquirir auriculares accesorios adicionales (KX-PRLA20), visite: http://www.pstc.panasonic.com Los usuarios TTY (usuarios con impedimentos auditivos o del habla) pueden llamar al 1-866-605-1277.
¿Es posible mantener cargando las baterías todo el tiempo?	<ul style="list-style-type: none"> ● Puede dejar el auricular en la unidad base o el cargador en cualquier momento. Esto no daña las baterías.
¿Cómo se contestan las llamadas en espera (2ª llamada)?	<ul style="list-style-type: none"> ● Oprima [CALL WAIT] cuando escuche el tono de llamada en espera.

Customer services

Customer Services Directory (United States and Puerto Rico)

Obtain Product Information and Operating Assistance; locate your nearest Dealer or Service Center; purchase Parts and Accessories; or make Customer Service and Literature requests by visiting our Web Site at:

<http://www.panasonic.com/help>

or, contact us via the web at:

<http://www.panasonic.com/contactinfo>

For hearing or speech impaired TTY users, TTY: 1-877-833-8855

Accessory Purchases (United States and Puerto Rico)

Purchase Parts, Accessories and Owner's Manual online for all Panasonic Products by visiting our Web Site at:

<http://www.pstc.panasonic.com>

or, send your request by E-mail to:

npcparts@us.panasonic.com

You may also contact us directly at:

1-800-237-9080 (Fax Only)

(Monday - Friday 9 am to 9 pm, EST.)

Panasonic National Parts Center

20421 84th Avenue S., Kent, WA 98032

(We accept Visa, MasterCard, Discover Card, American Express.)

For hearing or speech impaired TTY users, TTY: 1-866-605-1277

Warranty (For United States and Puerto Rico)

Panasonic Telephone Products Limited Warranty

Limited Warranty Coverage

If your product does not work properly because of a defect in materials or workmanship, Panasonic Corporation of North America (referred to as “the warrantor”) will, for the length of the period indicated on the chart below, which starts with the date of original purchase (“Limited Warranty period”), at its option either (a) repair your product with new or refurbished parts, or (b) replace it with a new or a refurbished equivalent value product, or (c) refund your purchase price. The decision to repair, replace or refund will be made by the warrantor.

Parts
One (1) Year

Labor
One (1) Year

During the “Labor” Limited Warranty period there will be no charge for labor. During the “Parts” Limited Warranty period, there will be no charge for parts. You must mail-in your product prepaid during the Limited Warranty period. This Limited Warranty excludes both parts and labor for batteries, antennas, and cosmetic parts (cabinet). This Limited Warranty only applies to products purchased and serviced in the United States or Puerto Rico. This Limited Warranty is extended only to the original purchaser and only covers products purchased as new.

Mail-In Service--Online

Online Repair Request

To submit a new repair request and for quick repair status visit our Web Site at <http://www.panasonic.com/repair>

When shipping the unit carefully pack in a padded shipping carton, include all accessories, and send it prepaid. Include a letter detailing the complaint, a return address and provide a day time phone number where you can be reached. P.O. Boxes are not acceptable. Keep the tracking number for your records. A copy of valid registered receipt is required under the 1 year parts and labor Limited Warranty.

For Limited Warranty service for headsets if a headset is included with this product please follow instructions above.

IF REPAIR IS NEEDED DURING THE LIMITED WARRANTY PERIOD THE PURCHASER WILL BE REQUIRED TO FURNISH A SALES RECEIPT/PROOF OF PURCHASE INDICATING DATE OF PURCHASE, AMOUNT PAID AND PLACE OF PURCHASE. CUSTOMER WILL BE CHARGED FOR THE REPAIR OF ANY UNIT RECEIVED WITHOUT SUCH PROOF OF PURCHASE.

Limited Warranty Limits And Exclusions

This Limited Warranty ONLY COVERS failures due to defects in materials or workmanship, and DOES NOT COVER normal wear and tear or cosmetic damage. The Limited Warranty ALSO DOES NOT COVER damages which occurred in shipment, or failures which are caused by products not supplied by the warrantor, or failures which result from accidents, misuse, abuse, neglect, bug infestation, mishandling, misapplication, alteration, faulty installation, set-up adjustments, misadjustment of consumer controls, improper maintenance, power line surge, lightning damage, modification, introduction of sand, humidity or liquids, commercial use such as hotel, office, restaurant, or other business or rental use of the product, or service by anyone other than a Factory Service Center or other Authorized Servicer, or damage that is attributable to acts of God.

THERE ARE NO EXPRESS WARRANTIES EXCEPT AS LISTED UNDER "LIMITED WARRANTY COVERAGE". THE WARRANTOR IS NOT LIABLE FOR INCIDENTAL OR CONSEQUENTIAL DAMAGES RESULTING FROM THE USE OF THIS PRODUCT, OR ARISING OUT OF ANY BREACH OF THIS LIMITED WARRANTY. (As examples, this excludes damages for lost time, lost calls or messages, cost of having someone remove or re-install an installed unit if applicable, travel to and from the servicer. The items listed are not exclusive, but are for illustration only.) **ALL EXPRESS AND IMPLIED WARRANTIES, INCLUDING THE WARRANTY OF MERCHANTABILITY, ARE LIMITED TO THE PERIOD OF THE LIMITED WARRANTY.**

Some states do not allow the exclusion or limitation of incidental or consequential damages, or limitations on how long an implied warranty lasts, so the exclusions may not apply to you.

This Limited Warranty gives you specific legal rights and you may also have other rights which vary from state to state. If a problem with this product develops during or after the Limited Warranty period, you may contact your dealer or Service Center. If the problem is not handled to your satisfaction, then write to the warrantor's Consumer Affairs Department at the addresses listed for the warrantor.

PARTS AND SERVICE, WHICH ARE NOT COVERED BY THIS LIMITED WARRANTY, ARE YOUR RESPONSIBILITY.

When you ship the product

- Carefully pack your unit, preferably in the original carton.
- Attach a letter, detailing the symptom.
- Send the unit to Panasonic Exchange Center, prepaid and adequately insured.
- Do not send your unit to Panasonic Corporation of North America listed on the back cover or to executive or regional sales offices. These locations do not repair consumer products.

Index

- # 3-way conference: 24
- A** Additional handset: 42
 - Alarm: 39
 - Answering calls: 22
 - Answering system
 - Call screening: 56
 - Erasing messages: 52, 53, 55
 - Greeting message: 51
 - Greeting only: 56
 - Listening to messages: 52, 55
 - Message list: 52
 - New message alerting: 53
 - Number of rings: 56
 - Recording time: 56
 - Remote access code: 54
 - Remote operation: 54
 - Ring count: 56
 - Toll saver: 56
 - Turning on/off: 51
 - Auto talk: 37
- B** Battery: 10, 11
 - Bluetooth wireless technology
 - Cellular phone (Link to cell): 17
 - Phonebook transfer: 47
 - Booster (Clarity booster): 23
- C** Call block: 40
 - First ring: 41
 - Call share: 24, 37
 - Call waiting: 23
 - Call Waiting Caller ID: 23
 - Caller ID number auto edit: 37, 45
 - Caller ID service: 44
 - Caller list: 44
 - Caller list edit: 45
 - Cellular calls: 21
 - Cellular phone
 - Pairing: 17
 - Unpairing: 17
 - Chain dial: 30
 - CID (Caller ID): 44, 45
 - Conference calls: 24
 - Control type: 12
 - Customer support: 37
- D** Date and time: 15
 - Dialing mode: 16
 - Direct command code: 32
 - Display
 - Color: 37
 - Display mode: 37
 - Language: 15
 - LCD backlight: 37
 - Wallpaper: 37
- E** Eco mode: 11
 - Equalizer: 24
 - Error messages: 60
- F** Flash: 23, 37
- G** Groups: 28
- H** Handset
 - Deregistration: 42
 - Locator: 12, 13
 - Name: 42
 - Registration: 42
 - Hold: 22
- I** Intercom: 26
- K** Key detector: 33, 36
 - Key tone: 37
- L** Landline calls: 21
 - Line mode: 37
 - Link to cell
 - Area code: 20
 - Auto connection: 18
 - Cellular line only mode: 19
 - Cellular line selection: 20
 - Connection: 19
 - Ring as cell mode: 18
 - Select unit to ring: 18
 - Text message (SMS: Short Message Service) alert: 49
- M** Making calls: 21
 - Missed calls: 44
 - Mute: 23
- N** Noise reduction: 23
- P** Pause: 22
 - Phonebook: 27
 - PIN: 20
 - Playing music: 48
 - Power failure: 11
- R** Redialing: 21
 - Ringer ID: 28
 - Ringer tone: 34, 35
 - Rotary/pulse service: 23
- S** Silent mode: 40
 - Smart function key (NR key): 16
 - Speed dial: 30
 - SP-PHONE (Speakerphone): 21
- T** Talking Caller ID: 44
 - Temporary tone dialing: 23
 - Time adjustment: 36

Troubleshooting: 61

TTY: 82

V VM (Voice mail): 58

Voice guidance language: 15

Voice mail: 56, 58

Volume

Receiver: 21

Ringer (Base unit): 22, 34

Ringer (Handset): 22, 34, 35

Speaker: 21

Speaker (Base unit): 22

IMPORTANT!

If your product is not working properly. . .

- ① **Reconnect AC adaptor to the base unit.**
- ② **Check if telephone line cord is connected.**
- ③ **Use rechargeable Ni-MH batteries.**
(Alkaline/Manganese/Ni-Cd batteries CANNOT be used.)
- ④ Read **troubleshooting** page in the **Operating Instructions**.



Visit our Web site: <http://www.panasonic.com/help>

- **FAQ and troubleshooting hints are available.**

For your future reference

We recommend keeping a record of the following information to assist with any repair under warranty.

Serial No. (found on the bottom of the base unit)	Date of purchase
Name and address of dealer	
Attach your purchase receipt here.	

Panasonic Corporation of North America
Two Riverfront Plaza, Newark, NJ 07102-5490

© Panasonic System Networks Co., Ltd. 2013

Printed in Malaysia



PNQX6433YA

PNQX6433YA CC1213WK1014