

Panasonic

ideas for life



Network Color PTZ Dome Camera
WV-NS202



Introducing a network camera so clear,
it exceeds the human eye

NETWORK COLOR PTZ DOME CAMERA
WV-NS202

Preliminary

Exceptional quality, reliable performance, extreme versatility Panasonic's i-Pro WV-NS202 network surveillance camera has arrived.

Panasonic, the leader in video surveillance, introduces a PTZ network camera ahead of its time. Featuring **Super Dynamic III** and progressive output, Panasonic has created unparalleled high-sensitivity and high-resolution image reproduction. The highly reliable WV-NS202 features image backup functions and industrial grade mechanisms while remaining cost effective. Designed for professional surveillance applications, the WV-NS202 PTZ network camera is worthy of the leading role.



Designed to produce High-quality Images

Dealing with a variety of subjects

Pixel Based 128x Dynamic Range

Super Dynamic III performs gradation compensation of contrast on the pixel base, ensuring accurate reproduction of subjects in any situation. It achieves the 128x dynamic range by using images taken at 1/60-second and 1/8,000-second shutter speeds.



Conventional
Depending on subject position, the image may be marred by black spots or halo effects.

Super Dynamic III
Pixel Based 128x Dynamic Range faithfully reproduces every subject.

Capturing remote subjects smoothly

22x Zoom Lens

A 22x optical zoom lens with a focal distance f of 3.79-83.4mm comes standard equipment. Combined with the 10x electronic zoom, 220x magnification is achieved, allowing for high-power surveillance and the capture of subjects at long range.



Easy installation and IP configuration

Power Over Ethernet

With PoE (Power over Ethernet) IEEE802.3af, a separate power supply is not required. Both power and images are transmitted through the same cable. Just connect the cable to a PoE switch or PoE adapter for simple installation.

One-touch Fitting Mechanism

By simply aligning the recessed part of the main unit to the protruding part of the attached mounting bracket and rotating the main unit clockwise, a secure fit is ensured.

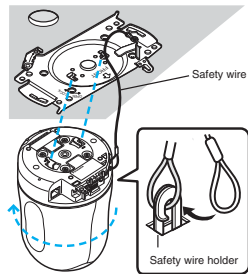

Moving subjects are smooth and easy to see

Progressive Output

Progressive output is utilized for smooth reproduction of moving objects. Compared to interlaced output, images of moving people and passing cars are smooth and easy to see.

Powerful in low light situations

Minimum illumination of 0.7 lux

The WV-NS202 features a minimum illumination of 0.7 lux (0.07 fc). Surveillance is possible in color, even at nighttime. The electronic sensitivity feature (up to 32x) ensures use for night surveillance.



Conventional

WV-NS202

Various settings can be adjusted while monitoring the camera image

Various settings, such as white balance, intensified sensitivity ON/OFF and shutter speeds can be adjusted while monitoring the actual camera image.



Setup panel

Versatile installations for various applications

Various optional fixtures are available, ensuring versatile installation; direct ceiling mount, embedded mount and wall mount. The use of the supplied black cover conceals the direction the camera is facing.



Networking Function

Versatile operation

MPEG-4/JPEG dual streaming

MPEG-4 and JPEG images can be output simultaneously. For example, MPEG-4 for monitoring and high-resolution JPEG for recording. Full-rate transmission of up to 30 fps is possible in either MPEG-4 or JPEG mode. Whether using MPEG-4, JPEG or both, the WV-NS202 allows for versatile operation.

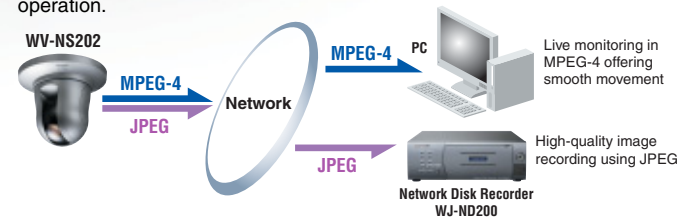

Main Menu



Images can be stored in the camera's on-board SD memory card slot with a single click.

- Up to 16 cameras can be viewed on a multi-screen display, or 4 cameras through a quad display.
- Pan and tilt camera control on a quad-display is possible.
- Full screen mode is available simply by clicking on an image.
- Mouse controls allow for zoom, pan and tilt operations.

FRAME RATE CHART

Image Resolution	Mode	Image Settings									
		0 Super Fine	1 Fine	2	3	4	5 Normal	6	7	8	9 Low
VGA (640 x 480)	Image Size (KB)	128	96	80	64	56	48	40	32	28	24
	Frame Rate (fps)	10	14	17	21	24	30	30	30	30	30
	Bit Rate (Mbps)	10.2	10.8	10.9	10.8	10.8	11.5	9.6	7.7	6.7	5.8
QVGA (320 x 240)	Image Size (KB)	44	40	36	32	28	24	20	16	14	12
	Frame Rate (fps)	26	28	30	30	30	30	30	30	30	30
	Bit Rate (Mbps)	9.2	9.0	8.6	7.7	6.7	5.8	4.8	3.8	3.4	2.9

Highly resistant to network interference

SD memory card slot

In the event of network interference, surveillance images are automatically backed up to an SD memory card. Even during network interruption, surveillance images can be viewed later. Manual recording on the SD memory card is also possible.



Voice exchange

2-way audio feature

Audio monitoring of the peripheral area is made possible by connecting a microphone directly to the camera. Furthermore, the provision of audio output enables voice public-addressing from a PC by connecting an amplifier-integrated loudspeaker. (Voice alternates between transmission and reception.) (ITU-T Standard G.726 Voice Function)

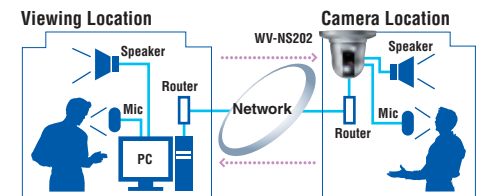

Motion Detection:

When any movement occurs within the camera image, the movement is detected and an alarm signal is transmitted.

FTP server transfer:

JPEG images can be transferred to a pre-designated FTP server.

Alarm mail notification:

E-mails can be transmitted to up to four mail addresses that are registered in advance.

SYSTEM EXAMPLES

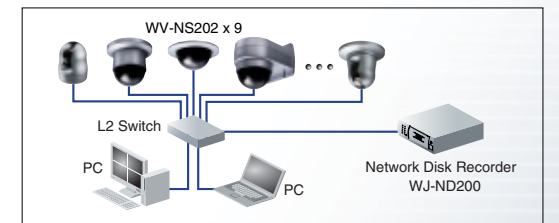

MPEG-4

Image Resolution	Mode	MPEG-4 Bit Rate Settings								
		4,096 kbps	3,072 kbps	2,048 kbps	1,536 kbps	1,024 kbps	512 kbps	256 kbps	128 kbps	64 kbps
VGA (640 x 480)	Low	30	30	30	25	22	10	5	2	1
	Normal	30	30	30	22	14	8	3	1	0.4
	Fine	27	22	19	13	9	4	1.5	0.5	0.2
QVGA (320 x 240)	Low	30	30	30	30	30	28	24	10	4
	Normal	30	30	30	29	28	24	12	4	1.5
	Fine	30	28	28	28	27	12	5	2	0.5

(above all figures are approximate, actual figures may differ depending on the network under the conditions.)

Features and reliability for demanding surveillance applications

Industrial grade mechanism

Heavy duty materials are used for rotating sections. The unit is designed to operate over a long period of time as a result of Panasonic's expertise in manufacturing highly reliable, industrial grade surveillance cameras.



High-speed rotation of 300 degrees/sec.

The camera rotates 350 degrees horizontally at a rotation speed of 300 degrees/sec., max. (when moving between preset positions), enabling the quick capture of subjects. Vertical rotation is also quick at up to 100 degrees/sec.

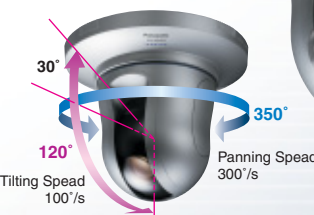

Up to 64 preset positions

Up to 64 camera positions can be registered in advance. The positions can be selected through simple operations.

Auto Tracking

Panning and tilting are automatically executed so that a moving subject can be centered on the screen.

Privacy Zone Masking

When private images exist within an image, masking those portions is possible. Up to eight masks can be applied.

Versatile alarm functions

Alarms from external sensors, VMD camera alarms, and command alarms from other devices can be set in advance.

360-degree map-shot function

When still images of eight locations in a 360 degree arc are displayed as thumbnails and an image is clicked, the camera is directed to that position and displays a live image of the location.

SPECIFICATIONS

Camera	
Image Sensor	1/4 inch interline transfer CCD
Effective Pixels	768 (H) x 494 (V)
Scanning Area	3.59 mm (H) x 2.70 mm (V)
Scanning System	2:1 interlace scan (with motion adaptive interlace/progressive conversion function)
Minimum Illumination	0.7 lx (sensitivity up: OFF, AGC: HIGH) 0.07 lx (sensitivity up: 10x, AGC: HIGH)
Dynamic Range	52 dB typ. (Super dynamic 3: ON, Shutter speed: OFF)
Gain	ON (LOW)/ON (MID)/ON (HIGH)/OFF
Shutter Speed	OFF (1/60), AUTO, 1/100
Sensitivity Up	Up to 32x
White Balance	ATW1/ATW2/AWC
Digital Noise Reduction (DNR)	LOW/HIGH
Electronic Zoom	Up to 10x
Camera Title	Up to 16 characters (alphanumeric characters, marks) ON/OFF
VMD Alarm	ON/OFF, 4 areas available
Image Hold	ON/OFF
Privacy Zone	ON/OFF (up to 8 zones available)
Lens	
Zoom Ratio	22x
Focal Length	3.79 mm ~ 83.4 mm
Maximum Aperture Ratio	1 : 1.6 (WIDE) ~ 3.0 (TELE)
Macro	1.6 m
Aperture Range	F1.6 ~ 22, Close
Horizontal Angle of View	2.6° (TELE) ~ 51.7° (WIDE)
Vertical Angle of View	2.0° (TELE) ~ 39.9° (WIDE)
Panning/tilting platform	
Panning Range	0° ~ 350°
Panning Speed	Manual: Approx. 1°/s ~ 100°/s, preset: up to approx. 300°/s -30° ~ 90° (upward - level - downward)
Tilting Range	Selectable Tilting Angle 0° /-5° /-10° /-15° /-20° /-25° /-30°
Tilting Speed	MANUAL Approx. 1°/s ~ 100°/s, preset: up to approx. 100°/s
Number of The Preset Positions	64
Auto Mode	OFF/preset sequence/auto pan/auto track
Map Shot	360° map shot/preset map shot
Network	
Network	10BASE-T/100BASE-TX, RJ45 connector
Resolution	VGA (640 x 480)/QVGA (320 x 240)
Image Compression Method	MPEG-4 Image quality: LOW/NORMAL/FINE Transmission type: UNICAST/MULTICAST JPEG Image quality: 0 SUPER FINE/1 FINE/2 ~ 5 NORMAL/6 ~ 9 LOW (10 steps: 0 ~ 9) Transmission type: PULL/PUSH
Refresh Interval (MPEG-4)	0.1 fps ~ 30 fps (Frame rate of JPEG display will be limited when displaying JPEG and MPEG-4 simultaneously.)
Audio Compression Method	G.726 (ADPCM) 32 kbps/16 kbps
Bandwidth Control	64 kbps/128 kbps/256 kbps/512 kbps/1,024 kbps/2,048 kbps/4,096 kbps/Unlimited
Protocol	TCP/IP, UDP/IP, HTTP, RTP, FTP, SMTP, DHCP, DNS, DDNS, NTP, SNMP
OS	Microsoft® Windows® 2000 Professional SP4, Microsoft® Windows® XP Home Edition SP2, Microsoft® Windows® XP Professional SP2
Web Browser	Microsoft® Internet Explorer® 6.0 SP2 (Microsoft® Internet Explorer® 6.0 SP1 only when using Windows® 2000 Professional SP4)
Max. Access Number	8 Concurrently (Depends on network conditions)
FTP Client	Alarm image transmission, FTP periodic transmission
Multi-Screen	Images from 16 cameras (4 cameras x 4 groups) can be displayed simultaneously.
SD Memory Card (Option)	Manufactured by Panasonic (Performance with this camera has been checked.) Capacity: 64 MB, 128 MB, 256 MB, 512 MB, 1 GB
General Specifications	
Power Source	DC12 V, PoE (IEEE802.3af compliant)
Power Consumption	DC 12 V Approx. 1,000 mA, PoE: Approx. 12.0 W (Class 0 device)
Ambient Temperature	-10 °C ~ +50 °C (14 °F ~ 122 °F) Recommended operating temperature +35 °C (95 °F)
Ambient Humidity	90 % or less
Monitor Output	VBS 1.0 V [P-P]/75 Ω, composite (BNC), ø3.5 mm mini jack (monaural)
External I/O Terminals	ALARM IN 1, ALARM IN 2/ALARM OUT, ALARM IN 3/AUX OUT (x1 each)
Microphone Input	MIC IN (Applicable microphone: Plug-in power type) Supply voltage: 2.5 V ±0.5 V Input impedance: 3 kΩ ±10 %
Audio Output	AUDIO OUT ø3.5 mm mini jack (monaural) Line level
Dimensions	ø115 mm x 154 mm (H) (ø4-17/32" x 6-1/16" (H)) (excluding the DC 12 V power cord plug)
Weight	Camera: Approx. 850 g (1.87 lbs.) Accessories (Camera mounting bracket, decorative cover): Approx. 200 g (0.44 lbs.)

Trademarks and registered trademarks – Microsoft, and Windows are registered trademarks of Microsoft Corporation in the U.S. and other countries.
– SD logo is a trademark.

Important – Safety Precaution: carefully read the operating instructions and installation manual before using this product.

– Panasonic can not be responsible for network performance and/or other manufacturer products that reside on the network.

• All TV pictures are simulated. • Weights and dimensions are approximate. • Specifications are subject to change without notice. • These products may be subject to export control regulations.

Panasonic

Panasonic System Solutions Company
Unit Company of Panasonic Corporation of North America

Security Systems

Website : www.panasonic.com/security

For Customer Support : call 1.877.733.3689

Executive Office : Three Panasonic Way 2H-2, Secaucus, New Jersey 07094

MAJOR OPERATING CONTROLS & TERMINALS

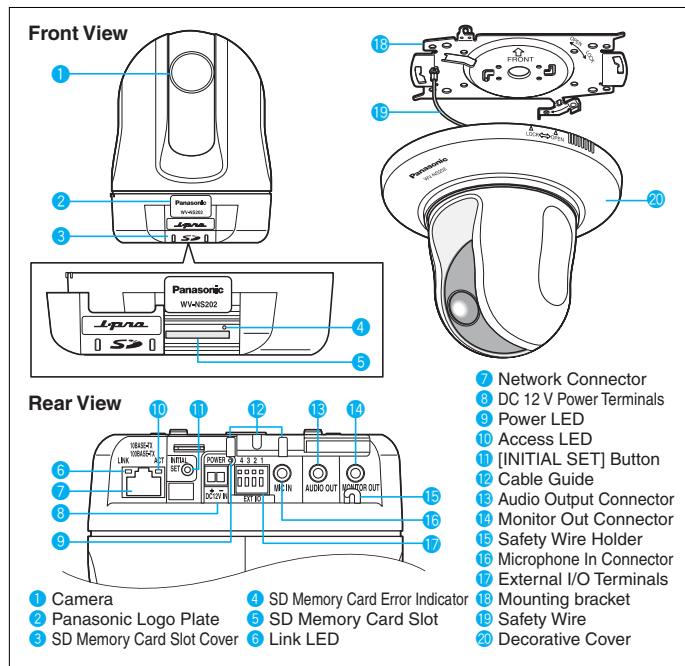

DIMENSIONS

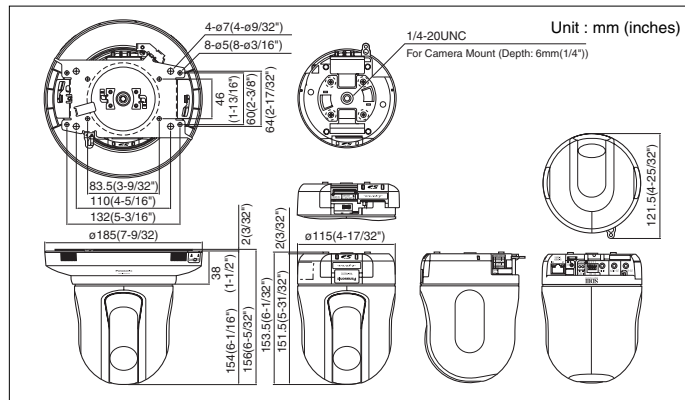

OPTIONAL COMPONENTS & ACCESSORIES



DISTRIBUTED BY:

PANASONIC CANADA INC.

5770 Ambler Drive, Mississauga, Ontario, L4W 2T3 Canada (905) 624-5010

PANASONIC PUERTO RICO INC.

DIVISION OF PANASONIC CORPORATION OF NORTH AMERICA

San Gabriel Industrial Park, 65th Infantry Ave. KM. 9.5 Carolina, P.R. 00985 (809) 750-4300

Printed in Japan

WV-JHNS202C(2P-000)