

Panasonic®

Operating Instructions

Digital Corded/Cordless Answering System

Model No. **KX-TG9471**

KX-TG9472

2LINE



Model shown is KX-TG9471.

Before initial use, see “Getting Started” on page 8.

Thank you for purchasing a Panasonic product.

Please read these operating instructions before using the unit and save them for future reference.

Consulte “Guía Rápida Española”, página 52.

This unit is compatible with Caller ID. You must subscribe to the appropriate service offered by your service provider/telephone company.

For assistance, visit our Web site: <http://www.panasonic.com/help> for customers in the U.S.A. or Puerto Rico.

Please register your product: <http://www.panasonic.com/prodreg>

Table of Contents

Introduction	
Model composition	3
Accessory information	3
System capabilities	5
“Telephone Plug-in” for Microsoft Office Outlook overview	5
Important Information	
For your safety	6
Important safety instructions	7
For best performance	7
Other information	7
Getting Started	
Setting up	8
Note when setting up	10
Controls	11
Belt clip	12
Display/indicators	12
Initial settings	13
Making/Answering Calls	
Making calls	15
Answering calls	16
Useful features during a call	16
Using the other line during a call	18
“Telephone Plug-in” for Microsoft Office Outlook	
“Telephone Plug-in” settings	19
Making a call from “Telephone Plug-in”	20
“Telephone Plug-in” pop-up window for incoming call	22
“Telephone Plug-in” toolbar settings	22
Phonebook	
Base unit/handset phonebook	23
Copying phonebook entries	25
Programming	
Programmable settings	26
Special programming	30
Registering a unit	31
Caller ID Service	
Using Caller ID service	32
Caller list	32
Answering System	
Answering system	35
Turning the answering system on/off	35
Greeting message	35
Listening to messages using the base unit	36
Listening to messages using the handset	37
Remote operation	38
Answering system settings	39
Voice Mail Service	
Voice mail service	41
Intercom/Locator	
Intercom	42
Handset locator	42
Transferring calls	42
Conference calls	43
Useful Information	
Wall mounting	44
Error messages	45
Troubleshooting	46
FCC and other information	50
Guía Rápida Española	
Guía Rápida Española	52
Appendix	
Customer services	58
Warranty (For United States and Puerto Rico)	59
Index	
Index	61

Model composition

Series	Model No.	Base unit	Handset	
		Part No.	Part No.	Quantity
KX-TG9471 series	KX-TG9471	KX-TG9471	KX-TGA939	1
	KX-TG9472	KX-TG9471	KX-TGA939	2

Accessory information

Supplied accessories

No.	Accessory item/Order number	Quantity	
		KX-TG9471	KX-TG9472
①	AC adaptor/PQLV219Y	2	3
②	4-wire telephone line cord with green plugs/PQJA10088Z	1	1
③	2-wire telephone line cord with transparent plugs/PQJA10075Z	1	1
④	Desk stand/Wall mounting adaptor*1/PNKL1034Z1	1	1
⑤	Corded handset/PNLXP1010Z	1	1
⑥	Corded handset cord/PQJA212V	1	1
⑦	Rechargeable batteries/HHR-4DPA	2	4
⑧	Handset cover*2/PNYNTGA939TR	1	2
⑨	Belt clip/PNKE1004Z1	1	2
⑩	Charger/PNLC1001YT	1	2
⑪	mini USB cable/PNJA1081Z	1	1
⑫	CD-ROM/PNJX1009Z	1	1

*1 The desk stand/wall mounting adaptor comes attached to the base unit.

*2 The handset cover comes attached to the handset.

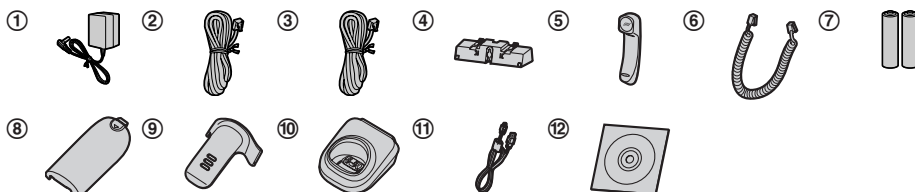

Additional/replacement accessories

Please contact your nearest Panasonic dealer for sales information (page 58).

Accessory item	Order number
Rechargeable batteries	HHR-4DPA*1 ● To order, please call 1-800-332-5368 or visit http://www.panasonic.com/batterystore
	Battery type: – Nickel metal hydride (Ni-MH) – 2 x AAA (R03) size for each handset
Headset	KX-TCA60, KX-TCA93, KX-TCA94, KX-TCA400, KX-TCA430
T-adaptor	KX-J66
2-line splitter	KX-J42

*1 Replacement batteries may have a different capacity from that of the supplied batteries.

Expanding your phone system

Optional handset feature overview

Handset (optional): KX-TGA939	
<p>You can expand your phone system by registering optional handsets (6 max.) to a single base unit.</p> <ul style="list-style-type: none">● Optional handsets may be a different color from that of the supplied handsets.	

System capabilities

The unit can accommodate up to 2 external telephone lines and the following operations are available at the same time.

How many units can be in use at one time?

■ A maximum of 4 parties are available:

Line 1: Outside call (including 1 extension and 1 outside party)

Line 2: Outside call (including 1 extension and 1 outside party)

e.g. Outside call on line 1



e.g. Outside call on line 2



■ A maximum of 5 parties are available:

Line 1: Conference call (including 2 extensions and 1 outside party)

Line 2: Outside call (including 1 extension and 1 outside party)

e.g. Conference call on line 1

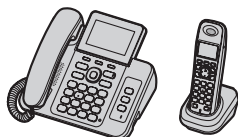

e.g. Outside call on line 2



■ The following operations are possible simultaneously:

- An outside call and 1 pair of intercom call can be made at a time.
- While a caller is leaving a message on your answering system through one line, the unit can make an outside call through another line.

Note:

- The maximum operating number may decrease, depending on the state of usage, for example, when the answering system is taking a call.

“Telephone Plug-in” for Microsoft Office Outlook overview

By installing the supplied “Telephone Plug-in” for Microsoft® Office Outlook® and connecting the base unit and your computer with the mini USB cable, the following features are available:

- You can make a call from the contact list of Microsoft Office Outlook through the base unit speakerphone.
- Caller information is shown in a pop-up window on your computer display when a call is received.

For your safety

To prevent severe injury and loss of life/property, read this section carefully before using the product to ensure proper and safe operation of your product.

WARNING

Power connection

- Use only the power source marked on the product.
- Do not overload power outlets and extension cords. This can result in the risk of fire or electric shock.
- Completely insert the AC adaptor/power plug into the power outlet. Failure to do so may cause electric shock and/or excessive heat resulting in a fire.
- Regularly remove any dust, etc. from the AC adaptor/power plug by pulling it from the power outlet, then wiping with a dry cloth. Accumulated dust may cause an insulation defect from moisture, etc. resulting in a fire.
- Unplug the product from power outlets if it emits smoke, an abnormal smell, or makes an unusual noise. These conditions can cause fire or electric shock. Confirm that smoke has stopped emitting and contact the Panasonic Call Center at 1-800-211-PANA (1-800-211-7262).
- Unplug from power outlets and never touch the inside of the product if its casing has been broken open.
- Never touch the plug with wet hands. Danger of electric shock exists.

Installation

- To prevent the risk of fire or electrical shock, do not expose the product to rain or any type of moisture.
- Do not place or use this product near automatically controlled devices such as automatic doors and fire alarms. Radio waves emitted from this product may cause such devices to malfunction resulting in an accident.
- Do not allow the AC adaptor or telephone line cord to be excessively pulled, bent or placed under heavy objects.

Operating safeguards

- Unplug the product from power outlets before cleaning. Do not use liquid or aerosol cleaners.
- Do not disassemble the product.
- Do not spill liquids (detergents, cleansers, etc.) onto the telephone line cord plug, or allow it to become wet at all. This may cause a fire. If the telephone line cord plug becomes wet, immediately pull it from the telephone wall jack, and do not use.
- Do not excessively pull the corded handset cord from the base unit. This may cause the base unit to fall, resulting in injury.

Medical

- Consult the manufacturer of any personal medical devices, such as pacemakers or hearing aids, to determine if they are adequately shielded from external RF (radio frequency) energy. (The product operates in

the frequency range of 1.92 GHz to 1.93 GHz, and the RF transmission power is 115 mW (max.)

- Do not use the product in health care facilities if any regulations posted in the area instruct you not to do so. Hospitals or health care facilities may be using equipment that could be sensitive to external RF energy.

CAUTION

Installation and location

- Never install telephone wiring during an electrical storm.
- Never install telephone line jacks in wet locations unless the jack is specifically designed for wet locations.
- Never touch uninsulated telephone wires or terminals unless the telephone line has been disconnected at the network interface.
- Use caution when installing or modifying telephone lines.
- The AC adaptor is used as the main disconnect device. Ensure that the AC outlet is installed near the product and is easily accessible.
- This product is unable to make calls when:
 - the handset batteries need recharging or have failed.
 - there is a power failure.

Battery

- We recommend using the batteries noted on page 4. **USE ONLY rechargeable Ni-MH batteries AAA (R03) size.**
- Do not mix old and new batteries.
- Do not open or mutilate the batteries. Released electrolyte from the batteries is corrosive and may cause burns or injury to the eyes or skin. The electrolyte is toxic and may be harmful if swallowed.
- Exercise care when handling the batteries. Do not allow conductive materials such as rings, bracelets, or keys to touch the batteries, otherwise a short circuit may cause the batteries and/or the conductive material to overheat and cause burns.
- Charge the batteries provided with or identified for use with this product only, in accordance with the instructions and limitations specified in this manual.
- Only use a compatible charger to charge the batteries. Do not tamper with the charger. Failure to follow these instructions may cause the batteries to swell or explode.

Attention:



A nickel metal hydride battery that is recyclable powers the product you have purchased. Please call 1-800-8-BATTERY (1-800-822-8837) for information on how to recycle this battery.

Important safety instructions

When using your product, basic safety precautions should always be followed to reduce the risk of fire, electric shock, and injury to persons, including the following:

1. Do not use this product near water for example, near a bathtub, washbowl, kitchen sink, or laundry tub, in a wet basement or near a swimming pool.
2. Avoid using a telephone (other than a cordless type) during an electrical storm. There may be a remote risk of electric shock from lightning.
3. Do not use the telephone to report a gas leak in the vicinity of the leak.
4. Use only the power cord and batteries indicated in this manual. Do not dispose of batteries in a fire. They may explode. Check with local codes for possible special disposal instructions.

SAVE THESE INSTRUCTIONS

For best performance

Base unit location/avoiding noise

The base unit and other compatible Panasonic units use radio waves to communicate with each other.

- For maximum coverage and noise-free communications, place your base unit:
 - at a convenient, high, and central location with no obstructions between the cordless handset and base unit in an indoor environment.
 - away from electronic appliances such as TVs, radios, personal computers, wireless devices, or other phones.
 - facing away from radio frequency transmitters, such as external antennas of mobile phone cell stations. (Avoid putting the base unit on a bay window or near a window.)
- Coverage and voice quality depends on the local environmental conditions.
- If the reception for a base unit location is not satisfactory, move the base unit to another location for better reception.

Environment

- Keep the product away from electrical noise generating devices, such as fluorescent lamps and motors.
- The product should be kept free from excessive smoke, dust, high temperature, and vibration.
- The product should not be exposed to direct sunlight.
- Do not place heavy objects on top of the product.
- When you leave the product unused for a long period of time, unplug the product from the power outlet.
- The product should be kept away from heat sources such as heaters, kitchen stoves, etc. It should not be placed in rooms where the temperature is less than 0 °C (32 °F) or greater than 40 °C (104 °F). Damp basements should also be avoided.
- The maximum calling distance may be shortened when the product is used in the following places: Near obstacles such as hills, tunnels, underground, near metal objects such as wire fences, etc.

- Operating the product near electrical appliances may cause interference. Move away from the electrical appliances.

Routine care

- **Wipe the outer surface of the product with a soft moist cloth.**
- Do not use benzene, thinner, or any abrasive powder.

Other information

CAUTION: Risk of explosion if battery is replaced by an incorrect type. Dispose of used batteries according to the instructions.

Notice on disposal

Disposal may be regulated in your community due to environmental considerations. For disposal or recycling information, please visit Panasonic website: <http://www.panasonic.com/environmental> or call **1-888-769-0149**.

Notice for product disposal, transfer, or return

- This product can store your private/confidential information. To protect your privacy/confidentiality, we recommend that you erase information such as phonebook or caller list entries from the memory before you dispose of, transfer, or return the product.

Notice

- This product is designed for use in the United States of America. Sale or use of this product in other countries may violate local laws.
- Cet appareil est conçu pour être utilisé aux États-Unis d'Amérique. La vente ou l'emploi de cet appareil dans certains autres pays peut constituer une infraction à la législation locale.
- Este producto está diseñado para usarse en los Estados Unidos de América. La venta o el empleo de este producto en ciertos países puede constituir violación de la legislación local.
- 本產品專為美國使用而設。若在其他國家銷售或使用，可能會違反當地法例。
- この製品は、日本国外での使用を目的として設計されており、日本国内での使用は法律違反となります。従って、当社では日本国内においては原則として修理などのサービスは致しかねます。

Setting up

Connecting the AC adaptor/corded handset

- Use only the supplied Panasonic AC adaptor PQLV219.

■ Base unit

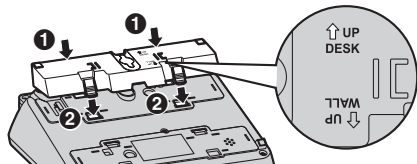
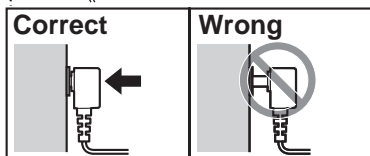
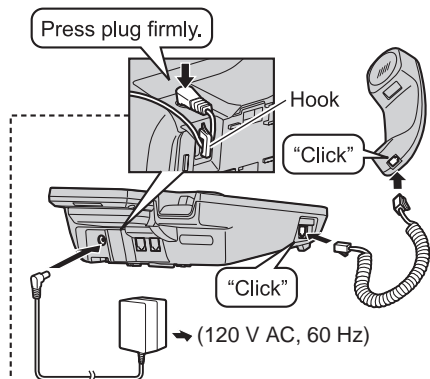
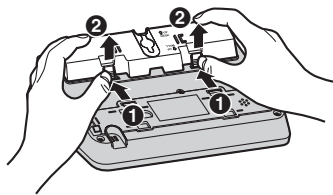

- The words "UP DESK" should be facing up.

■ Charger

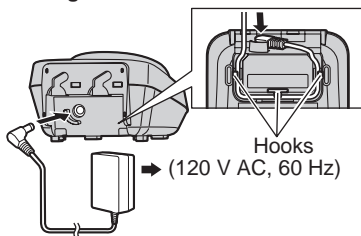

Connecting the telephone line cord

Refer to one of the following methods depending on your situation:

- To connect to a 2-line telephone jack: page 8
- To connect to 2 single-line telephone jacks: page 8
- If you use the unit as a single-line telephone only: page 9

Connect the telephone line cord until it clicks into the base unit and telephone line jack.

To connect to a 2-line telephone jack

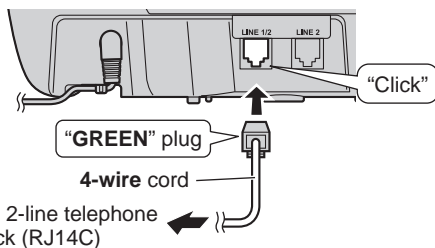

To connect to 2 single-line telephone jacks

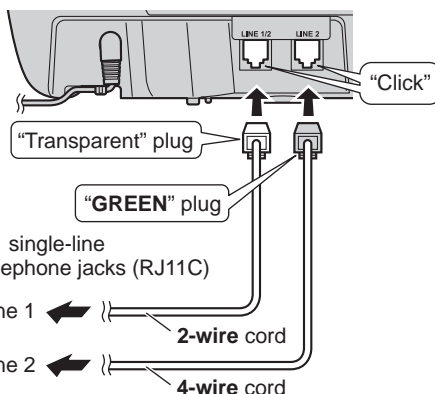

If you use the unit as a single-line telephone only

Be sure to connect the telephone line cord to LINE 1/2. Change the line selection mode from "Auto" to "Line1" (page 14).

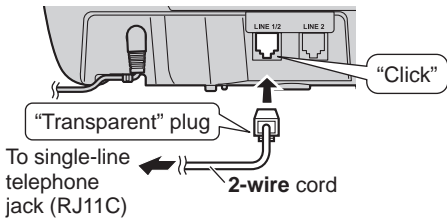

Note:

- "Check tel line 2" is displayed on the unit. To erase it, see page 45.

If you subscribe to a DSL/ADSL service

Please attach a DSL/ADSL filter (contact your DSL/ADSL provider) to the telephone line between the base unit and the telephone line jack in the event of the following:

- noise is heard during conversations.
- Caller ID features do not function properly.

To connect to a 2-line telephone jack

For this connection, please purchase a Panasonic 2-line splitter (page 4).

Example: DSL/ADSL line is line 2

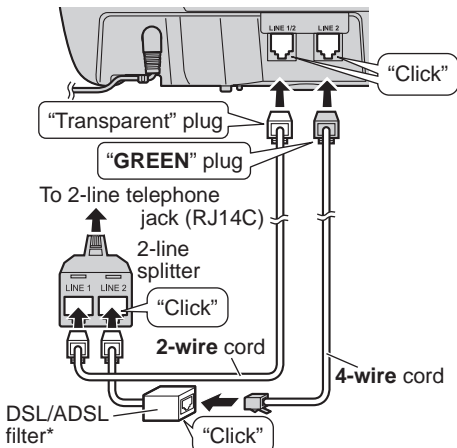

*DSL/ADSL filter (not supplied) is required if you have DSL/ADSL service.

To connect to 2 single-line telephone jacks

Example: DSL/ADSL line is line 2

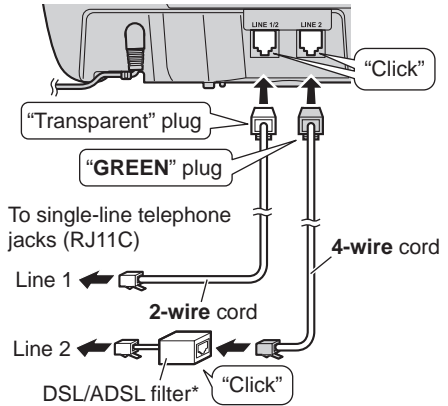

*DSL/ADSL filter (not supplied) is required if you have DSL/ADSL service.

Battery installation

- USE ONLY Ni-MH batteries AAA (R03) size.
- Do NOT use Alkaline/Manganese/Ni-Cd batteries.
- Confirm correct polarities (⊕, ⊖).

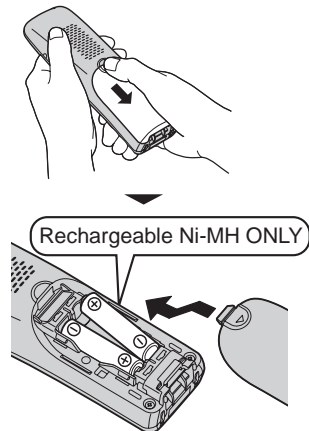

Battery charging

Charge for about 7 hours.

- When the batteries are fully charged, "Charge completed" is displayed.

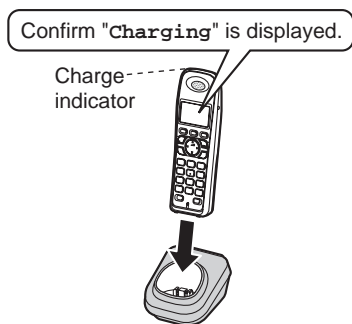

Note when setting up

Note for connections

- The AC adaptor must remain connected at all times. (It is normal for the adaptor to feel warm during use.)
- The AC adaptor should be connected to a vertically oriented or floor-mounted AC outlet. Do not connect the AC adaptor to a ceiling-mounted AC outlet, as the weight of the adaptor may cause it to become disconnected.

During a power failure

The unit will not work during a power failure. We recommend connecting a corded-type telephone (without AC adaptor) to the same telephone line or to the same telephone line jack using a Panasonic T-adaptor (page 4).

Note for battery installation

- Use the supplied rechargeable batteries. For replacement, we recommend using the Panasonic rechargeable batteries noted on page 4, 6.
- Wipe the battery ends (+, -) with a dry cloth.
- Avoid touching the battery ends (+, -) or the unit contacts.

Note for battery charging

- It is normal for the handset to feel warm during charging.
- Clean the charge contacts of the handset and charger with a soft and dry cloth once a month. Clean more often if the unit is exposed to grease, dust, or high humidity.

Battery level

Icon	Battery level
	High
	Medium
	Low
	Needs charging.

Panasonic Ni-MH battery performance (supplied batteries)

Operation	Operating time
In continuous use	12 hours max.
Not in use (standby)	6 days max.

Note:

- Actual battery performance depends on usage and ambient environment.
- Even after the batteries are fully charged, the handset can be left on the charger without any ill effect on the batteries.
- The battery level may not be displayed correctly after you replace the batteries. In this case, place the handset on the charger and let it charge for at least 7 hours.

Controls

Base unit

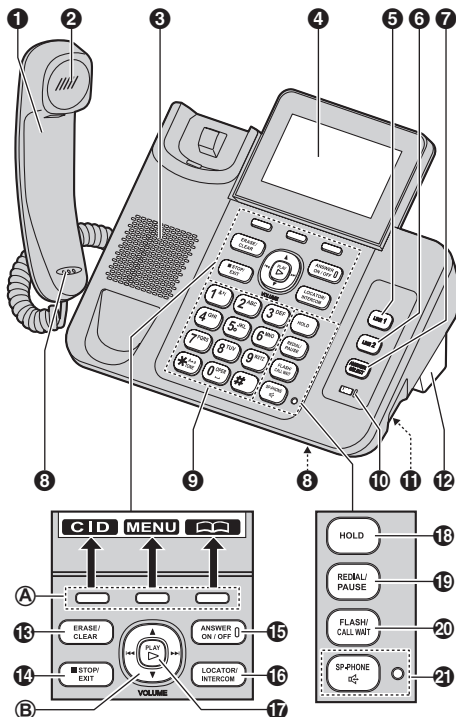

1 Corded handset

2 Receiver

3 Speaker

4 Display

- The display can be moved back and forth to select the desired angle.

5 [LINE 1]

LINE 1 indicator

6 [LINE 2]

LINE 2 indicator

7 [ANSWER SELECT]

8 Microphone

9 Dial keypad (TONE)

10 USB indicator

11 USB jack

12 Desk stand/Wall mounting adaptor

- The adaptor is a removable attachment for desk stand or wall mounting use. (page 8, 44).

13 [ERASE] [CLEAR]

14 [■] (STOP) (EXIT)

15 [ANSWER ON/OFF]

ANSWER ON/OFF indicator

16 [LOCATOR] [INTERCOM]

17 [▶] (PLAY)

Message indicator

18 [HOLD]

19 [REDIAL] [PAUSE]

20 [FLASH] [CALL WAIT]

21 [SP-PHONE] (SP-PHONE: Speakerphone)

SP-PHONE indicator

■ Control type

▲ Soft keys

The base unit features 3 soft keys. By pressing a soft key, you can select the feature shown directly above it on the display.

● Navigator key

- [▲], [▼], [◀], or [▶]: Scroll through various lists and items.
- VOLUME ([▲] or [▼]): Adjust the receiver or speaker volume while talking.
- [◀]/[▶]: Repeat/skip messages during playback.

Handset

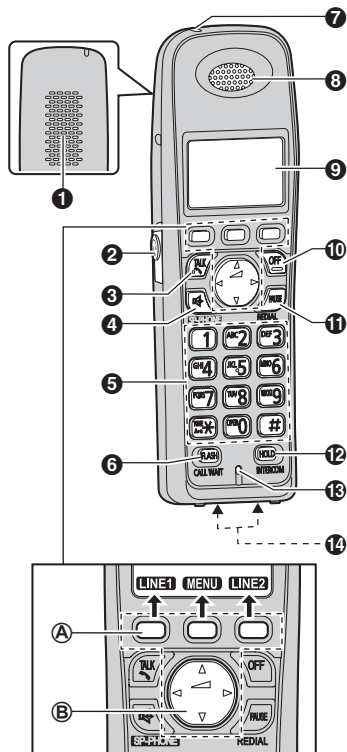

- ❶ Speaker
- ❷ Headset jack
- ❸ [TALK]
- ❹ [SP-PHONE: Speakerphone]
- ❺ Dial keypad (TONE)
- ❻ [FLASH] [CALL WAIT]
- ❼ Charge indicator
Ringer indicator
- ❽ Receiver
- ❾ Display
- ❿ [OFF]
- ⓫ [PAUSE] [REDIAL]
- ⓬ [HOLD] [INTERCOM]
- ⓭ Microphone
- ⓮ Charge contacts

■ Control type

Ⓐ Soft keys

The handset features 3 soft keys. By pressing a soft key, you can select the feature shown directly above it on the display.

Ⓑ Navigator key

- [▲], [▼], [◀], or [▶]: Scroll through various lists and items.
- [◀] (Volume: [▲] or [▼]): Adjust the receiver or speaker volume while talking.

Belt clip

■ To attach

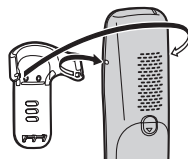

■ To remove



Display/indicators







Base unit display items

Item	Meaning
LINE1	Indicates the selected line(s) for answering system operations and settings.
LINE2	
L1 L2	Ringer volume is off. *1 (page 16)
	Night mode is on. (page 30)
PRIV.	Privacy mode is on. (page 18)

*1 Corresponding line number(s) is indicated next to the item.

Handset display items







Item	Meaning
	Battery level
	Within range of the base unit <ul style="list-style-type: none"> ● When flashing: Handset is searching for the base unit. (page 47)

Item	Meaning
	The line is in use.
	<ul style="list-style-type: none"> When flashing: <ul style="list-style-type: none"> The call is put on hold on that line. The answering system is answering a call on that line. When flashing rapidly: An incoming call is now being received on that line.
	Ringer volume is off.*1 (page 16)
	Speakerphone is on. (page 15)
	Night mode is on. (page 30)
	Alarm is on. (page 30)
	Handset number
PRIV.	Privacy mode is on. (page 18)

*1 Corresponding line number(s) is indicated next to the item.

Main menu icons

The following icons are shown when you press down on the middle soft key in standby mode.

Icon	Feature
	View Caller ID
	Phonebook
	Set answering*1
	Answering device*2
	Ringer settings
	Initial settings
	Customer support

*1 Base unit

*2 Handset

LINE 1 indicator/LINE 2 indicator on the base unit

The LINE 1 indicator and LINE 2 indicator show the status of each line, respectively, as follows.

Status	Meaning
Light off	The line is available.
Light on	The line is in use.
Flashing rapidly	A call is being received.
Flashing	A call is put on hold or the answering system is answering a call.

USB indicator on the base unit

Status	Meaning
Light off	"Telephone Plug-in" is not active.
Light on	"Telephone Plug-in" is active.



Initial settings

■ Direct command code:

Programmable settings can be accessed by pressing **[MENU]**, **[#]** and then the corresponding code on the dial keypad (page 26).

Example: Press **[MENU][#][1][1][0]**.

■ Symbol meaning:

Symbol	Meaning
	Perform with the base unit.
	Perform with the handset.
Example:  : "Off"	Press [▼] or [▲] to select the words in quotations.

Date and time

Program this setting using either the base unit or one of the handsets.

Base unit / Handset

- [MENU][#][1][0][1]**
- Enter the current month, date, and year by selecting 2 digits for each.
Example: July 15, 2011
[0][7][1][5][1][1]
- Enter the current hour and minute (12-hour clock format) by selecting 2 digits for each.
Example: 9:30
[0][9][3][0]
- [X]**: Select "AM" or "PM". → **[SAVE]**
- Proceed with the operation for your unit.
Base unit: **[■]** (EXIT)
Handset: **[OFF]**

Note:

- When English is selected as the display language, 12-hour clock format is used. When Spanish is selected, 24-hour clock format is used.

- The date and time may be incorrect after a power failure. In this case, set the date and time again.

Display language

You can select either “English” or “Español” as the display language. The default setting is “English”.

Base unit / Handset

- 1 **[MENU]** **#** **1** **1** **0**
- 2 **[↓]**: Select the desired setting. → **[SAVE]**
- 3 Proceed with the operation for your unit.
Base unit: **[■]** (EXIT)
Handset: **[OFF]**

Voice guidance language

You can select either “English” or “Español” as the voice guidance language of the answering system. The default setting is “English”. Program this setting using either the base unit or one of the handsets.

Base unit / Handset

- 1 **[MENU]** **#** **1** **1** **2**
- 2 **[↓]**: Select the desired setting. → **[SAVE]**
- 3 Proceed with the operation for your unit.
Base unit: **[■]** (EXIT)
Handset: **[OFF]**

Dialing mode

If you cannot make calls, change this setting according to your telephone line service. The default setting is “Tone”.

“Tone”: For tone dial service.

“Pulse”: For rotary/pulse dial service.

Program this setting using either the base unit or one of the handsets.

Base unit / Handset

- 1 **[MENU]** **#** **1** **2** **0**
- 2 **[↓]**: Select the desired setting. → **[SAVE]**
- 3 Proceed with the operation for your unit.
Base unit: **[■]** (EXIT)
Handset: **[OFF]**

Line selection mode

The line selection mode determines which line is selected when:

- you lift the corded handset
- you press **[☎]** on the base unit (when making/answering calls)
- you press **[☎]**/**[☎]** on the handset (when making/answering calls)

The following setting is available:

- “Auto” (default): When making a call, line 1 is selected. If that line is unavailable, line 2 is selected. When you call back using the caller list (page 32) or while listening to a message (page 36, 37), the indicated line is used. When answering a call, the ringing line is selected.
- “Line1”: Line 1 is selected.
- “Line2”: Line 2 is selected.

Base unit / Handset

- 1 **[MENU]** **#** **2** **5** **0**
- 2 **[↓]**: Select the desired setting. → **[SAVE]**
- 3 Proceed with the operation for your unit.
Base unit: **[■]** (EXIT)
Handset: **[OFF]**

Note:

- You can select a line manually regardless of the line selection mode by pressing **[LINE 1]** or **[LINE 2]**.

Making calls

Using the base unit

- 1 Dial the phone number.
 - To correct a digit, press **[CLEAR]**.
- 2 Lift the corded handset.
 - An available line is automatically selected and either the LINE 1 indicator or LINE 2 indicator lights up. To change the line selection mode, see page 14.
 - You can also select the line manually by pressing **[LINE 1]** or **[LINE 2]** before lifting the corded handset.
- 3 When you finish talking, place the corded handset on the cradle.

Note:

- You can also dial the phone number after lifting the corded handset.
- To switch to the cordless handset, press **[LINE 1]** or **[LINE 2]** on the cordless handset, then place the corded handset on the cradle.

Using the speakerphone

- 1 During a conversation with the corded handset, press **[☎]** to turn on the speakerphone.
 - You can place the corded handset on the cradle.
 - Speak into the base unit microphone.
 - Speak alternately with the other party.
- 2 When you finish talking, press **[☎]**.

Note:

- For best performance, use the speakerphone in a quiet environment.
- To switch to the receiver, lift the corded handset.

Using the handset

- 1 Lift the handset and dial the phone number.
 - To correct a digit, press **[CLEAR]**.
- 2 Press **[☎]**.
 - An available line is automatically selected and the line number is displayed. To change the line selection mode, see page 14.
 - You can also select the line manually by pressing **[LINE 1]** or **[LINE 2]**.

- 3 When you finish talking, press **[OFF]** or place the handset on the charger.

Note:

- The LINE 1 indicator or LINE 2 indicator on the base unit lights up while using the handset.

Using the speakerphone

- 1 Dial the phone number and press **[☎]**.
 - Speak alternately with the other party.
- 2 When you finish talking, press **[OFF]**.

Note:

- For best performance, use the speakerphone in a quiet environment.
- To switch back to the receiver, press **[☎]**.

Adjusting the receiver or speaker volume

Base unit / Handset

Press **[▲]** or **[▼]** repeatedly while talking.

Making a call using the redial list

Base unit / Handset

The last 10 phone numbers dialed are stored in the redial list (each 48 digits max.).

- 1 **[REDIAL]**
- 2 **[↕]**: Select the desired phone number.
- 3 Proceed with the operation for your unit.
Base unit: Lift the corded handset.
Handset: **[☎]**

Erasing a number in the redial list

- 1 **[REDIAL]**
- 2 **[↕]**: Select the desired phone number. → **[ERASE]** (Soft key)
- 3 **[↕]**: “Yes” → **[SELECT]**
- 4 Proceed with the operation for your unit.
Base unit: **[■]** (EXIT)
Handset: **[OFF]**

Pause (for PBX/long distance service users)



A pause is sometimes required when making calls using a PBX or long distance service. When storing a calling card access number and/or PIN in

Making/Answering Calls

the phonebook, a pause is also needed (page 25).

Example: If you need to dial the line access number "9" when making outside calls with a PBX:

Base unit / Handset

- 1  → [PAUSE]
- 2 Dial the phone number.
- 3 Proceed with the operation for your unit.
Base unit: Lift the corded handset.
Handset: [



Note:

- A 3.5 second pause is inserted each time [PAUSE] is pressed. Repeat as needed to create longer pauses.



Answering calls







Using the base unit

When a call is being received, the LINE 1 indicator and/or LINE 2 indicator on the base unit flashes rapidly.

- 1 Lift the corded handset or press [] when the unit rings.
 - The called line is automatically selected. To change the line selection mode, see page 14.
 - You can also answer the call by pressing [LINE 1] or [LINE 2].
- 2 When you finish talking, place the corded handset on the cradle. When the speakerphone is used, press [].

Using the handset

When a call is being received, the ringer indicator and  and/or  flashes rapidly.

- 1 Lift the handset and press [] or [] when the unit rings.
 - The called line is automatically selected. To change the line selection mode, see page 14.
 - You can also answer the call by pressing [LINE 1] or [LINE 2].
 - You can also answer the call by pressing any dial key from  to , , or . (**Any key answer feature**)





- 2 When you finish talking, press [OFF] or place the handset on the charger.

Auto talk

You can answer calls simply by lifting the handset off the charger. You do not need to press []. To turn this feature on, see page 28.

Adjusting the ringer volume

Base unit /

- **While the unit is ringing for an incoming call:**
Press [] or [] repeatedly to select the desired volume.
- **Programming the volume beforehand:**
 - 1 [MENU]#160
 - 2 []: Select the desired line. → [SELECT]
 - 3 []: Select the desired volume. → [SAVE]
 - 4 Proceed with the operation for your unit.
Base unit: [] (EXIT)
Handset: [OFF]

Temporary ringer off

Base unit /

While the unit is ringing for a call, you can turn the ringer off temporarily by pressing [] on the base unit or [OFF] on the handset.

Useful features during a call

Hold

This feature allows you to put an outside call on hold.

Base unit

- 1 Press [HOLD] during an outside call.
 - If you are using the corded handset, you can place it on the cradle.
- 2 To release hold, press [LINE 1] or [LINE 2] that is flashing on the base unit.

Handset

- 1 Press [HOLD] 2 times during an outside call.

- 2 To release hold, press **[LINE 1]** or **[LINE 2]** that is flashing on the handset.

Note for base unit and handset:

- If a call is kept on hold for more than 9 minutes, an alarm tone starts to sound and the ringer indicator on the handset flashes rapidly. After 1 additional minute on hold, the call is disconnected.
- If another phone is connected to the same line, you can also take the call by lifting its handset.

Mute

While mute is turned on, you can hear the other party, but the other party cannot hear you.

 **Base unit** /  **Handset**

- 1 Press **[MUTE]** during conversation.
 - **[MUTE]** flashes.
- 2 To return to the conversation, press **[MUTE]** again.

Note:

- **[MUTE]** is a soft key visible on the display during a call.

Flash

 **Base unit** /  **Handset**

[FLASH] allows you to use the special features of your host PBX such as transferring an extension call, or accessing optional telephone services.

Note:

- To change the flash time, see page 28.

For call waiting or Call Waiting Caller ID service users

To use call waiting or Call Waiting Caller ID, you must first subscribe with your service provider/telephone company.

This feature allows you to receive calls while you are already talking on the phone. If you receive a call while on the phone, you will hear a call waiting tone.

If you subscribe to both Caller ID and Call Waiting with Caller ID services, the 2nd caller's information is displayed on the base unit or handset that is in use after you hear the call waiting tone.

 **Base unit** /  **Handset**

- 1 Press **[CALL WAIT]** to answer the 2nd call.
- 2 To switch between calls, press **[CALL WAIT]**.

Note:

- Please contact your service provider/telephone company for details and availability of this service in your area.

Temporary tone dialing (for rotary/pulse service users)

You can temporarily switch the dialing mode to tone when you need to access touch-tone services (for example, answering services, telephone banking services, etc.).

 **Base unit** /  **Handset**

Press **[TONE]** before entering access numbers which require tone dialing.

Call share

You can join an existing outside call.

 **Base unit**

To join the conversation, press **[LINE 1]** or **[LINE 2]** to select the line that is being used by another extension for an outside call, then lift the corded handset.

 **Handset**

To join the conversation, press **[LINE 1]** or **[LINE 2]** to select the line that is being used by another extension for an outside call.

Note for base unit and handset:

- A maximum of 3 parties (including 1 outside party) can join a conversation. **(3-way conference)**

Privacy mode

When the privacy mode is "On", the unit prevents other users from joining your conversations with outside callers. You can turn the feature on for both lines by programming the base unit before the call. To allow other users to join your conversations, leave this feature off. The default setting is "Off".

Base unit

- 1 **[MENU]** **#** **1** **9** **4**
- 2 **[↕]**: “On” or “Off” → **[SAVE]**
- 3 **[■]** (EXIT)
 - When this feature is turned on, “PRIV.” is displayed during an outside call.

Temporarily turning call privacy on/off

During an outside call, you can temporarily turn call privacy on/off.

Base unit

- 1 Press **[MENU]** during an outside call.
 - If any options appear on the display, perform the following:
[↕]: “Privacy” → **[SELECT]**
- 2 **[↕]**: “On” or “Off” → **[SELECT]**
 - When this feature is turned on, “PRIV.” is displayed.

Handset

- 1 Press **[MENU]** during an outside call.
- 2 **[↕]**: “Privacy” → **[SELECT]**
- 3 **[↕]**: “On” or “Off” → **[SELECT]**
 - When this feature is turned on, “PRIV.” is displayed.

Note for base unit and handset:

After you hang up the call, the feature will return to the setting programmed on page 17.

Using the other line during a call

You can use the other line in the following ways:

- When a call is being received on the other line during a conversation, an interrupt tone will be heard (page 28). You can answer the 2nd call while holding the 1st call.
- During an outside call, you can also make a call using the other line by holding the 1st call.

Base unit

Example: If you are using line 1:

- 1 Press **[HOLD]** to put the 1st call (line 1) on hold.
- 2 Press **[LINE 2]** to make or answer a 2nd call.
 - To hold the 2nd call, press **[HOLD]**.

- 3 To return to the 1st call (line 1), press **[LINE 1]**.

Handset

Example: If you are using line 1:

- 1 Press **[HOLD]** 2 times to put the 1st call (line 1) on hold.
- 2 Press **[LINE 2]** to make or answer a 2nd call.
 - To hold the 2nd call, press **[HOLD]** 2 times.
- 3 To return to the 1st call (line 1), press **[LINE 1]**.

Note for base unit and handset:

- If you subscribe to Caller ID, the 2nd caller's information is displayed when a call is being received on the other line (page 32).

“Telephone Plug-in” settings

System requirements

Item	Specifications
CPU	1.0 GHz Intel® Pentium®/Celeron® processor or comparable CPU or higher processor
RAM	512 MB or more
OS	<ul style="list-style-type: none"> ● Microsoft Windows® XP Service Pack 3 or later (32-bit only) ● Microsoft Windows Vista® Service Pack 2 or later ● Microsoft Windows 7 Service Pack 1 or later
Microsoft Office Outlook	<ul style="list-style-type: none"> ● Microsoft Office Outlook 2003 Service Pack 3 or later ● Microsoft Office Outlook 2007 Service Pack 2 or later ● Microsoft Office Outlook 2010 or later (Service Pack)
Hard disk	20 MB or more
Video resolution	1,024 x 768 or higher
Others	<ul style="list-style-type: none"> ● CD-ROM drive ● USB 2.0

Trademarks:

- Microsoft, Windows, Windows Vista, and Outlook are either registered trademarks or trademarks of Microsoft Corporation in the United States and/or other countries.
- Intel, Celeron and Pentium are trademarks of Intel Corporation in the U.S. and other countries.
- All other trademarks identified herein are the property of their respective owners.
- Microsoft product screen shots reprinted with permission from Microsoft Corporation.

Note:

- The screen shot shown is for Microsoft Office Outlook 2010.
- The screen shots shown in these instructions may differ slightly from those of the actual product.
- Software features and appearance are subject to change without notice.

Installing the “Telephone Plug-in”

Before installing “Telephone Plug-in”, make sure of the following:

- Microsoft Office Outlook is installed on your computer.
- The base unit is not connected to your computer with the mini USB cable (until instructed to do so).

- 1 Start Windows and exit all other applications.
 - You must be logged in as an administrator in order to install “Telephone Plug-in”.
- 2 Insert the included CD-ROM into your CD-ROM drive.
 - Installation starts automatically. If the installation does not start, see page 49.
 - **For Microsoft Windows Vista and Microsoft Windows 7 users:** Click **[Run Setup.exe]** when prompted.
- 3 When the language selection window is displayed, select the desired language and click **[Next]**.
- 4 When the “Telephone Plug-in” window is displayed, click **[Next]**.
- 5 Read the license agreement carefully. If you accept the terms of the license agreement, check the box and click **[Next]**.

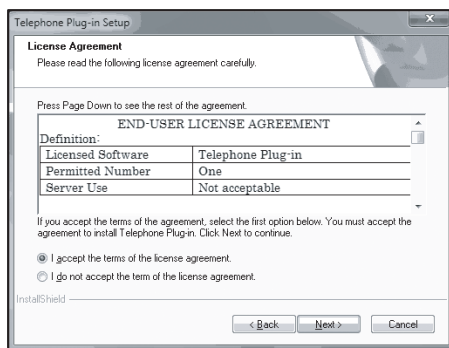

- 6 When the “Telephone Plug-in” install shield wizard is displayed, click **[Install]**.
- 7 When installation is finished, click **[Finish]** to complete the installation. Then remove the CD-ROM from your CD-ROM drive.

Uninstalling the “Telephone Plug-in”

- 1 Exit all applications and disconnect the mini USB cable from your computer.
- 2 To uninstall “Telephone Plug-in”, perform the following procedure:
From the Start menu:
Point to **[All Programs]** → **[Panasonic]** → **[Telephone Plug-in]**, and click **[Uninstall]**.
- 3 When the uninstall confirmation window is displayed, click **[Yes]** to start uninstallation.
- 4 When uninstallation is finished, click **[Finish]** to exit the uninstallation.

Connecting a computer to the base unit with mini USB cable

“Telephone Plug-in” must be installed before connecting the base unit to your computer.

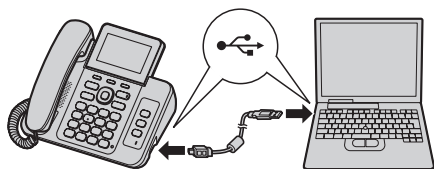

Making a call from “Telephone Plug-in”

When “Telephone Plug-in” is installed correctly, a toolbar appears in the Microsoft Office Outlook display. You can make calls from the base unit speakerphone using the toolbar.

Making a call from the Microsoft Outlook contact list

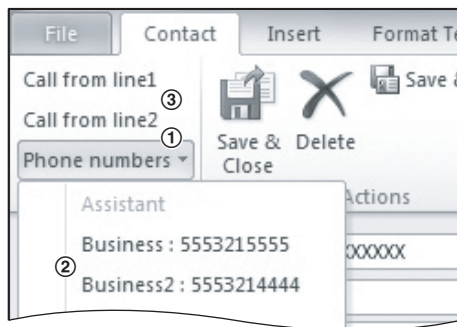

Microsoft Office Outlook 2010 users

- 1 Find and double click the desired contact.
- 2 Click **[Phone numbers ▼]**. ----(①)
- 3 Click the phone number you want to call. ----(②)
- 4 Click **[Call from line1]** or **[Call from line2]** to select the desired line. ----(③)
 - The base unit automatically dials the number with the speakerphone.

Microsoft Office Outlook 2003/2007 users

- 1 Find and double click the desired contact.
- 2 Click **[Call from line1]** or **[Call from line2]** to select the desired line. ----(③)
- 3 Click **[Phone numbers ▼]**. ----(①)
- 4 Click the phone number you want to call. ----(②)
 - The base unit automatically dials the number with the speakerphone.

Making a call from the caller list

The last 10 caller information is stored in the caller list.

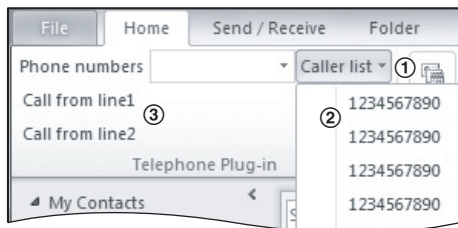

Microsoft Office Outlook 2010 users

- 1 Click **[Caller list ▼]**. ----(1)
- 2 Click the phone number you want to call. ----(2)
- 3 Click **[Call from line1]** or **[Call from line2]** to select the desired line. ----(3)

Microsoft Office Outlook 2003/2007 users

- 1 Click **[Call from line1]** or **[Call from line2]** to select the desired line. ----(3)
- 2 Click **[Caller list ▼]**. ----(1)
- 3 Click the phone number you want to call. ----(2)

Making a call by entering a phone number in the toolbar

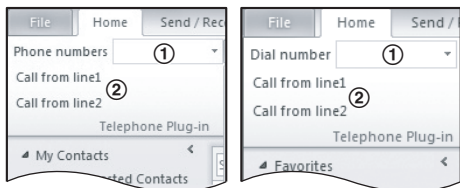

Microsoft Office Outlook 2010 users

- 1 Enter the phone number in the toolbar. ----(1)
 - Only the following keys are accepted (max. 24 digits):
0 to 9, *, #, p (Pause), and f (Flash)
- 2 Click **[Call from line1]** or **[Call from line2]** to select the desired line. ----(2)

Microsoft Office Outlook 2003/2007 users

- 1 Click **[Call from line1]** or **[Call from line2]** to select the desired line. ----(2)
- 2 Enter the phone number in the toolbar. ----(1)
 - Only the following keys are accepted (max. 24 digits):
0 to 9, *, #, p (Pause), and f (Flash)
- 3 Press the Enter key on your computer to dial the number.

Making a call from the redial list

When you are using functions other than the **contact list**, you can make a call from the redial list. Confirm **[Dial number]** is displayed in the toolbar. The last 10 phone numbers dialed are stored in the redial list (each 24 digits max.).

Microsoft Office Outlook 2010 users

- 1 Click **[▼]** displayed to the right of **[Dial number]**.
- 2 Click the phone number you want to call.
- 3 Click **[Call from line1]** or **[Call from line2]** to select the desired line.

Microsoft Office Outlook 2003/2007 users

- 1 Click **[Call from line1]** or **[Call from line2]** to select the desired line.
- 2 Click **[▼]** displayed to the right of **[Dial number]**.
- 3 Click the phone number you want to call.

Hanging up a call

When you finish a call, press **[⏏]** on the base unit or **[Disconnect line1]** or **[Disconnect line2]** in the toolbar.

“Telephone Plug-in” pop-up window for incoming call

When a call is received, “Telephone Plug-in” displays a pop-up window (Microsoft Office Outlook contact list) on your computer display to let you know there is an incoming call.

- If the caller’s phone number does not match a contact in the Microsoft Office Outlook contact list, a new contact window is displayed with the Caller ID information for the caller (if the Caller ID information contains the name and phone number). You can edit the contact information in the window and store it as a new contact.
- To call back the caller displayed on the pop-up window, click **[Call from line1]** or **[Call from line2]** to select the desired line.

Important:

- To use “Telephone Plug-in” features, you must subscribe to a Caller ID service. Contact your service provider/telephone company for details.

“Telephone Plug-in” toolbar settings

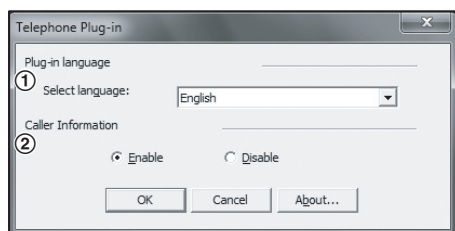

- 1 Click **[Options]** in the toolbar.
- 2 Change the following settings as necessary.
 - **Plug-in language** ----(①)
You can select “English”, “Français”, or “Español”.
 - **Caller Information** ----(②)
You can select whether the pop-up window is displayed or not.
“Enable” (default): Displays a Microsoft Office Outlook contact window.
“Disable”: Does not display a pop-up window.
- 3 Click **[OK]** to complete the changes.

Base unit/handset phonebook

The phonebook allows you to make calls without having to dial manually. You can add names and phone numbers to the base unit and handset phonebook independently, and assign each phonebook entry to the desired group.

- Base unit: up to 100 entries
- Handset: up to 100 entries

Important:

- Caller ID subscribers can use group ringer tone features (page 32).

Adding entries

Base unit / Handset



- Proceed with the operation for your unit.
Base unit: [
Handset: [MENU]# [2] [8] [0]
- [ADD]
- Enter the party's name (16 characters max.).
→ [OK]
- Enter the party's phone number (24 digits max.). → [OK]
- [↕]: Select the desired group. → [SELECT]
2 times
 - To add other entries, repeat from step 3.
- Proceed with the operation for your unit.
Base unit: [■] (EXIT)
Handset: [OFF]

Character table for entering names





While entering characters, you can switch between uppercase and lowercase by pressing  (A→a).

Key	Character
[1]	_ # & ' () * , - . / 1
[2]	A B C 2 a b c 2
[3]	D E F 3 d e f 3
[4]	G H I 4 g h i 4

Key	Character
[5]	J K L 5 j k l 5
[6]	M N O 6 m n o 6
[7]	P Q R S 7 p q r s 7
[8]	T U V 8 t u v 8
[9]	W X Y Z 9 w x y z 9
[0]	_ 0

- To enter another character that is located on the same dial key:
Base unit: Press [] to move the cursor to the next space.
Handset: Press [] to move the cursor to the next space.
- _ in the above table represents a single space.

Erasing the character or number

Base unit: Press [] or []. → [CLEAR]
Handset: Press [] or []. → [CLEAR]

- Press and hold [CLEAR] to erase all characters or numbers.

Groups

Groups can help you find entries in the phonebook quickly and easily. When adding an entry to the phonebook, you can assign it to one of 9 groups. You can change the names of groups assigned for phonebook entries ("Friends", "Family", etc.) and then search for phonebook entries by group. The group ringer tone feature is available for Caller ID subscribers (page 32).

Changing group names

The default group name is "Group 1" to "Group 9".

Base unit / Handset

- Proceed with the operation for your unit.
Base unit: [
Handset: [MENU]# [2] [8] [0]
- [MENU]
- [↕]: "Group" → [SELECT]

Phonebook

- 4 **[↕]**: Select the desired group. → **[SELECT]**
- 5 **[↕]**: "Group name" → **[SELECT]**
- 6 Edit the name (10 characters max.; page 23). → **[SAVE]**
- 7 Proceed with the operation for your unit.
Base unit: **[■]** (EXIT)
Handset: **[OFF]**

Finding and calling from a phonebook entry

Base unit / Handset

Once you have found the desired entry using one of the following 3 methods, make a call with your unit.

Base unit: Lift the corded handset.

- You can also make a call by pressing **[LINE 1]** or **[LINE 2]**, then lifting the corded handset.

Handset: **[↶]**

- You can also make a call by pressing **[CALL]**, then pressing **[LINE 1]** or **[LINE 2]**.

Scrolling through all entries

- 1 Proceed with the operation for your unit.
Base unit: **[↶]**
Handset: **[MENU]#280**
- 2 **[↕]**: Select the desired entry.

Searching by first character

- 1 Proceed with the operation for your unit.
Base unit: **[↶]**
Handset: **[MENU]#280**
- 2 Press the dial key (**[0]** – **[9]**) which contains the character you are searching for (page 23).
 - Press the same dial key repeatedly to display the first entry corresponding to each character located on that dial key.
 - If there is no entry corresponding to the character you selected, the next entry is displayed.
- 3 **[↕]**: Scroll through the phonebook if necessary.

Searching by group

- 1 Proceed with the operation for your unit.
Base unit: **[↶]**
Handset: **[MENU]#280**
- 2 **[GROUP]**

- 3 **[↕]**: Select the group you want to search. → **[SELECT]**
 - If you select "All groups", the unit ends the group search.
- 4 **[↕]**: Select the desired entry.

Editing entries

Base unit / Handset

- 1 Find the desired entry (page 24). → **[MENU]**
- 2 **[↕]**: "Edit" → **[SELECT]**
- 3 Edit the name if necessary (16 characters max.; page 23). → **[OK]**
- 4 Edit the phone number if necessary (24 digits max.). → **[OK]**
- 5 **[↕]**: Select the desired group (page 23). → **[SELECT]** 2 times
- 6 Proceed with the operation for your unit.
Base unit: **[■]** (EXIT)
Handset: **[OFF]**

Erasing entries

Base unit / Handset

Erasing an entry

- 1 Find the desired entry (page 24). → **[MENU]**
- 2 **[↕]**: "Erase" → **[SELECT]**
- 3 **[↕]**: "Yes" → **[SELECT]**
- 4 Proceed with the operation for your unit.
Base unit: **[■]** (EXIT)
Handset: **[OFF]**



Erasing all entries

- 1 Proceed with the operation for your unit.
Base unit: **[↶]**
Handset: **[MENU]#280**
- 2 **[MENU]**
- 3 **[↕]**: "Erase all" → **[SELECT]**
- 4 **[↕]**: "Yes" → **[SELECT]**
- 5 **[↕]**: "Yes" → **[SELECT]**
- 6 Proceed with the operation for your unit.
Base unit: **[■]** (EXIT)
Handset: **[OFF]**

Chain dial

This feature allows you to dial phone numbers in the phonebook while you are on a call. This feature can be used, for example, to dial a calling card access number or bank account PIN that you have stored in the phonebook, without having to dial manually.

Base unit / Handset

- 1 Proceed with the operation for your unit.
During an outside call:
Base unit: [**]**
Handset: **[MENU]** → []: “Phonebook” → **[SELECT]**
- 2 []: Select the desired entry.
- 3 Press **[CALL]** to dial the number.

Note:

- When storing a calling card access number and your PIN in the phonebook as one phonebook entry, press **[PAUSE]** to add pauses after the number and PIN as necessary (page 15).
- If you have rotary/pulse service, you need to press **[*]** (TONE) before pressing [**]** on the base unit or **[MENU]** on the handset in step 1 to change the dialing mode temporarily to tone. When adding entries to the phonebook, we recommend adding **[*]** (TONE) to the beginning of phone numbers you wish to chain dial (page 23).

Copying phonebook entries



You can copy phonebook entries from the base unit to a handset or vice versa.



Important:

- Group ringer tones are not copied.
- You cannot copy the phonebook entries between handsets.



Copying an entry

Base unit

- 1 [**]**
- 2 []: Select the desired entry. → **[MENU]**
- 3 []: “Copy” → **[SELECT]**



- 4 Enter the handset number to copy to.
 - When an entry has been copied, “Completed” is displayed.
 - To continue copying another entry:
[]: “Yes” → **[SELECT]** → Find the desired entry (page 24). → **[SEND]**
- 5 [] (EXIT)

Handset

- 1 **[MENU]** **#[2][8][0]**
- 2 []: Select the desired entry. → **[MENU]**
- 3 []: “Copy to base” → **[SELECT]**
 - When an entry has been copied, “Completed” is displayed.
 - To continue copying another entry:
[]: “Yes” → **[SELECT]** → Find the desired entry (page 24). → **[SEND]**
- 4 **[OFF]**

Copying all entries

Base unit

- 1 [**]** → **[MENU]**
- 2 []: “Copy all” → **[SELECT]**
- 3 Enter the handset number to copy to.
 - When all entries have been copied, “Completed” is displayed.
- 4 [] (EXIT)

Handset

- 1 **[MENU]** **#[2][8][0]** → **[MENU]**
- 2 []: “Copy all to base” → **[SELECT]**
 - When all entries have been copied, “Completed” is displayed.
- 3 **[OFF]**

Programmable settings

You can customize the unit by programming the following features.
To access the features, there are 2 methods.

Base unit / Handset





■ Scrolling through the display menus

- 1 **[MENU]**
- 2 Proceed with the operation for your unit.
Base unit: Press **[▲]**, **[▼]**, **[◀◀]**, or **[▶▶]** to select the desired main menu. → **[SELECT]**
Handset: Press **[▲]**, **[▼]**, **[◀]**, or **[▶]** to select the desired main menu. → **[SELECT]**
- 3 Press **[▼]** or **[▲]** to select the desired item from the next sub-menus. → **[SELECT]**
- 4 Press **[▼]** or **[▲]** to select the desired setting. → **[SAVE]**
 - This step may vary depending on the feature being programmed.
 - To exit the operation, press **[■]** (EXIT) on the base unit or **[OFF]** on the handset.

■ Using the direct command code



- 1 **[MENU]** → Enter the desired code.
Example: Press **[MENU][#][1][1][0]**.
- 2 Select the desired setting. → **[SAVE]**
 - This step may vary depending on the feature being programmed.
 - To exit the operation, press **[■]** (EXIT) on the base unit or **[OFF]** on the handset.

Note:



- The unit column shows the unit(s) that can be used to program the item.
: Only the base unit can program the item.
: Only the handset can program the item.
: Both the base unit and handset can program the item.
- In the following table, < > indicates the default settings.
- In the following table,  indicates the reference page number.

Display the menu tree and direct command code table



Main menu:  "View Caller ID"







Operation	Code	Unit	
Viewing the caller list.	#213		32

Main menu:  "Phonebook"









Operation	Code	Unit	
Viewing and erasing the phonebook entry.	#280		24

(Base unit) Main menu:  "Set answering"





Sub-menu 1	Sub-menu 2	Settings	Code	Unit	
Record greeting	Line1&Line2	—	#302		35
	Line1	—			
	Line2	—			

Sub-menu 1	Sub-menu 2	Settings	Code	Unit	
Play greeting	Line1&Line2	–	#303		36
	Line1	–			
	Line2	–			
Ring count* ¹	–	Toll saver 2-7 rings <4 rings>	#211		39
Recording time* ¹	–	1 min 2 min <3 min>	#305		40
Remote code* ¹	–	<111>	#306		38
Call screening	–	<On> Off	#310		35







(Handset) Main menu:  “Answering device”

Sub-menu 1	Sub-menu 2	Settings	Code	Unit	
Play new msg. (msg.: message)	–	–	#323		37
Play all msg.	–	–	#324		37
Erase all* ¹	–	–	#325		37
Settings	Ring count* ¹	Toll saver 2-7 rings <4 rings>	#211		39
	Recording time* ¹	1 min 2 min <3 min>	#305		40
	Remote code* ¹	<111>	#306		38
	Call screening	<On> Off	#310		35























Main menu:  “Ringer settings”









Sub-menu 1	Sub-menu 2	Settings	Code	Unit	
Ringer volume* ²	Line1	Base unit: Level 1-3 <3> Off Handset: Level 1-6 <6> Off	#160	 	16
	Line2				
Ringer tone* ^{3, *4, *5}	Line1	Line1: <Tone 1> Line2: <Tone 2> Base unit: Tone 1-3 Melody 1-3 Handset: Tone 1-5 Melody 1-10	#161	 	–
	Line2				

Programming

Sub-menu 1	Sub-menu 2	Settings	Code	Unit	
Interrupt tone*6	–	<On> Off	#201	 	18, 42
Night mode	Start/End	<11:00 PM/06:00 AM>	#237	 	30
	On/Off	On <Off>	#238	 	30

Main menu: “Initial settings”

Sub-menu 1	Sub-menu 2	Settings	Code	Unit	
Set date & time	Date and time*1	–	#101	 	13
	Alarm	<Off> Once Daily	#720		30
	Time adjustment*1,*7	<Caller ID[auto]> Manual	#226	 	–
Contrast (Display contrast)	–	Level 1–6 <3>	#145	 	–
Key tone*8	–	<On> Off	#165		–
Auto talk*9	–	On <Off>	#200		16
Line select	–	<Auto> Line1 Line2	#250	 	14
Set tel line	Caller ID edit (Caller ID number auto edit)	<On> Off	#214	 	33
	Set dial mode*1	<Tone> Pulse	#120	 	14
	Set flash time*1,*10 – Line1 – Line2	80 ms 90 ms 100 ms 110 ms 160 ms 200 ms 250 ms 300 ms 400 ms 600 ms <700 ms> 900 ms	#121	 	17
	Set line mode*1,*11 – Line1 – Line2	A 	#122	 	–
	VM tone detect*1 (VM: Voice mail)	<On> Off	#332	 	41

Sub-menu 1	Sub-menu 2	Settings	Code	Unit	
Privacy	–	On <Off>	#194		17
Registration	HS registration (HS: Handset)	–	#130		31
	Deregistration	–	#131		31
Change language	Display language	<English> Español	#110	 	14
	Voice prompt*1	<English> Español	#112	 	14

Main menu:  "Customer support"*12

Operation	Code	Unit	
Displaying customer support Web address.	#680	 	–

- *1 If you program these settings using one of the handsets, you do not need to program the same item using another handset.
- *2 Ringer volume cannot be turned off for alarm, intercom calls, and paging.
- *3 If you subscribe to a distinctive ring service (such as IDENT-A-RING), select a tone (base unit: tone 1 to 3/handset: tone 1 to 5). If you select a melody, you cannot distinguish lines by their ringers.
- *4 If you select one of the melody ringer tones, the ringer tone continues to play for several seconds even if the caller has already hung up. You may either hear a dial tone or no one on the line when you answer the call.
- *5 The preset melodies in this product are used with permission of © 2007 Copyrights Vision Inc.
- *6 This tone lets you know when you receive an outside call while you are on the other line or an intercom call. If you select "On", the tone sounds 2 times.
- *7 This feature allows the unit to automatically adjust the date and time each time caller information including date and time is received.
To turn this feature on, select "Caller ID [auto]". To turn this feature off, select "Manual". (Caller ID subscribers only)
To use this feature, set the date and time first (page 13).
- *8 Turn this feature off if you prefer not to hear key tones while you are dialing or pressing any keys, including confirmation tones and error tones.
- *9 If you subscribe to a Caller ID service and want to view the caller's information after lifting up the handset to answer a call, turn off this feature.
- *10 The flash time depends on your telephone exchange or host PBX. Contact your PBX supplier if necessary. The setting should stay at "700 ms" unless pressing **[FLASH]** fails to pick up the waiting call.
- *11 Generally, the line mode setting should not be changed. If the LINE 1 indicator or LINE 2 indicator does not light when another phone connected to the same line is in use, you need to change the line mode to "A".
- *12 The base unit and handset can display the Internet address where you can download the operating instructions or get further information for this product, using your computer.

Special programming

Night mode

Night mode allows you to select a period of time during which the unit will not ring for outside calls. This feature is useful for time periods when you do not want to be disturbed, for example, while sleeping. Night mode can be set independently for each base unit and handset.

Important:

- Set the date and time beforehand (page 13).
- If you have set the alarm, the alarm sounds even if the night mode is turned on.

Setting the start and end time

Base unit / Handset

- 1 **[MENU]** **#** **2** **3** **7**
- 2 Enter the desired hour and minute you wish to start this feature.
- 3 **[X]**: Select “AM” or “PM”. → **[OK]**
- 4 Enter the desired hour and minute you wish to end this feature.
- 5 **[X]**: Select “AM” or “PM”. → **[OK]**
- 6 Proceed with the operation for your unit.
Base unit: **[■]** (EXIT)
Handset: **[OFF]**

Turning night mode on/off

Base unit / Handset

- 1 **[MENU]** **#** **2** **3** **8**
- 2 **[↕]**: Select the desired setting. → **[SAVE]**
- 3 Proceed with the operation for your unit.
Base unit: **[■]** (EXIT)
Handset: **[OFF]**
 - When the night mode is set,  is displayed.

Alarm

An alarm sounds at the set time for 3 minutes once or daily. Alarm can be set for each handset.

Important:

- Set the date and time beforehand (page 13).

Handset

- 1 **[MENU]** **#** **7** **2** **0**
- 2 **[↕]**: Select the desired alarm option. → **[SELECT]**

Off	Turns alarm off. Go to step 7.
Once	An alarm sounds once at the set time.
Daily	An alarm sounds daily at the set time. Go to step 4.

- 3 Enter the desired month and date.
- 4 Set the desired time.
- 5 **[X]**: Select “AM” or “PM”. → **[OK]**
- 6 **[↕]**: Select the desired alarm tone. → **[SELECT]**
 - We recommend selecting a different ringer tone from the one used for outside calls.
- 7 **[SELECT]** → **[OFF]**
 - When the alarm is set,  is displayed.

Note:

- To stop the alarm, press **[OFF]** or place the handset on the charger.
- When the handset is in use, the alarm will not sound until the handset is in standby mode.
- When the ringer volume for outside calls of the 2 lines is set to off (page 27), the alarm sound is heard at a low level.

Registering a unit

Operating additional units

Additional handsets

Up to 6 handsets can be registered to the base unit.

Important:

- See page 4 for information on the available model.

Registering a handset to the base unit

The supplied handset and base unit are pre-registered. If for some reason the handset is not registered to the base unit, re-register the handset.

1 Handset:

[MENU] # **1 3 0**

2 Base unit:

Press and hold **[LOCATOR]** for about 5 seconds until the registration tone sounds.

- If all registered handsets start ringing, press **[LOCATOR]** again to stop, then repeat this step.
- The next step must be completed within 90 seconds.

3 Handset:

Press **[OK]**, then wait until a long beep sounds.

Note:

- When you purchase an additional handset, refer to the additional handset's installation manual for registration.

Deregistering a handset

A handset can cancel its own registration to the base unit, or other handsets registered to the same base unit. This allows the handset to end its wireless connection with the system.

1 [MENU] # **1 3 1**

2 3 3 5 → **[OK]**

- All handsets registered to the base unit are displayed.

3 Select the handset you want to cancel by pressing the desired handset(s) number.

- The selected handset number(s) flashes.

- To cancel a selected handset number, press the number again. The number will stop flashing.

4 [OK] → **[↕]**: "Yes" → **[SELECT]**

- When you cancel a different handset than the one you are now using, press **[OFF]** to exit.

Using Caller ID service

Important:

- This unit is Caller ID compatible. To use Caller ID features, you must subscribe to a Caller ID service. Contact your service provider/telephone company for details.

Caller ID features

Base unit / Handset

When an outside call is being received, the caller's name and phone number are displayed.

Caller information for the last 50 callers is logged in the caller list from the most recent call to the oldest.

- If the unit cannot receive caller information, the following is displayed:
 - “**Out of area**”: The caller dials from an area which does not provide a Caller ID service.
 - “**Private caller**”: The caller requests not to send caller information.
 - “**Long distance**”: The caller makes a long distance call.
- If the unit is connected to a PBX system, caller information may not be properly received. Contact your PBX supplier.

Missed calls

Base unit / Handset

If a call is not answered, the unit treats it as a missed call. The display shows “**Missed call**”. This lets you know if you should view the caller list to see who called while you were away.

Phonebook name display

When caller information is received and it matches a phone number stored in the phonebook, the stored name in the phonebook is displayed and logged in the caller list.

Ringer ID

This feature can help you identify who is calling by using different ringer tones for different groups of callers. When adding an entry to the phonebook, you can assign it to the desired group (page 23). When a call is received from a caller assigned to a group, the ringer you selected for that group rings

after caller information is displayed. If you select “**No ringer ID**” (default), the unit uses the ringer tone you selected on page 27 when calls from this group are received.

Base unit / Handset

- 1 Proceed with the operation for your unit.
Base unit: [MENU]
Handset: [MENU]# [2] [8] [0]
- 2 [MENU]
- 3 [↕]: “**Group**” → [SELECT]
- 4 [↕]: Select the desired group. → [SELECT]
- 5 [↕]: Select the current setting of the ringer ID. → [SELECT]
- 6 [↕]: Select the desired ringer tone. → [SAVE]
- 7 Proceed with the operation for your unit.
Base unit: [END] (EXIT)
Handset: [OFF]

Caller list

Important:

- Only 1 person can access the caller list at a time.
- Make sure the unit's date and time setting is correct (page 13).

Viewing the caller list and calling back

Base unit / Handset

- 1 Proceed with the operation for your unit.
Base unit: [CID]
Handset: [MENU]# [2] [1] [3]
- 2 Press [▼] to search from the most recent call, or [▲] to search from the oldest call.
- 3 Proceed with the operation for your unit.
Base unit:
 - To call back, lift the corded handset.
 - To exit, press [END] (EXIT).**Handset:**
 - To call back, press [↶].
 - To exit, press [OFF].

Note:

- In step 2;
 - [1] and [2] indicate which line the caller information was received from.

- If the entry has already been viewed or answered, “✓” is displayed, even if it was viewed or answered using another unit.
- In step 2, if ► is displayed, not all of the information is shown. To see the remaining information:
Base unit:
 Press [▶▶]. To return to the previous screen, press [◀◀].
Handset:
 Press [▶]. To return to the previous screen, press [◀].
- In step 3, the unit automatically uses the line you set in line selection mode (page 14) to call back. When the line selection mode is set to “Auto”, the indicated line (L1 or L2) is used for the call. If the indicated line is already being used or you want to select the other line:
Base unit: Press [LINE 1] or [LINE 2], then lift the corded handset.
Handset: Press [CALL], then press [LINE 1] or [LINE 2].

Editing a caller’s phone number before calling back

You can edit a phone number in the caller list by removing its area code and/or the long distance code “1”.

Base unit / Handset

- 1 Proceed with the operation for your unit.
Base unit: [CID]
Handset: [MENU]# [2] [1] [3]
- 2 Proceed with the operation for your unit.
Base unit: [↕]: Select the desired entry.
Handset: [↕]: Select the desired entry. → [CALL]
- 3 Press [EDIT] repeatedly until the phone number is shown in the desired format.
 - ① Local phone number
Example: 321-5555
 - ② Area code – Local phone number
Example: 555-321-5555
 - ③ 1 – Area code – Local phone number
Example: 1-555-321-5555
- 4 Proceed with the operation for your unit.
Base unit: Lift the corded handset.
Handset: [↶]

- If the indicated line is already being used or you want to select the other line:
Base unit: Press [LINE 1] or [LINE 2], then lift the corded handset.
Handset: Press [LINE 1] or [LINE 2].

Caller ID number auto edit feature

Base unit / Handset

Once you call back an edited number, the unit which was used to call back remembers the area code and format of the edited number. The next time someone calls from the same area code, caller information is customized by the unit as follows:

- When the call is being received, the Caller ID number is displayed in the same format as the edited number.
- After the call has ended, the caller’s phone number is displayed in the same format as the edited number, when reviewed from the caller list.

For example, you can use this feature to set the unit to ignore the area code of callers in your area, so that you can call these local numbers using caller information without dialing the area code. To activate this feature, you must edit an entry in the caller list, then call that number. After that, phone numbers from that caller’s area code are edited automatically.

This feature can be set for each unit (page 28). The default setting is “on”.

Note:

- Phone numbers from the 4 most recently edited area codes are automatically edited.
- If you move to another area, you can turn this feature off to erase previously edited area codes. To use this feature again, turn it on and reprogram the area codes you want to edit once again.

Erasing selected caller information

Base unit / Handset

- 1 Proceed with the operation for your unit.
Base unit: [CID]
Handset: [MENU]# [2] [1] [3]
- 2 [↕]: Select the desired entry.
- 3 [ERASE] (soft key) → [↕]: “Yes” → [SELECT]

- 4 Proceed with the operation for your unit.
Base unit: [■] (EXIT)
Handset: [OFF]

Erasing all caller information

Base unit / Handset

- 1 Proceed with the operation for your unit.
Base unit: [CID]
Handset: [MENU]# [2] [1] [3]
- 2 [ERASE] (soft key) → [↕]: “yes” → [SELECT]
- 3 Proceed with the operation for your unit.
Base unit: [■] (EXIT)
Handset: [OFF]

Storing caller information to the phonebook

Base unit / Handset

- 1 Proceed with the operation for your unit.
Base unit: [CID]
Handset: [MENU]# [2] [1] [3]
- 2 Proceed with the operation for your unit.
Base unit: [↕]: Select the desired entry.
Handset: [↕]: Select the desired entry. → [SAVE]
 - To edit the number, press [EDIT] repeatedly until the phone number is shown in the desired format.
- 3 [SAVE]
- 4 Edit the name if necessary (16 characters max.; page 23). → [OK]
- 5 Edit the phone number if necessary (24 digits max.). → [OK]
- 6 [↕]: Select the desired group (page 23). → [SELECT] 2 times
- 7 Proceed with the operation for your unit.
Base unit: [■] (EXIT)
Handset: [OFF]

Answering system

The answering system can answer and record calls for you when you are unavailable to answer the phone.

Important:

- Only 1 person can access the answering system (listen to messages, record a greeting message, etc.) at a time.
- When callers leave messages, the unit records the day and time of each message. Make sure the date and time have been set correctly (page 13).

Memory capacity (including your greeting message)

The total recording capacity is about 40 minutes. A maximum of 64 messages can be recorded.

Note:

- When message memory becomes full:
 - “**Messages full**” is shown on the base unit and handset display.
 - The ANSWER ON/OFF indicator on the base unit flashes rapidly if the answering system is turned on.
 - If you use the pre-recorded greeting message, the unit automatically switches to another pre-recorded greeting message asking callers to call again later.
 - If you recorded your own greeting message, the same message is still announced to callers even though their messages are not recorded.

Turning the answering system on/off

Base unit

- **To turn on:**
Press **[ANSWER SELECT]** repeatedly to select the desired line(s). → **[ANSWER ON/OFF]**
- **To turn off:**
Press **[ANSWER ON/OFF]**.

Note:

- When the answering system is turned on, the ANSWER ON/OFF indicator on the base unit lights up.

Call screening

Base unit / Handset

While a caller is leaving a message, you can listen to the call through the unit's speaker. To adjust the speaker volume, press **[▲]** or **[▼]** repeatedly. You can answer the call by lifting the corded handset from the base unit or pressing **[📞]** on the handset.

Call screening can be set for each unit. The default setting is “On”.

- 1 **[MENU]#310**
- 2 **[↕]**: Select the desired setting. → **[SAVE]**
- 3 Proceed with the operation for your unit.
Base unit: **[■]** (EXIT)
Handset: **[OFF]**

Greeting message

When the unit answers a call, a greeting message is played to callers.

You can use either:

- your own greeting message
- a pre-recorded greeting message

Recording your greeting message

Greeting messages can be recorded in one of the two following ways:

- for line 1 and line 2 with different greetings (2 minutes max. for each greeting)
- for line 1 and line 2 with the same greeting (2 minutes max.). Select “**Line1&Line2**” in step 2.

Base unit

- 1 **[MENU]#302**
- 2 **[↕]**: Select the desired line(s). → **[SELECT]**
- 3 After the base unit beeps, speak clearly about 20 cm (8 inches) away from the microphone (2 minutes max.).
- 4 Press **[STOP]** to stop recording.
- 5 **[■]** (EXIT)

Using a pre-recorded greeting message

If you erase or do not record your own greeting message, the unit plays a pre-recorded greeting asking callers to leave a message.

Resetting to a pre-recorded greeting message

If you want to use a pre-recorded greeting message once you record your own greeting message, you need to erase your own greeting message.

Base unit

- 1 **[MENU]** **#** **3** **0** **3**
- 2 **[↕]**: Select the desired line(s). → **[SELECT]**
- 3 Press **[ERASE]** while your greeting message is playing.
- 4 **[■]** (EXIT)

Playing back the greeting message

Base unit

- 1 **[MENU]** **#** **3** **0** **3**
- 2 **[↕]**: Select the desired line(s). → **[SELECT]**
- 3 **[■]** (EXIT)

Listening to messages using the base unit

When new messages have been recorded:

- **[▶]** on the base unit flashes.
- “New message” is displayed.

Press **[▶]**.

- If new messages have been recorded, the base unit plays back new messages.
- If there are no new messages, the base unit plays back all messages.

Playing back messages for the desired line(s)

Press **[ANSWER SELECT]** repeatedly to select the desired line(s), then press **[▶]**.

Operating the answering system during playback

Key	Operation
[▲] or [▼]	Adjust the speaker volume
[◀◀]	Repeat message*1
[▶▶]	Skip message
[PAUSE]	Pause message To resume playback, press [▶] .
[■] (STOP)	Stop playback
[ERASE]	Erase currently playing message

*1 If pressed within the first 5 seconds of a message, the previous message is played.

Calling back (Caller ID subscribers only)

If caller information was received for the call, you can call the caller back while listening to a message.

- 1 Press **[EDIT]** during playback.
 - To edit the number before calling back, press **[EDIT]** repeatedly until the phone number is shown in the desired format (page 33).
- 2 Lift the corded handset.
 - The unit automatically uses the line you set in line selection mode (page 14) to call back. When the line selection mode is set to “Auto”, the indicated line (**[L1]** or **[L2]**) is used for the call. If the indicated line is already being used or you want to select the other line, press **[LINE 1]** or **[LINE 2]**, then lift the corded handset.

Erasing all messages

Erasing all messages for both line 1 and line 2

- 1 **[ERASE]**
 - **[LINE1]** and **[LINE2]** are displayed.
- 2 Press **[ERASE]** again.

Erasing all messages for the desired line(s)

Press **[ANSWER SELECT]** repeatedly to select the desired line(s), then press **[ERASE]** 2 times.

Listening to messages using the handset

When new messages have been recorded, “New message” is displayed.

1 To listen to new messages:

[MENU]#[3][2][3]

To listen to all messages:

[MENU]#[3][2][4]

2 When finished, press **[OFF]**.

Note:

- To switch to the receiver, press **[↶]**.

Playing back messages for the desired line(s)

1 **[MENU]** → **[↕]**: “Answering device” → **[SELECT]**

2 Press **[☐☐☐]** repeatedly to select the desired line(s).

3 **[↕]**: “Play new msg.” or “Play all msg.” → **[SELECT]**

4 When finished, press **[OFF]**.

Operating the answering system

[MENU] → **[↕]**: “Answering device” → **[SELECT]** → Press **[☐☐☐]** repeatedly to select the desired line(s) if necessary.

Key	Operation
[▲] or [▼]	Adjust the receiver/speaker volume (during playback)
[1] or [←]	Repeat message (during playback)*1
[2] or [→]	Skip message (during playback)
[3]	Enter the “Settings” menu
[4]	Play new messages
[5]	Play all messages
[PAUSE]	Pause message*2
[9] or [STOP]	Stop playback
[0]	Turn answering system off
[X][4]	Erase currently playing message
[X][5]	Erase all messages
#[1]→[8]*3	Turn answering system on for line 1 only

Key	Operation
#[2]→[8]*3	Turn answering system on for line 2 only
#[0]→[8]*3	Turn answering system on for both line 1 and line 2

*1 If pressed within the first 5 seconds of a message, the previous message is played.

*2 To resume playback:

[↕]: “Playback” → **[SELECT]**

*3 For English voice guidance only:

When you press a line selection number (**#[1]**, **#[2]**, or **#[0]**), the selected line(s) is announced, then press **[8]**.

Calling back (Caller ID subscribers only)

If caller information is received for the call, you can call the caller back while listening to a message.

1 Press **[MENU]** during playback.

2 **[↕]**: “Edit & Call” → **[SELECT]**

- To edit the number before calling back, press **[EDIT]** repeatedly until the phone number is shown in the desired format (page 33).

3 **[↶]**

- The unit automatically uses the line you set in line selection mode (page 14) to call back. When the line selection mode is set to “Auto”, the indicated line (**[L1]** or **[L2]**) is used for the call. If the indicated line is already being used or you want to select the other line, press **[LINE 1]** or **[LINE 2]**.

Erasing all messages

Erasing all messages for both line 1 and line 2

1 **[MENU]#[3][2][5]**

2 **[↕]**: “Yes” → **[SELECT]** → **[OFF]**

Erasing all messages for the desired line(s)

1 **[MENU]** → **[↕]**: “Answering device” → **[SELECT]**

2 Press **[☐☐☐]** repeatedly to select the desired line(s).

3 **[↕]**: “Erase all” → **[SELECT]**

4 **[↕]**: “Yes” → **[SELECT]** → **[OFF]**

Remote operation

Using a touch-tone phone, you can call your phone number from outside and access the unit to listen to messages or change answering system settings. The unit's voice guidance prompts you to press certain dial keys to perform different operations.

Remote access code

A 3-digit remote access code must be entered when operating the answering system remotely. This code prevents unauthorized parties from listening to your messages remotely. The default setting is "111".

Program this setting using either the base unit or one of the handsets.

Important:

- To prevent unauthorized access to this product, we recommend that you regularly change the remote code.

Base unit / Handset

- [MENU]# [3] [0] [6]**
- Enter the desired 3-digit remote access code.
→ **[SAVE]**
- Proceed with the operation for your unit.
Base unit: [■] (EXIT)
Handset: [OFF]

Using the answering system remotely

- Dial your phone number from a touch-tone phone.
- After the greeting message starts, enter your remote access code.
- Follow the voice guidance prompts as necessary or control the unit using remote commands (page 38).
- When finished, hang up.

Voice guidance

- When the English voice guidance is selected**
During remote operation, the unit's voice guidance starts and prompts you to press **[1]** to perform a specific operation, or press **[2]** to listen to more available operations.

- When the Spanish voice guidance is selected**

To start the voice guidance, press **[9]**. The voice guidance announces the available remote commands (page 38).

Note:

- If you do not press any dial keys within 10 seconds after a voice guidance prompt, the unit disconnects your call.

Remote commands

You can press dial keys to access certain answering system functions without waiting for the voice guidance to prompt you.

- Select the desired line(s) while you are accessing the answering system if necessary.
For line 1: **# [1]**
For line 2: **# [2]**
For line 1 and line 2: **# [0]**
- Press the desired dial keys.

Key	Operation
[1]	Repeat message (during playback)*1
[2]	Skip message (during playback)
[4]	Play new messages
[5]	Play all messages
[6]	Play greeting message
# [1] [7]	Record a greeting message for line 1 only
# [2] [7]	Record a greeting message for line 2 only
# [0] [7]	Record a common greeting message for both line 1 and line 2
# [1] [8]	Turn answering system on for line 1 only
# [2] [8]	Turn answering system on for line 2 only
# [0] [8]	Turn answering system on for both line 1 and line 2
[9]	Stop recording Stop playback*2 Start voice guidance*3
[0]	Turn answering system off
[X] [4]	Erase currently playing message
[X] [5]	Erase all messages
[X] [6]	Erase greeting message (during greeting message playback)

Key	Operation
#	End remote operation (or hang up)

- *1 If pressed within the first 5 seconds of a message, the previous message is played.
- *2 For English voice guidance only
- *3 For Spanish voice guidance only

Turning on the answering system remotely

If the answering system is off, you can turn it on remotely.

Important:

- The answering system can be remotely turned on only for the line which you have currently selected in “Turning the answering system on/off”, page 35.
- 1 Dial your phone number from a touch-tone phone.
 - 2 Let the phone ring 15 times.
 - A long beep is heard.
 - 3 Enter your remote access code within 10 seconds after the long beep.
 - The greeting message is played back.
 - You can either hang up, or enter your remote access code again and begin remote operation (page 38).

Note:

- If you want to turn on the answering system for the line which has not been selected in “Turning the answering system on/off”, page 35, enter the desired remote commands, **# 1 8**, **# 2 8**, or **# 0 8**, (page 38) to turn on and access the other line.

Answering system settings

Number of rings before the unit answers a call

You can change the number of times the phone rings “**Ring count**” before the unit answers calls. You can select 2 to 7 rings, or “**To11 saver**”.

The default setting is “**4 rings**”.

“**To11 saver**”: The unit’s answering system answers at the end of the 2nd ring when new messages have been recorded, or at the end of the 4th ring when there are no new messages. If you call your phone from outside to listen to new messages (page 38), you know that there are no new messages when the phone rings for the 3rd time. You can then hang up without being charged for the call.

Program this setting using either the base unit or one of the handsets.

Base unit / Handset

- 1 **[MENU]# 2 1 1**
- 2 **[↕]**: Select the desired setting. → **[SAVE]**
- 3 Proceed with the operation for your unit.
Base unit: [■] (EXIT)
Handset: [OFF]

For voice mail service subscribers

If you subscribe to a flat-rate service package that includes Caller ID, call waiting, voice mail, and unlimited local/regional/long distance calls, please note the following:

- To use the voice mail service provided by your service provider/telephone company rather than the unit’s answering system, turn off the answering system (page 35).
- To use this unit’s answering system rather than the voice mail service provided by your service provider/telephone company, please contact your service provider/telephone company to deactivate your voice mail service.
 If your service provider/telephone company cannot do this:
 - Set this unit’s “**Ring count**” setting so that this unit’s answering system answers calls before the voice mail service of your service provider/telephone company does. It is necessary to check the number of rings

required to activate the voice mail service provided by your service provider/telephone company before changing this setting.

- Change the number of rings of the voice mail service so that the answering system can answer the call first. To do so, contact your service provider/telephone company.

Caller's recording time

You can change the maximum message recording time allowed for each caller. The default setting is "3 min".

Program this setting using either the base unit or one of the handsets.

 **Base unit** /  **Handset**

- 1 **[MENU]** **#** **3** **0** **5**
- 2 **[↓]**: Select the desired setting. → **[SAVE]**
- 3 Proceed with the operation for your unit.
Base unit: **[■]** (EXIT)
Handset: **[OFF]**

Voice mail service

Voice mail is an automatic answering service offered by your service provider/telephone company. After you subscribe to this service, your service provider/telephone company's voice mail system answers calls for you when you are unavailable to answer the phone or when your line is busy. Messages are recorded by your service provider/telephone company, not your telephone. Please contact your service provider/telephone company for details of this service.

Important:

- To use the voice mail service provided by your service provider/telephone company rather than the unit's answering system, turn off the answering system (page 35). For details, see page 39.

Voice Mail message indication

The unit lets you know that you have new voice mail messages by showing "VoiceMail:Line1" and/or "VoiceMail:Line2" on the display. To listen to your voice mail messages, you must dial your service provider/telephone company's voice mail access number.

Note:

- If the base unit or handset still indicates there are new messages even after you have listened to all new messages, turn it off by pressing and holding **[OFF]** on the handset until a beep sounds.
- If your voice mail service uses voice mail tones and the message is over 3 minutes long, the unit may not indicate new messages.

Voice mail (VM) tone detection

Base unit / Handset

Your service provider/telephone company sends special signals (sometimes called "voice mail tones" or "stutter tones") to the unit to let you know you have new voice mail messages. If you hear a series of dial tones followed by a continuous dial tone after you lift the corded handset or press **[📞]** on the handset, you have new voice mail messages. Soon after you hang up a call or after the phone stops ringing, your unit checks the

phone line to see if new voice mail messages have been recorded.

Turn this feature off when:

- You do not subscribe to voice mail service.
- Your service provider/telephone company does not send voice mail tones.
- Your phone is connected to a PBX.

If you are not sure which setting is required, contact your service provider/telephone company.

Turning VM tone detection on/off

The default setting is "On".

Program this setting using either the base unit or one of the handsets.

Base unit / Handset

- 1 **[MENU]** **[#]** **[3]** **[3]** **[2]**
- 2 **[↕]**: Select the desired setting. → **[SAVE]**
- 3 Proceed with the operation for your unit.
Base unit: **[■]** (EXIT)
Handset: **[OFF]**

Intercom

Intercom calls can be made:

- between the base unit and a handset
- between handsets

Note:

- If you receive an outside call while talking on the intercom, you hear an interrupt tone (page 28).
 - To answer the call with the base unit, place the corded handset on the cradle, then lift it again. If the speakerphone is used, press **[☎]** 2 times. You can also answer the call by pressing **[LINE 1]** or **[LINE 2]** after hanging up the intercom.
 - To answer the call with the handset, press **[OFF]**, then press **[☎]**.
- When paging unit(s), the paged unit(s) beeps for 1 minute.

Making an intercom call

Base unit

- 1 Press **[INTERCOM]**.
When 2 or more handsets are registered:
 - To page a specific handset, enter the handset number.
 - To page all handsets, press **[0]** or wait for a few seconds.
 - Lift the corded handset if needed.
 - To stop paging, press **[INTERCOM]**.
- 2 When you finish talking, press **[INTERCOM]** or place the corded handset on the cradle.

Handset

- 1 Press **[INTERCOM]**.
- 2 To page the base unit, press **[0]**.
To page another handset, enter its extension number.
 - To stop paging, press **[OFF]**.
- 3 When you finish talking, press **[OFF]**.

Answering an intercom call

Base unit

- 1 Lift the corded handset or press **[INTERCOM]** to answer the page.
- 2 When you finish talking, place the corded handset on the cradle or press **[INTERCOM]**.

Handset

- 1 Press **[☎]** to answer the page.
- 2 When you finish talking, press **[OFF]**.

Note for base unit and handset:

- The ringer volume for intercom calls follows the higher volume level of the 2 lines (page 27).

Handset locator

You can locate a misplaced handset by paging it.

- 1 **Base unit:** Press **[LOCATOR]**.
 - All registered handsets beep for 1 minute.
- 2 To stop paging:
Base unit: Press **[LOCATOR]**.
Handset: Press **[☎]**, then press **[OFF]**.

Transferring calls

Outside calls can be transferred between 2 people.

Base unit

- 1 During an outside call, press **[INTERCOM]**.
When 2 or more handsets are registered:
 - To page a specific handset, enter the handset number.
 - To page all handsets, press **[0]** or wait for a few seconds.
- 2 Wait for the paged party to answer.
 - If paged party does not answer, press the flashing **[LINE 1]** or **[LINE 2]** to return to the outside call.
- 3 Place the corded handset on the cradle.
 - The outside call is being routed to the handset.

Handset

- 1 During an outside call, press **[INTERCOM]** to put the call on hold.
- 2 To page the base unit, press **[0]**.
To page another handset, enter its extension number.
- 3 Wait for the paged party to answer.
 - If the paged party does not answer, press **[LINE 1]** or **[LINE 2]** that is flashing on the handset to return to the outside call.

- 4 Press **[OFF]**.
- The outside call is being routed to the destination unit.

Answering a transferred call

Base unit

Lift the corded handset or press **[📞]** to answer the page.

Handset

Press **[📞]** to answer the page.

Conference calls

3 people can establish a conference call.

Conference call with 2 outside calls

While you are talking with an outside caller, you can make or answer a 2nd call on the other line, and then combine the calls to establish a conference call.

Base unit

- 1 During an outside call, press **[HOLD]**.
- 2 To answer a 2nd call, press **[LINE 1]** or **[LINE 2]**.
To make a 2nd call, press **[LINE 1]** or **[LINE 2]**, then dial the phone number.
- 3 When the 2nd call is connected, press **[MENU]** → **[↕]**: “Conference” → **[SELECT]**
 - The 2 calls are combined.
 - To hang up only one line, press **[LINE 1]** or **[LINE 2]** for the party with which you want to continue talking.
 - To put both lines on hold, press **[HOLD]**.
To talk with only one caller, press **[LINE 1]** or **[LINE 2]** for the party with which you want to continue talking. To resume both lines, press **[CONF]**.

Handset

- 1 During an outside call, press **[HOLD]** 2 times.
- 2 To answer a 2nd call, press **[LINE 1]** or **[LINE 2]**.
To make a 2nd call, press **[LINE 1]** or **[LINE 2]**, then dial the phone number.

- 3 When the 2nd call is connected, press **[MENU]** → **[↕]**: “Conference” → **[SELECT]**
 - The 2 calls are combined.
 - To hang up only one line, press **[LINE 1]** or **[LINE 2]** for the party with which you want to continue talking.
 - To put both lines on hold, press **[HOLD]**.
To talk with only one caller, press **[LINE 1]** or **[LINE 2]** for the party with which you want to continue talking. To resume both lines, press **[CONF]**.

Conference call with an outside call and an intercom call

While you are talking with an outside caller, one more extension can join the conversation and establish a conference call.

Base unit

- 1 During an outside call, press **[INTERCOM]**.
When 2 or more handsets are registered:
 - To page a specific handset, enter the handset number.
 - To page all handsets, press **[0]** or wait for a few seconds.
- 2 When the paged party answers, press **[CONF]**.
 - The 2 calls are combined.
 - To leave the conference, place the corded handset on the cradle. The other 2 parties can continue the conversation.

Handset

- 1 During an outside call, press **[INTERCOM]** once to put the call on hold.
- 2 To page the base unit, press **[0]**.
To page another handset, enter its extension number.
- 3 When the paged party answers, press **[CONF]**.
 - The 2 calls are combined.
 - To leave the conference, press **[OFF]**. The other 2 parties can continue the conversation.

Note for the base unit and handset:

- The outside call can be put on hold by pressing **[HOLD]**. Only the person who placed the call on hold can resume the full conference by pressing **[CONF]**.

Wall mounting

The base unit can be mounted on a wall by changing the wall mounting adaptor's position.

Note:

- Make sure that the wall and the fixing method are strong enough to support the weight of the unit.

Base unit

- 1 To remove the wall mounting adaptor, push down the release levers (1). Remove the adaptor (2).

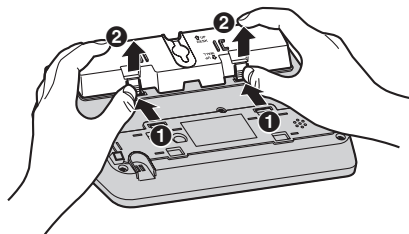

- 2 ① Turn the adaptor so that the words "UP WALL" are facing up.
② Tuck the telephone line cord inside the wall mounting adaptor.
③ Connect the AC adaptor cord and telephone line cord.

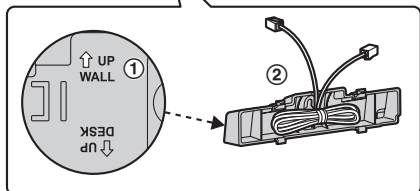
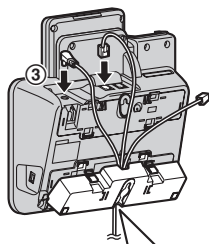

- 3 Insert the lower tabs of the adaptor into the unit's bottom slots (1), then insert by pushing down the levers of the adaptor into the upper slots (2).
 - The words "UP WALL" should be facing up.

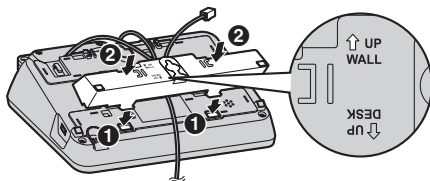

- 4 Mount the unit on a wall then slide down to secure in place.

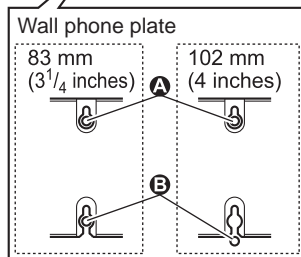
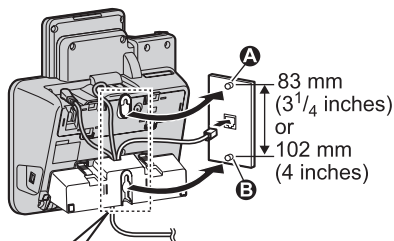

Charger

Drive the screws (not supplied) into the wall.

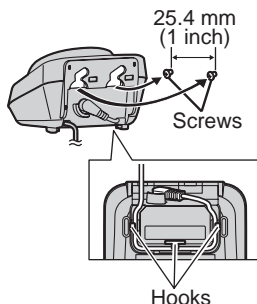

Error messages

Display message	Cause/solution
Busy	<ul style="list-style-type: none"> • The called unit is in use. • Other units are in use and the system is busy. Try again later. • Privacy mode is on for the call you tried to join (page 17). • The handset you are using is too far from the base unit. Move closer and try again.
Check tel line 1 Check tel line 2	<ul style="list-style-type: none"> • The supplied telephone line cord has not been connected yet or not connected properly. Check the connections (page 8). • If you use the unit as a single-line telephone only, erase the message as follows: To erase "Check tel line 1", press [MENU]. → [#][1][8][9] To erase "Check tel line 2", press [MENU]. → [#][1][9][0] When a power failure occurs, the message is displayed again. Erase again as above.
Error!!	<ul style="list-style-type: none"> • Recording was too short. Try again.
Failed	<ul style="list-style-type: none"> • Phonebook copy failed (page 25). Confirm the other unit (the receiver) is in standby mode and try again.
Incomplete	<ul style="list-style-type: none"> • Phonebook copy is incomplete. The receiver's phonebook memory is full. Erase the unwanted phonebook entries (page 24) from the other unit (the receiver) and try again.
Memory full	<ul style="list-style-type: none"> • The phonebook memory is full. Erase unwanted entries (page 24). • Message memory is full. Erase unwanted messages (page 36, 37).
Messages full	<ul style="list-style-type: none"> • Message memory is full. Erase unwanted messages (page 36, 37).
No link to base. Reconnect AC adaptor.	<ul style="list-style-type: none"> • The handset has lost communication with the base unit. Move closer to the base unit and try again. • Unplug the base unit's AC adaptor to reset the unit. Reconnect the adaptor and try again. • The handset's registration may have been canceled. Re-register the handset (page 31).
Use rechargeable battery. You must first subscribe to Caller ID.	<ul style="list-style-type: none"> • A wrong type of battery such as Alkaline or Manganese was inserted. Use only the rechargeable Ni-MH batteries noted on page 4.6. • You must subscribe to a Caller ID service. Once you receive caller information after subscribing to a Caller ID service, this message will not be displayed.

Troubleshooting

If you still have difficulties after following the instructions in this section, disconnect the base unit's AC adaptor, then reconnect the base unit's AC adaptor. Remove the batteries from the handset, and then insert the batteries into the handset again.



General use

Problem	Cause/solution
The handset does not turn on even after installing charged batteries.	<ul style="list-style-type: none"> Place the handset on the charger to turn on the handset.
The unit does not work.	<ul style="list-style-type: none"> Make sure the batteries are installed correctly (page 9). Fully charge the batteries (page 10). Check the connections (page 8). Unplug the base unit's AC adaptor to reset the unit. Reconnect the adaptor and try again. The handset has not been registered to the base unit. Register the handset (page 31).
I cannot hear a dial tone.	<ul style="list-style-type: none"> The base unit's AC adaptor or telephone line cord is not connected. Check the connections. If you are using a splitter to connect the unit, remove the splitter and connect the unit to the wall jack directly. If the unit operates properly, check the splitter. Disconnect the base unit from the telephone line and connect the line to a known working telephone. If the working telephone operates properly, contact our service personnel to have the unit repaired. If the working telephone does not operate properly, contact your service provider/ telephone company.

Programmable settings

Problem	Cause/solution
The display is in a language I cannot read.	<ul style="list-style-type: none"> Change the display language (page 14).
I cannot register a handset to a base unit.	<ul style="list-style-type: none"> The maximum number of handsets (6) is already registered to the base unit. Cancel unused handset registrations from the base unit (page 31).

Battery recharge

Problem	Cause/solution
The handset beeps and/or  flashes.	<ul style="list-style-type: none"> Battery charge is low. Fully charge the batteries (page 10).
I fully charged the batteries, but  still flashes.	<ul style="list-style-type: none"> Clean the battery ends (\oplus, \ominus) and the charge contacts with a dry cloth and charge again. It is time to replace the batteries (page 9).

Making/answering calls, intercom

Problem	Cause/solution
ⓘ is flashing.	<ul style="list-style-type: none"> • The handset is too far from the base unit. Move closer. • The base unit's AC adaptor is not properly connected. Reconnect AC adaptor to the base unit. • The handset is not registered to the base unit. Register it (page 31).
Noise is heard, sound cuts in and out.	<ul style="list-style-type: none"> • You are using the base unit or handset in an area with high electrical interference. Re-position the base unit and use the handset away from sources of interference. • Move closer to the base unit. • If you use a DSL/ADSL service, we recommend connecting a DSL/ADSL filter between the base unit and the telephone line jack. Contact your DSL/ADSL provider for details.
The handset and/or base unit does not ring.	<ul style="list-style-type: none"> • The ringer volume is turned off. Adjust the ringer volume (page 16). • Night mode is turned on. Turn it off (page 30).
I cannot make a call.	<ul style="list-style-type: none"> • The dialing mode may be set incorrectly. Change the setting (page 14). • The handset is too far from the base unit. Move closer and try again.
I cannot make long distance calls.	<ul style="list-style-type: none"> • Make sure that you have long distance service.

Caller ID

Problem	Cause/solution
Caller information is not displayed.	<ul style="list-style-type: none"> • You must subscribe to Caller ID service. Contact your service provider/telephone company for details. • If your unit is connected to any additional telephone equipment such as a Caller ID box or cordless telephone line jack, plug the unit directly into the wall jack. • If you use a DSL/ADSL service, we recommend connecting a DSL/ADSL filter between the base unit and the telephone line jack. Contact your DSL/ADSL provider for details. • The name display service may not be available in some areas. Contact your service provider/telephone company for details. • Other telephone equipment may be interfering with this unit. Disconnect the other equipment and try again.
Caller information is displayed late.	<ul style="list-style-type: none"> • Depending on your service provider/telephone company, the unit may display the caller's information at the 2nd ring or later. • Move closer to the base unit.
The caller list/incoming phone numbers are not edited automatically.	<ul style="list-style-type: none"> • The Caller ID number auto edit feature is turned off. Turn it on and try again (page 28). • You need to call back the edited number to activate Caller ID number auto edit.

Useful Information

Problem	Cause/solution
I cannot dial the phone number edited in the caller list.	<ul style="list-style-type: none">● The phone number you dialed might have been edited incorrectly (for example, the long distance “1” or the area code is missing). Edit the phone number with another pattern (page 33).
Time on the unit has shifted.	<ul style="list-style-type: none">● Incorrect time information from incoming Caller ID changes the time. Set the time adjustment to “Manual1” (off) (page 28).
The 2nd caller’s information is not displayed during an outside call.	<ul style="list-style-type: none">● In order to use Caller ID, call waiting, or Call Waiting Caller ID (CWID), you must first contact your service provider/ telephone company and subscribe to the desired service. After subscribing, you may need to contact your service provider/telephone company again to activate this specific service, even if you already subscribed to both Caller ID and Call Waiting with Caller ID services (CWID).

Answering system

Problem	Cause/solution
The unit does not record new messages.	<ul style="list-style-type: none">● The answering system is not turned on for the line you wish to record messages from. Select the desired line or both lines, then turn the answering system on (page 35).● The message memory is full. Erase unwanted messages (page 36).● The answering system is activated for both lines, and the 1st caller is leaving a voice message. The 2nd caller cannot leave a message, but the caller information will be stored (page 32).● If you subscribe to a voice mail service, messages are recorded by your service provider/telephone company, not your telephone. Change the unit’s number of rings setting or contact your service provider/telephone company (page 39).
I cannot operate the answering system.	<ul style="list-style-type: none">● Someone is using the unit. Wait for the other user to finish.● A caller is leaving a message. Wait for the caller to finish.● The handset is too far from the base unit. Move closer.
I cannot operate the answering system remotely.	<ul style="list-style-type: none">● You are entering the wrong remote access code. If you have forgotten your remote access code, enter the remote access code setting to check your current code (page 38).● Press each key firmly.● The answering system is turned off. Turn it on (page 39).

Telephone Plug-in

Problem	Cause/solution
If the installer program does not start automatically.	<ul style="list-style-type: none"> ● Double click [Setup.exe] in your CD-ROM drive folder to start installing.
A pop-up window (Microsoft Office Outlook contact list) is not displayed when a call is received.	<ul style="list-style-type: none"> ● Caller information indication in the "Telephone Plug-in" setting is set to "Disable". Set it to "Enable" (page 22). ● If more than 5,000 entries are stored in the contact list, pop-up windows may not be displayed. Erase entries from the contact list so that the number of stored entries is 5,000 or less. ● The base unit is in use.
"Invalid phone number" is displayed and I cannot make a call from the Microsoft Outlook contact list.	<ul style="list-style-type: none"> ● If you entered 25 or more digits for the phone number in the toolbar, "Telephone Plug-in" cannot dial the phone number. Enter up to 24 digits for the phone number in the toolbar. ● Entries other than 0 to 9, *, #, p (Pause), f (Flash) are invalid. Enter only valid digits or characters.
I want to update "Telephone Plug-in".	<ul style="list-style-type: none"> ● Once uninstall "Telephone Plug-in", and then re-install the latest version of "Telephone Plug-in" (page 20). Visit our Web site below to download the latest version of "Telephone Plug-in". http://www.panasonic.com/support
The caller information shown on the unit's display (handset and base unit) differs from the information shown on the pop-up window on the computer.	<ul style="list-style-type: none"> ● When calls are received on LINE 1 and LINE 2 at the same time, the caller information shown on the pop-up window which appears at the front may differ from the information shown on the unit's display (handset and base unit). To answer the call that you want to pick up, check the caller information on the unit's display and press the appropriate line key based on that information. ● Depending on the Microsoft Office Outlook settings, an area code is automatically added for 7-digit phone numbers in the pop-up window. Edit the phone number if necessary. ● The phone number shown on the unit's display (handset and base unit) may differ from the information shown in the pop-up window on the computer when: <ul style="list-style-type: none"> – the Caller ID auto edit feature is used to ignore the area code. – the phone number is not stored as 11 digits in the Microsoft Office Outlook contact list.

Liquid damage

Problem	Cause/solution
Liquid or other form of moisture has entered the base unit/handset.	<ul style="list-style-type: none"> ● Disconnect the AC adaptor and telephone line cord from the base unit. Remove the batteries from the handset and leave to dry for at least 3 days. After the base unit/handset are completely dry, reconnect the AC adaptor and telephone line cord. Insert the batteries and charge fully before use. If the unit does not work properly, contact an authorized service center.

Caution:

- To avoid permanent damage, do not use a microwave oven to speed up the drying process.

FCC and other information

This equipment complies with Part 68 of the FCC rules and the requirements adopted by the ACTA. On the bottom of this equipment is a label that contains, among other information, a product identifier in the format US:ACJ-----.

If requested, this number must be provided to the telephone company.

- Registration No.....(found on the bottom of the unit)
- Ringer Equivalence No. (REN).....1.0B (line1 and line2)

A plug and jack used to connect this equipment to the premises wiring and telephone network must comply with the applicable FCC Part 68 rules and requirements adopted by the ACTA. A compliant telephone cord and modular plug is provided with the product. It is designed to be connected to a compatible modular jack that is also compliant.

The REN is used to determine the number of devices that may be connected to a telephone line. Excessive RENs on a telephone line may result in the devices not ringing in response to an incoming call. In most but not all areas, the sum of RENs should not exceed five (5.0). To be certain of the number of devices that may be connected to a line, as determined by the total RENs, contact the local telephone company. For products approved after July 23, 2001, the REN for the product is part of the product identifier that has the format US:AAAEQ##TXXXX. The digits represented by ## are the REN without a decimal point (e.g., 03 is a REN of 0.3).

If this equipment causes harm to the telephone network, the telephone company will notify you in advance that temporary discontinuance of service may be required. But if advance notice isn't practical, the telephone company will notify the customer as soon as possible. Also, you will be advised of your right to file a complaint with the FCC if you believe it is necessary.

The telephone company may make changes in its facilities, equipment, operations or procedures that could affect the operation of the equipment. If this happens the telephone company will provide advance notice in order for you to make necessary modifications to maintain uninterrupted service.

If trouble is experienced with this equipment, for repair or warranty information, please contact a Factory Service Center or other Authorized Servicer. If the equipment is causing harm to the telephone network, the telephone company may request that you disconnect the equipment until the problem is resolved.

Connection to party line service is subject to state tariffs. Contact the state public utility commission, public service commission or corporation commission for information.

If your home has specially wired alarm equipment connected to the telephone line, ensure the installation of this equipment does not disable your alarm equipment. If you have questions about what will disable alarm equipment, consult your telephone company or a qualified installer.

This equipment is hearing aid compatible as defined by the FCC in 47 CFR Section 68.316.

When you hold the phone to your ear, noise might be heard in your Hearing Aid. Some Hearing Aids are not adequately shielded from external RF (radio frequency) energy. If noise occurs, use an optional headset accessory or the speakerphone option (if applicable) when using this phone. Consult with your audiologist or Hearing Aid manufacturer about the availability of Hearing Aids which provide adequate shielding to RF energy commonly emitted by digital devices.

WHEN PROGRAMMING EMERGENCY NUMBERS AND/OR MAKING TEST CALLS TO EMERGENCY NUMBERS:

- 1) Remain on the line and briefly explain to the dispatcher the reason for the call.
- 2) Perform such activities in the off-peak hours, such as early morning or late evenings.

This device complies with Part 15 of the FCC Rules. Operation is subject to the following two conditions: (1) This device may not cause harmful interference, and (2) this device must accept any interference received, including interference that may cause undesired operation. Privacy of communications may not be ensured when using this phone.

CAUTION:

Any changes or modifications not expressly approved by the party responsible for compliance could void the user's authority to operate this device.

NOTE:

This equipment has been tested and found to comply with the limits for a Class B digital device, pursuant to Part 15 of the FCC Rules. These limits are designed to provide reasonable protection against harmful interference in a residential installation. This equipment generates, uses, and can radiate radio

frequency energy and, if not installed and used in accordance with the instructions, may cause harmful interference to radio communications. However, there is no guarantee that interference will not occur in a particular installation. If this equipment does cause harmful interference to radio or television reception, which can be determined by turning the equipment off and on, the user is encouraged to try to correct the interference by one or more of the following measures:

- Reorient or relocate the receiving antenna.
- Increase the separation between the equipment and receiver.
- Connect the equipment into an outlet on a circuit different from that to which the receiver is connected.
- Consult the dealer or an experienced radio/TV technician for help.

Some cordless telephones operate at frequencies that may cause interference to nearby TVs and VCRs. To minimize or prevent such interference, the base of the cordless telephone should not be placed near or on top of a TV or VCR. If interference is experienced, move the cordless telephone further away from the TV or VCR. This will often reduce or eliminate interference.

FCC RF Exposure Warning:

- This product complies with FCC radiation exposure limits set forth for an uncontrolled environment.
- To comply with FCC RF exposure requirements, the base unit must be installed and operated 20 cm (8 inches) or more between the product and all person's body (excluding extremities of hands, wrist and feet).
- This product may not be collocated or operated in conjunction with any other antenna or transmitter.
- The handset may be carried and operated with only the specific provided belt-clip. Other non-tested belt-clips or similar body-worn accessories may not comply and must be avoided.

Responsible party:

Panasonic Corporation of North America
One Panasonic Way, Secaucus, New Jersey 07094
Phone number: 1-800-211-PANA (1-800-211-7262)

FCC Warning:

To ensure compliance with FCC emissions limits, use only the provided USB cable with ferrite core when connecting the unit to a computer.

Notice

- FCC ID can be found inside the battery compartment or on the bottom of the units.

Compliance with TIA-1083 standard:

Telephone handsets identified with this logo have reduced noise and interference when used with T-Coil equipped hearing aids and cochlear implants.



Specifications

- **Standard:**
DECT 6.0 (Digital Enhanced Cordless Telecommunications 6.0)
- **Frequency range:**
1.92 GHz to 1.93 GHz
- **RF transmission power:**
115 mW (max.)
- **Power source:**
120 V AC, 60 Hz
- **Power consumption:**
Base unit:
Standby: Approx. 1.2 W
Maximum: Approx. 2.7 W
Charger:
Standby: Approx. 0.6 W
Maximum: Approx. 3.6 W
- **Interface:**
USB 2.0 Full speed (12 Mbps)
- **Operating conditions:**
0 °C - 40 °C (32 °F - 104 °F), 20 % - 80 % relative air humidity (dry)

Note:

- Design and specifications are subject to change without notice.
- The illustrations in these instructions may vary slightly from the actual product.

Guía Rápida Española

Instalación

Cómo conectar el adaptador para corriente y el auricular alámbrico

- Use solo el adaptador de corriente Panasonic PQLV219 incluido.
- Para sujetar el cable del adaptador de corriente al gancho de la unidad base, debe retirar la base para escritorio/adaptador de instalación en la pared una vez. Consulte la "Connecting the AC adaptor/corded handset" (Cómo conectar el adaptador para corriente y el auricular alámbrico) del manual de instrucciones para obtener detalles.

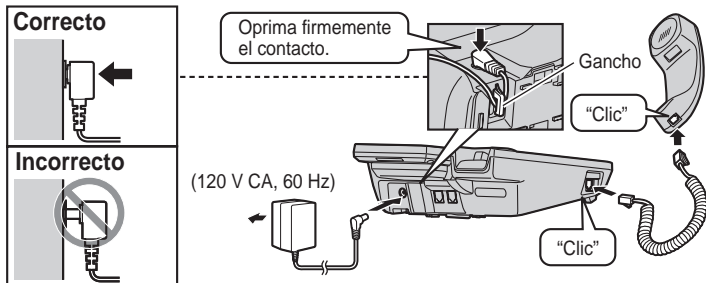

Cómo conectar el cable de la línea telefónica

- Para conectarlo a una toma telefónica para 2 líneas

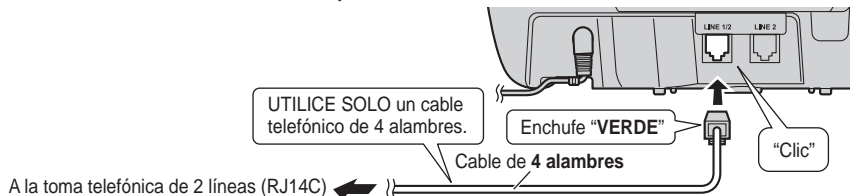

- Para conectarlo a 2 tomas telefónicas de una sola línea

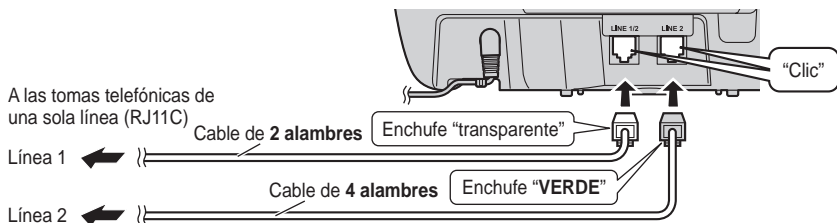

Si está suscrito a un servicio de DSL/ADSL, añada un filtro de DSL/ADSL a la línea telefónica entre la unidad base y la toma de la línea telefónica. Consulte las instrucciones de operación para ver las conexiones.

Instalación

Auricular

- UTILICE SOLO baterías de Ni-MH tamaño AAA (R03).
- NO utilice baterías Alcalinas, de Manganeseo o de Ni-Cd.
- Compruebe que las polaridades son las correctas (+, -).



CARGUE APROXIMADAMENTE DURANTE 7 HORAS

Confirme que aparezca "Cargando".



Cargador

- Use solo el adaptador de corriente Panasonic PQLV219 incluido.

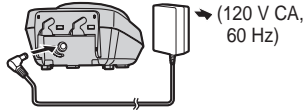

Cómo usar la unidad solo como teléfono de una sola línea

Conecte el cable de la línea telefónica a LINE (LÍNEA) 1/2.

Unidad base/Auricular:

- Para usar solo la línea 1: **[MENU] [#]2[5]0** → **[↕]**: "Linea1"
→ **[GUARD.]** → **[■]** (EXIT)/[OFF]
- Para borrar el mensaje "Rev. Línea tel 2":
[MENU] [#]1[9]0



Use el cable de la línea telefónica con el enchufe "transparente" (cable de 2 alambres).

Sugerencias de operación

Teclas de función

Cada unidad incluye 3 teclas de función. Al oprimir una tecla de función, puede seleccionar la función que aparece directamente encima de ella en la pantalla. **[MENU]**, **[SELEC.]**, **[OK]** y otras funciones adicionales se asignan a las teclas de función. Preste atención a la pantalla para ver qué funciones están asignadas a las teclas de función durante la operación.

Unidad base

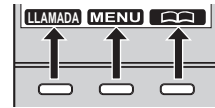

Auricular

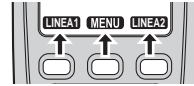

Tecla navegadora

Unidad base:

- **[▲]**, **[▼]**, **[◀◀]** o **[▶▶]**: Navegue por diversas listas y elementos.
- **VOLUME** (**[▲]** o **[▼]**): Ajuste el volumen del receptor o el altavoz mientras habla.
- **[◀◀]/[▶▶]**: Repetir u omitir mensajes durante la reproducción.

Auricular:

- **[▲]**, **[▼]**, **[◀]**, o **[▶]**: Navegue por diversas listas y elementos.
- **↔** (Volumen: **[▲]** o **[▼]**): Ajuste el volumen del receptor o el altavoz mientras habla.

Unidad base

Subir volumen

[▲]

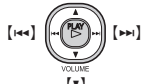

Bajar volumen

[▼]

Auricular

Subir volumen

[▲]

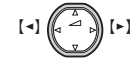

Bajar volumen

[▼]

Cambio de idiomas (predeterminado: "English") (Unidad base/Auricular)

Idioma de la pantalla

1 **[MENU]** **#110** → **[↕]**: "Español" → **[GUARD.]**

2 Continúe con la operación de su unidad.

Unidad base: **[■]** (EXIT)

Auricular: **[OFF]**

Idioma de la guía de voz

1 **[MENU]** **#112** → **[↕]**: "Español" → **[GUARD.]**

2 Continúe con la operación de su unidad.

Unidad base: **[■]** (EXIT)

Auricular: **[OFF]**

Fecha y hora (Unidad base/Auricular)

Programa esta función usando la unidad base o uno de los auriculares.

1 **[MENU]** **#101**

2 Introduzca el día, mes y año actuales.

3 Introduzca la hora y minuto actuales (formato de reloj de 24 horas).

4 **[GUARD.]**

5 Continúe con la operación de su unidad.

Unidad base: **[■]** (EXIT)

Auricular: **[OFF]**

Operaciones básicas

Para hacer y contestar llamadas (Unidad base/Auricular)

Para hacer llamadas	Unidad base: Marque el número telefónico. → Levante el auricular alámbrico u oprima . Auricular: Marque el número telefónico. → /
Para contestar llamadas	Unidad base: Levante el auricular alámbrico u oprima . Auricular: /
Para colgar	Unidad base: Coloque el auricular alámbrico en la base. Cuando utilice el altavoz, oprima . Auricular: [OFF]
Cómo hacer una llamada usando la lista de remarcación	1 [REDIAL] → : Seleccione el número telefónico deseado. 2 Continúe con la operación de su unidad. Unidad base: Levante el auricular alámbrico. Auricular:
Para ajustar el volumen del timbre	1 [MENU] # [1] [6] [0] 2 : Seleccione la línea deseada. → [SELEC.] 3 : Seleccione el volumen deseado. → [GUARD.] 4 Continúe con la operación de su unidad. Unidad base: [■] (EXIT) Auricular: [OFF]

Directorio telefónico (Unidad base/Auricular)

Para añadir entradas	1 Continúe con la operación de su unidad. Unidad base: Auricular: [MENU] # [2] [8] [0] 2 [AÑADIR] 3 Introduzca el nombre de la persona (máx. 16 caracteres). → [OK] 4 Introduzca el número telefónico de la persona (máx. 24 dígitos). → [OK] 5 : Seleccione el grupo deseado. → [SELEC.] 2 veces 6 Continúe con la operación de su unidad. Unidad base: [■] (EXIT) Auricular: [OFF] • Para introducir un nombre, consulte la tabla de caracteres en las instrucciones de operación.
Para hacer llamadas	1 Continúe con la operación de su unidad. Unidad base: Auricular: [MENU] # [2] [8] [0] 2 : Seleccione la entrada deseada. 3 Continúe con la operación de su unidad. Unidad base: Levante el auricular alámbrico. Auricular:

Contestador de llamadas

Contestador encendido (Unidad base)	Oprima [ANSWER SELECT] repetidamente para seleccionar la(s) línea(s) deseada(s). → [ANSWER ON/OFF] • El indicador de ANSWER ON/OFF se ilumina.
Contestador apagado (Unidad base)	[ANSWER ON/OFF] • El indicador de ANSWER ON/OFF se apaga.

Operaciones básicas

Contestador de llamadas

Para escuchar mensajes
(Unidad base/Auricular)

Unidad base: [▶]

Auricular:

Para escuchar mensajes nuevos: [MENU] #323

Para escuchar todos los mensajes: [MENU] #324

Interconexión del teléfono

Las siguientes funciones están disponibles al instalar el "Interconexión del teléfono" que se suministra para Microsoft® Office Outlook® y conectar la unidad base y su computadora con el mini cable USB:

- Puede hacer llamadas desde la lista de contactos de Microsoft Office Outlook a través del altavoz de la unidad.
- La información del que llama se muestra en una ventana desplegable que aparece en su computadora al recibir una llamada.

Cómo hacer llamadas desde "Interconexión del teléfono"

■ Para usuarios de Microsoft Office Outlook 2010

Cómo hacer llamadas desde la lista de contactos de Microsoft Office Outlook 2010

- 1 Encuentre y haga doble clic en el contacto deseado.
- 2 Haga clic [Núm. telef.▼].
- 3 Haga clic en el número telefónico al que desea llamar.
- 4 Haga clic [Llamar línea 1] o [Llamar línea 2] para seleccionar la línea deseada.

Cómo hacer llamadas desde la lista de llamadas

- 1 Haga clic [Lista Llamada▼].
- 2 Haga clic en el número telefónico al que desea llamar.
- 3 Haga clic [Llamar línea 1] o [Llamar línea 2] para seleccionar la línea deseada.

Cómo hacer llamadas al introducir un número telefónico en la barra de herramientas

- 1 Introduzca el número telefónico en la barra de herramientas.
- 2 Haga clic [Llamar línea 1] o [Llamar línea 2] para seleccionar la línea deseada.

Cómo hacer una llamada usando la lista de remarcación

- 1 Haga clic en [▼] que aparecen a la derecha de [Marcar núm.].
- 2 Haga clic en el número telefónico al que desea llamar.
- 3 Haga clic [Llamar línea 1] o [Llamar línea 2] para seleccionar la línea deseada.

■ Para usuarios de Microsoft Office Outlook 2003/2007

Cómo hacer llamadas desde la lista de contactos de Microsoft Office Outlook 2003/2007

- 1 Encuentre y haga doble clic en el contacto deseado.
- 2 Haga clic [Llamar línea 1] o [Llamar línea 2] para seleccionar la línea deseada.
- 3 Haga clic [Núm. telef.▼].
- 4 Haga clic en el número telefónico al que desea llamar.

Cómo hacer llamadas desde la lista de llamadas

- 1 Haga clic [Llamar línea 1] o [Llamar línea 2] para seleccionar la línea deseada.
- 2 Haga clic [Lista Llamada▼].
- 3 Haga clic en el número telefónico al que desea llamar.

Cómo hacer llamadas al introducir un número telefónico en la barra de herramientas

- 1 Haga clic [Llamar línea 1] o [Llamar línea 2] para seleccionar la línea deseada.
- 2 Introduzca el número telefónico en la barra de herramientas.
- 3 Pulse la tecla Intro de su computadora para marcar el número.

Cómo hacer una llamada usando la lista de remarcación

- 1 Haga clic [Llamar línea 1] o [Llamar línea 2] para seleccionar la línea deseada.
- 2 Haga clic en [▼] que aparecen a la derecha de [Marcar núm.].
- 3 Haga clic en el número telefónico al que desea llamar.

Interconexión del teléfono

Cómo colgar una llamada

Cuando termine la llamada, pulse **[⏏]** en la unidad base, o **[Descon. línea 1]** o **[Descon. línea 2]** en la barra de herramientas.

Ventana desplegable "Interconexión del teléfono" para llamadas entrantes

Al recibir una llamada, "Interconexión del teléfono" muestra una ventana desplegable (lista de contactos de Microsoft Office Outlook) en la pantalla de su computadora para informarle que hay una llamada entrante.

Marcas registradas:

- Microsoft y Outlook son marcas registradas o marcas de Microsoft Corporation en los Estados Unidos y otros países.
- Todas las demás marcas comerciales que se identifican en el presente pertenecen a sus respectivos propietarios.

Preguntas frecuentes

Pregunta	Causa y solución
¿Por qué está parpadeando ⏏ ?	<ul style="list-style-type: none"> • El auricular está demasiado lejos de la unidad base. Acérquelo. • El adaptador para corriente de la unidad base no está conectado correctamente. Conecte de nuevo el adaptador para corriente a la unidad base. • El auricular no está registrado en la unidad base. Regístrelo. <ol style="list-style-type: none"> 1 Auricular: [MENU] [#] [1] [3] [0] 2 Unidad base: Oprima y mantenga oprimido [LOCATOR] durante aproximadamente 5 segundos hasta que suene el tono de registro. 3 Auricular: Oprima [OK], y después espere hasta que suene un pitido largo.
¿Cómo se incrementa el nivel de volumen del auricular?	<ul style="list-style-type: none"> • Oprima la tecla de navegación [▲] repetidamente mientras habla.
¿Por qué hay ruido o se corta la conversación?	<ul style="list-style-type: none"> • Trate de reubicar la unidad base de forma que se minimice la distancia al auricular. • Si ocurre el mismo problema aunque el auricular se encuentre enseguida de la unidad base, llame a soporte al cliente de Panasonic al 1-800-211-PANA (1-800-211-7262).
¿Es posible añadir otro auricular accesorio a mi unidad base?	<ul style="list-style-type: none"> • Sí, puede añadir hasta 6 auriculares (incluyendo los que se venden con su propia unidad base) a una sola unidad base. • Para adquirir un auricular accesorio (KX-TGA939), visite http://www.panasonic.com o llame al 1-800-332-5368. Los usuarios TTY (usuarios con impedimentos auditivos o del habla) pueden llamar al 1-866-605-1277.
¿Es posible mantener cargando las baterías todo el tiempo?	<ul style="list-style-type: none"> • Puede dejar el auricular en el cargador el tiempo que lo desee. Esto no daña las baterías.
¿Cómo se contestan las llamadas en espera (segunda llamada)?	<ul style="list-style-type: none"> • Oprima [CALL WAIT] cuando escuche el tono de llamada en espera.

Para obtener más información acerca del registro, visite <http://www.panasonic.com/RegisterYourHandset> (solo en inglés).

Customer services

Customer Services Directory (United States and Puerto Rico)

Obtain Product Information and Operating Assistance; locate your nearest Dealer or Service Center; purchase Parts and Accessories; or make Customer Service and Literature requests by visiting our Web Site at:

<http://www.panasonic.com/help>

or, contact us via the web at:

<http://www.panasonic.com/contactinfo>

You may also contact us directly at: 1-800-211-PANA (1-800-211-7262),
Monday - Friday 9 am to 9 pm; Saturday - Sunday 10 am to 7 pm, EST.

TTY users (hearing or speech impaired users) can call 1-877-833-8855.

Accessory Purchases (United States and Puerto Rico)

Purchase Parts, Accessories and Instruction Books online for all Panasonic Products by visiting our Web Site at:

<http://www.pstc.panasonic.com>

or, send your request by E-mail to:

npcparts@us.panasonic.com

You may also contact us directly at:

1-800-332-5368 (Phone) 1-800-237-9080 (Fax Only)

(Monday - Friday 9 am to 9 pm, EST.)

Panasonic Service and Technology Company

20421 84th Avenue South, Kent, WA 98032

(We Accept Visa, MasterCard, Discover Card, American Express, and Personal Checks.)

TTY users (hearing or speech impaired users) can call 1-866-605-1277.

Warranty (For United States and Puerto Rico)

PANASONIC CORPORATION OF NORTH AMERICA
One Panasonic Way, Secaucus, New Jersey 07094

Panasonic Telephone Products Limited Warranty

Limited Warranty Coverage

If your product does not work properly because of a defect in materials or workmanship, Panasonic Corporation of North America (referred to as "the warrantor") will, for the length of the period indicated on the chart below, which starts with the date of original purchase ("Limited Warranty period"), at its option either (a) repair your product with new or refurbished parts, or (b) replace it with a new or a refurbished product. The decision to repair or replace will be made by the warrantor.

Parts	Labor
One (1) Year	One (1) Year

During the "Labor" Limited Warranty period there will be no charge for labor. During the "Parts" Limited Warranty period, there will be no charge for parts. You must mail-in your product prepaid during the Limited Warranty period. This Limited Warranty excludes both parts and labor for batteries, antennas, and cosmetic parts (cabinet). This Limited Warranty only applies to products purchased and serviced in the United States or Puerto Rico. This Limited Warranty is extended only to the original purchaser and only covers products purchased as new.

Ship-In Service

For assistance in the continental United States and Puerto Rico in obtaining repairs please ship the product prepaid to:

**PSTC (Panasonic) Exchange Center,
4900 George McVay Drive, Suite B Door #12, McAllen, TX 78503**

panacare@us.panasonic.com

When shipping the unit carefully pack in a padded shipping carton, include all accessories, and send it prepaid. Include a letter detailing the complaint, a return address and provide a day time phone number where you can be reached. P.O. Boxes are not acceptable. Keep the tracking number for your records. A copy of valid registered receipt is required under the 1 year parts and labor Limited Warranty.

For Limited Warranty service for headsets if a headset is included with this product please follow instructions above.

IF REPAIR IS NEEDED DURING THE LIMITED WARRANTY PERIOD THE PURCHASER WILL BE REQUIRED TO FURNISH A SALES RECEIPT/PROOF OF PURCHASE INDICATING DATE OF PURCHASE, AMOUNT PAID AND PLACE OF PURCHASE. CUSTOMER WILL BE CHARGED FOR THE REPAIR OF ANY UNIT RECEIVED WITHOUT SUCH PROOF OF PURCHASE.

Limited Warranty Limits And Exclusions

This Limited Warranty ONLY COVERS failures due to defects in materials or workmanship, and DOES NOT COVER normal wear and tear or cosmetic damage. The Limited Warranty ALSO DOES NOT COVER damages which occurred in shipment, or failures which are caused by products not supplied by the warrantor, or failures which result from accidents, misuse, abuse, neglect, bug infestation, mishandling, misapplication, alteration, faulty installation, set-up adjustments, misadjustment of consumer controls, improper maintenance, power line surge, lightning damage, modification, introduction of sand, humidity or liquids, commercial use such as hotel, office, restaurant, or other business or rental use of the product, or service by anyone other than a Factory Service Center or other Authorized Servicer, or damage that is attributable to acts of God.

THERE ARE NO EXPRESS WARRANTIES EXCEPT AS LISTED UNDER "LIMITED WARRANTY COVERAGE". THE WARRANTOR IS NOT LIABLE FOR INCIDENTAL OR CONSEQUENTIAL DAMAGES RESULTING FROM THE USE OF THIS PRODUCT, OR ARISING OUT OF ANY BREACH OF THIS LIMITED WARRANTY. (As examples, this excludes damages for lost time, lost calls or messages, cost of having someone remove or re-install an installed unit if applicable, travel to and from the servicer. The items listed are not exclusive, but are for illustration only.) **ALL EXPRESS AND IMPLIED WARRANTIES, INCLUDING THE WARRANTY OF MERCHANTABILITY, ARE LIMITED TO THE PERIOD OF THE LIMITED WARRANTY.**

Some states do not allow the exclusion or limitation of incidental or consequential damages, or limitations on how long an implied warranty lasts, so the exclusions may not apply to you.

This Limited Warranty gives you specific legal rights and you may also have other rights which vary from state to state. If a problem with this product develops during or after the Limited Warranty period, you may contact your dealer or Service Center. If the problem is not handled to your satisfaction, then write to the warrantor's Consumer Affairs Department at the addresses listed for the warrantor.

PARTS AND SERVICE, WHICH ARE NOT COVERED BY THIS LIMITED WARRANTY, ARE YOUR RESPONSIBILITY.

When you ship the product

- Carefully pack your unit, preferably in the original carton.
- Attach a letter, detailing the symptom.
- Send the unit to PSTC (Panasonic) Exchange Center, prepaid and adequately insured.
- Do not send your unit to Panasonic Corporation of North America listed on the back cover or to executive or regional sales offices. These locations do not repair consumer products.

Index

- # 3-way conference: 17
- A** Additional handset: 31
 - Alarm: 30
 - Answering calls: 16
 - Answering system
 - Call screening: 35
 - Erasing messages: 36, 37, 38
 - Greeting message: 35
 - Listening to messages: 36, 37, 38
 - Number of rings: 39
 - Recording time: 40
 - Remote access code: 38
 - Remote operation: 38
 - Ring count: 39
 - Toll saver: 39
 - Turning on/off: 35, 38, 39
 - Auto talk: 16
- B** Battery: 9, 10
 - Belt clip: 12
- C** Call share: 17
 - Call waiting: 17
 - Call Waiting Caller ID: 17
 - Caller ID number auto edit: 33
 - Caller ID service: 32
 - Caller list: 32
 - Caller list edit: 33
 - Chain dial: 25
 - Check tel line 1: 45
 - Check tel line 2: 9, 45
 - CID (Caller ID): 32
 - Conference calls: 43
 - Control type: 11, 12
 - Customer support: 29
- D** Date and time: 13
 - Dialing mode: 14
 - Direct command code: 26
 - Display
 - Contrast: 28
 - Language: 14
- E** Error messages: 45
- F** Flash: 17, 28
- G** Groups: 23, 32
- H** Handset
 - Deregistration: 31
 - Locator: 42
 - Registration: 31
 - Hold: 16
- I** Intercom: 42
 - Interrupt tone: 28
- K** Key tone: 28
- L** Line mode: 28
 - Line selection mode: 14
- M** Making calls: 15
 - Missed calls: 32
 - Mute: 17
- N** Night mode: 30
- P** Pause: 15
 - Phonebook: 23
 - Phonebook copy: 25
 - Power failure: 10
- R** Redialing: 15
 - Ringer ID: 32
 - Ringer tone: 27, 32
 - Rotary/pulse service: 17
- S** SP-PHONE (Speakerphone): 15
- T** Telephone Plug-in
 - Installation: 19
 - Making calls: 20
 - mini USB cable: 20
 - Pop-up window: 22
 - System requirements: 19
 - Temporary tone dialing: 17
 - Time adjustment: 28
 - Transferring calls: 42
 - Troubleshooting: 46
 - TTY: 58
- V** VM (Voice mail): 41
 - Voice guidance language: 14
 - Voice mail: 39, 41
 - Volume
 - Receiver: 15
 - Ringer (Base unit): 16, 27
 - Ringer (Handset): 16, 27
 - Speaker: 15
- W** Wall mounting: 44

IMPORTANT!

If your product is not working properly. . .

- ① Reconnect AC adaptor to the base unit.
- ② Check if telephone line cord is connected.
- ③ Use rechargeable Ni-MH batteries.
(Alkaline/Manganese/Ni-Cd batteries CANNOT be used.)
- ④ Read **troubleshooting** page in the **Operating Instructions**.



Visit our Web site: <http://www.panasonic.com/help>

- FAQ and troubleshooting hints are available.

For your future reference

We recommend keeping a record of the following information to assist with any repair under warranty.

Serial No.	Date of purchase
(found on the bottom of the base unit)	
Name and address of dealer	

Attach your purchase receipt here.

Panasonic Corporation of North America
One Panasonic Way, Secaucus, New Jersey 07094

© Panasonic System Networks Co., Ltd. 2011

Printed in Malaysia



TG9471

PNQX3179YA TT0611MG1112