

# Panasonic

## Operating Instructions

2.4 GHz Digital Cordless Phone

Model No. **KX-TG3611BX**

Model No. **KX-TG3612BX**



Model shown is KX-TG3611.

**Thank you for purchasing a Panasonic product.**

This unit is compatible with Caller ID. You must subscribe to the appropriate service offered by your service provider/telephone company.

**Charge the batteries for about 7 hours before initial use.**

Please read these operating instructions before using the unit and save them for future reference.



**Table of Contents**

**Introduction**

Model composition . . . . . 3  
 Accessory information . . . . . 3

**Important Information**

For your safety . . . . . 4  
 Important safety instructions . . . . . 5  
 For best performance . . . . . 5  
 Other information . . . . . 6  
 Specifications . . . . . 6

**Getting Started**

Setting up . . . . . 7  
 Note when setting up . . . . . 8  
 Controls . . . . . 9  
 Display . . . . . 10  
 Initial settings . . . . . 10

**Making/Answering Calls**

Making calls . . . . . 11  
 Answering calls . . . . . 11  
 Useful features during a call . . . . . 12  
 Dial lock . . . . . 13

**Phonebook**

Phonebook . . . . . 14

**Programming**

Programmable settings . . . . . 16  
 Special programming . . . . . 19

**Caller ID Service**

Using Caller ID service . . . . . 20  
 Caller list . . . . . 20

**Intercom/Locator**

Intercom . . . . . 23  
 Handset locator . . . . . 23  
 Transferring calls, conference calls . . 23

**Useful Information**

Wall mounting . . . . . 24  
 Error messages . . . . . 25  
 Troubleshooting . . . . . 26

**Index**

Index . . . . . 31

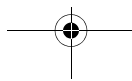
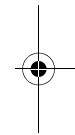
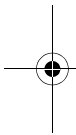

**Introduction**

**Model composition**

Model No.	Base unit	Handset	
	Part No.	Part No.	Quantity
KX-TG3611	KX-TG3611	KX-TGA361	1
KX-TG3612	KX-TG3612	KX-TGA361	2

- The suffix (BX) in the following model numbers will be omitted in these instructions:  
KX-TG3611BX/KX-TG3612BX

**Accessory information**

**Supplied accessories**

No.	Accessory item/Part number	Quantity	
		KX-TG3611	KX-TG3612
①	AC adaptor/PQLV219BX	1	2
②	Telephone line cord	1	1
③	Rechargeable batteries*1/ HHR-65AAAB or N4DHYY00003	2	4
④	Handset cover*2	1	2
⑤	Charger	–	1

\*1 See page 3 for replacement battery information.

\*2 The handset cover comes attached to the handset.

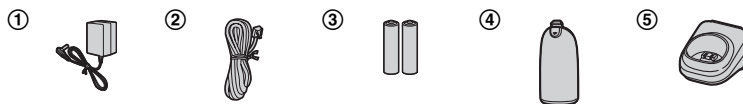

**Additional/replacement accessories**

Please contact your nearest Panasonic dealer for sales information.

Accessory item	Order number
Rechargeable batteries	HHR-4MPT*1
	Battery requirement: – Nickel metal hydride (Ni-MH) type battery – 2 AAA (R03) batteries for each of every handsets

\*1 Replacement batteries may have a different capacity from that of the supplied batteries.

## Important Information

### For your safety

To prevent severe injury and loss of life/property, read this section carefully before using the product to ensure proper and safe operation of your product.

#### WARNING

##### Power connection

- Use only the power source marked on the product.
- Do not overload power outlets and extension cords. This can result in the risk of fire or electric shock.
- Completely insert the AC adaptor/power plug into the power outlet. Failure to do so may cause electric shock and/or excessive heat resulting in a fire.
- Regularly remove any dust, etc. from the AC adaptor/power plug by pulling it from the power outlet, then wiping with a dry cloth. Accumulated dust may cause an insulation defect from moisture, etc. resulting in a fire.
- Unplug the product from power outlets if it emits smoke, an abnormal smell, or makes an unusual noise. These conditions can cause fire or electric shock. Confirm that smoke has stopped emitting and contact an authorized service center.
- Unplug from power outlets and never touch the inside of the product if its casing has been broken open.
- Never touch the plug with wet hands. Danger of electric shock exists.

##### Installation

- To prevent the risk of fire or electrical shock, do not expose the product to rain or any type of moisture.
- Do not place or use this product near automatically controlled devices such as automatic doors and fire alarms. Radio waves emitted from this product may cause such devices to malfunction resulting in an accident.
- Do not allow the AC adaptor or telephone line cord to be excessively pulled, bent or placed under heavy objects.

##### Operating safeguards

- Unplug the product from power outlets before cleaning. Do not use liquid or aerosol cleaners.
- Do not disassemble the product.
- Do not spill liquids (detergents, cleansers, etc.) onto the telephone line cord plug, or allow it to become wet at all. This may cause a fire. If the telephone line cord plug becomes wet, immediately pull it from the telephone wall jack, and do not use.

##### Medical

- Consult the manufacturer of any personal medical devices, such as pacemakers or hearing aids, to determine if they are adequately shielded from external RF (radio frequency) energy. (The product operates in the frequency range of 2.4 GHz to 2.48 GHz, and the RF transmission power is 125 mW (max..))
- Do not use the product in health care facilities if any regulations posted in the area instruct you not to do so. Hospitals or health care facilities may be using equipment that could be sensitive to external RF energy.

#### CAUTION

##### Installation and relocation

- Never install telephone wiring during an electrical storm.
- Never install telephone line jacks in wet locations unless the jack is specifically designed for wet locations.
- Never touch uninsulated telephone wires or terminals unless the telephone line has been disconnected at the network interface.
- Use caution when installing or modifying telephone lines.
- The AC adaptor is used as the main disconnect device. Ensure that the AC outlet is installed near the product and is easily accessible.
- This product is unable to make calls when:
  - the handset batteries need recharging or have failed.
  - there is a power failure.

## Important Information

### Battery

- We recommend using the batteries noted on page 3. **USE ONLY rechargeable Ni-MH batteries AAA (R03) size.**
- Do not mix old and new batteries.
- Do not open or mutilate the batteries. Released electrolyte from the batteries is corrosive and may cause burns or injury to the eyes or skin. The electrolyte is toxic and may be harmful if swallowed.
- Exercise care when handling the batteries. Do not allow conductive materials such as rings, bracelets, or keys to touch the batteries, otherwise a short circuit may cause the batteries and/or the conductive material to overheat and cause burns.
- Charge the batteries provided with or identified for use with this product only, in accordance with the instructions and limitations specified in this manual.
- Only use a compatible base unit (or charger) to charge the batteries. Do not tamper with the base unit (or charger). Failure to follow these instructions may cause the batteries to swell or explode.

### Important safety instructions

When using your product, basic safety precautions should always be followed to reduce the risk of fire, electric shock, and injury to persons, including the following:

1. Do not use this product near water for example, near a bathtub, washbowl, kitchen sink, or laundry tub, in a wet basement or near a swimming pool.
2. Avoid using a telephone (other than a cordless type) during an electrical storm. There may be a remote risk of electric shock from lightning.
3. Do not use the telephone to report a gas leak in the vicinity of the leak.
4. Use only the power cord and batteries indicated in this manual. Do not dispose of batteries in a fire. They may explode. Check with local codes for possible special disposal instructions.

#### SAVE THESE INSTRUCTIONS

### For best performance

#### Base unit location/avoiding noise

The base unit and other compatible Panasonic units use radio waves to communicate with each other.

- For maximum coverage and noise-free communications, place your base unit:
  - at a convenient, high, and central location with no obstructions between the handset and base unit in an indoor environment.
  - away from electronic appliances such as TVs, radios, personal computers, wireless devices, or other phones.
  - facing away from radio frequency transmitters, such as external antennas of mobile phone cell stations. (Avoid putting the base unit on a bay window or near a window.)
- Coverage and voice quality depends on the local environmental conditions.
- If the reception for a base unit location is not satisfactory, move the base unit to another location for better reception.

#### Environment

- Keep the product away from electrical noise generating devices, such as fluorescent lamps and motors.
- The product should be kept free from excessive smoke, dust, high temperature, and vibration.
- The product should not be exposed to direct sunlight.
- Do not place heavy objects on top of the product.
- When you leave the product unused for a long period of time, unplug the product from the power outlet.
- The product should be kept away from heat sources such as heaters, kitchen stoves, etc. It should not be placed in rooms where the temperature is less than 0 °C or greater than 40 °C. Damp basements should also be avoided.
- The maximum calling distance may be shortened when the product is used in the following places: Near obstacles such as hills, tunnels, underground, near metal objects such as wire fences, etc.

### Important Information

- Operating the product near electrical appliances may cause interference. Move away from the electrical appliances.

#### Routine care

- Wipe the outer surface of the product with a soft moist cloth.
- Do not use benzine, thinner, or any abrasive powder.

#### Notice for product disposal, transfer, or return

- This product can store your private/confidential information. To protect your privacy/confidentiality, we recommend that you erase information such as phonebook or caller list entries from the memory before you dispose of, transfer, or return the product.

Maximum: Approx. 3.4 W

#### Charger:

Standby: Approx. 0.1 W  
Maximum: Approx. 2.4 W

#### ■ Operating conditions:

0 °C – 40 °C, 20 % – 80 % relative air humidity (dry)

#### Note:

- Design and specifications are subject to change without notice.
- The illustrations in these instructions may vary slightly from the actual product.

### Other information

#### Information on Disposal in other Countries outside the European Union



These symbols are only valid in the European Union. If you wish to discard these items, please contact your local authorities or dealer and ask for the correct method of disposal.

### Specifications

- **Frequency range:**  
2.4 GHz to 2.48 GHz
- **RF transmission power:**  
125 mW (max.)
- **Power source:**  
220–240 V AC, 50/60 Hz
- **Power consumption:**  
**Base unit:**  
Standby: Approx. 1.2 W

**Getting Started**

**Setting up**

**Connections**

- Use only the supplied Panasonic AC adaptor PQLV219BX.

■ **Base unit**

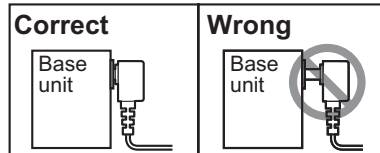
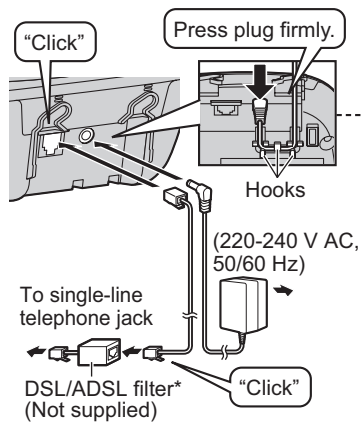

\*For DSL/ADSL service users

■ **Charger**

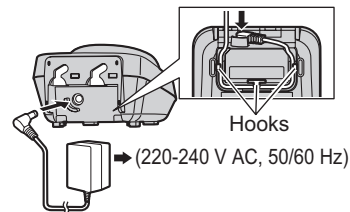

**Battery installation**

- USE ONLY Ni-MH batteries AAA (R03) size.
- Do NOT use Alkaline/Manganese/Ni-Cd batteries.
- Confirm correct polarities (⊕, ⊖).

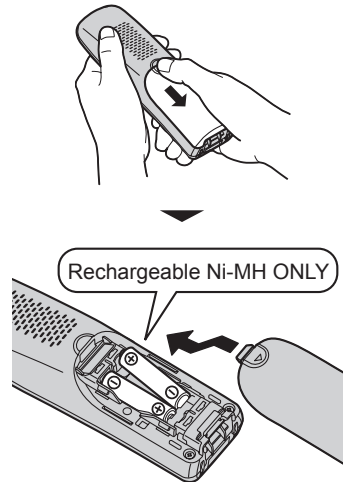

**Battery charge**

Charge for about 7 hours.

- When the batteries are fully charged, the charge indicator goes off.

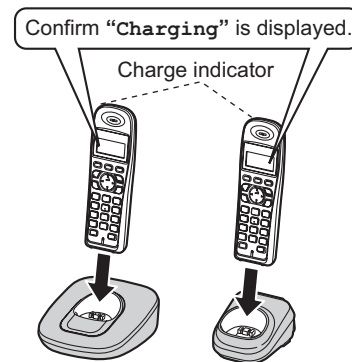

**Getting Started**

**Note when setting up**

**Note for connections**

- The AC adaptor must remain connected at all times. (It is normal for the adaptor to feel warm during use.)
- The AC adaptor should be connected to a vertically oriented or floor-mounted AC outlet. Do not connect the AC adaptor to a ceiling-mounted AC outlet, as the weight of the adaptor may cause it to become disconnected.

**During a power failure**

The unit will not work during a power failure. We recommend connecting a corded-type telephone (without AC adaptor) to the same telephone line or to the same telephone line jack using a T-adaptor.

**Note for battery installation**

- Use the supplied rechargeable batteries. For replacement, we recommend using the Panasonic rechargeable batteries noted on page 3, 5.
- Wipe the battery ends (+, -) with a dry cloth.
- Avoid touching the battery ends (+, -) or the unit contacts.

**Note for battery charge**

- It is normal for the handset to feel warm during charging.
- Clean the charge contacts of the handset, base unit, and charger with a soft and dry cloth once a month. Clean more often if the unit is exposed to grease, dust, or high humidity.

**Battery level**

Icon	Battery level
	High
	Medium
	Low
	Needs charging.
	Empty

**Note:**

- The batteries need to be charged if the handset beeps while you are engaged in a call.

**Panasonic Ni-MH battery performance (supplied batteries)**

Operation	Operating time
In continuous use	5 hours max.* <sup>1</sup>
Not in use (standby)	11 days max.

\*<sup>1</sup> When the clarity booster feature is turned on (page 13): 3 hours max.

**Note:**

- Actual battery performance depends on a combination of how often the handset is in use and how often it is not in use (standby).
- Even after the handset is fully charged, the handset can be left on the base unit or charger without any ill effect on the batteries.
- The battery level may not be displayed correctly after you replace the batteries. In this case, place the handset on the base unit or charger and let it charge for at least 7 hours.



## Controls

### Handset

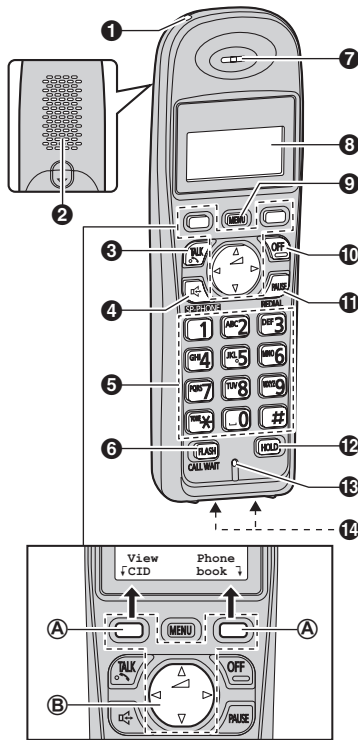

- 1 Charge indicator  
Ringer indicator
- 2 Speaker
- 3 [TALK]
- 4 [SP-PHONE: Speakerphone]
- 5 Dial keypad ([\*]: TONE)
- 6 [FLASH] [CALL WAIT]
- 7 Receiver
- 8 Display
- 9 [MENU]
- 10 [OFF]

11 [PAUSE] [REDIAL]

12 [HOLD]

13 Microphone

14 Charge contacts

#### Control type

##### A Soft keys

The handset features 2 soft keys. By pressing a soft key, you can select the feature shown directly above it on the display.

##### B Navigator key/ (Volume) key

By pressing this key ([▲], [▼], [◀], or [▶]) repeatedly, you can:

- scroll through (up, down, left, or right) various lists or items
- adjust the receiver or speaker volume (up or down) while talking

### Base unit

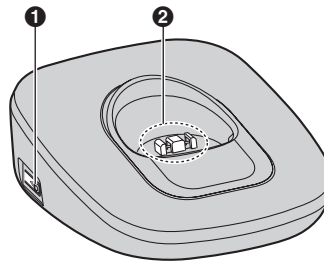

1 [Locator]

2 Charge contacts

## Getting Started

### Display

#### Handset display items

Item	Meaning
	Battery level
[1]	Handset number* <sup>1</sup>
Line in use	Someone is using the line.

\*1 KX-TG3612

### Initial settings

#### Symbol meaning:

Example: [▼]/[▲]: “off”

Press [▼] or [▲] to select the words in quotations.

### Dialing mode

If you cannot make calls, change this setting according to your telephone line service. The default setting is “Tone”.

“Tone”: For tone dial service.

“Pulse”: For rotary/pulse dial service.

- 1 [MENU] → [≡][1][2][0]
- 2 [▼]/[▲]: Select the desired setting.
- 3 [Save] → [OFF]

### Date and time

- 1 [MENU] → [≡][1][0][1]
- 2 Enter the current date, month, and year by selecting 2 digits for each.  
Example: 15 July, 2009  
[1][5] [0][7] [0][9]
- 3 Enter the current hour and minute (12-hour clock format) by selecting 2 digits for each.  
Example: 9:30  
[0][9] [3][0]
- 4 [AM/PM]: Select “AM” or “PM”.
- 5 [Save] → [OFF]

#### Note:

- To correct a digit, press [▲], [▼], [←], or [→] to move the cursor to the digit, then make the correction.
- The date and time may be incorrect after a power failure. In this case, set the date and time again.

## Making/Answering Calls

### 3 [Erase] → [Yes] → [OFF]

### Making calls

- 1 Lift the handset and dial the phone number.
  - To correct a digit, press **[Clear]**.
- 2 Press **[↶]** or **[Call]**.
- 3 When you finish talking, press **[OFF]** or place the handset on the base unit or charger.

### Using the speakerphone

- 1 Dial the phone number and press **[☎]**.
  - Speak alternately with the other party.
- 2 When you finish talking, press **[OFF]**.

#### Note:

- For best performance, use the speakerphone in a quiet environment.
- To switch back to the receiver, press **[↶]**.

### Adjusting the receiver or speaker volume

Press **[▲]** or **[▼]** repeatedly while talking.

### Making a call using the redial list

The last 5 phone numbers dialed are stored in the redial list (each 48 digits max.).

- 1 **[REDIAL]**
- 2 **[▼]/[▲]**: Select the desired phone number.
- 3 **[↶]**

### Erasing a number in the redial list

- 1 **[REDIAL]**
- 2 **[▼]/[▲]**: Select the desired phone number.

### Pause (for PBX/long distance service users)

A pause is sometimes required when making calls using a PBX or long distance service. When storing a calling card access number and/or PIN in the phonebook, a pause is also needed (page 15).

**Example:** If you need to dial the line access number "9" when making outside calls with a PBX:

- 1 **[9] → [PAUSE]**
- 2 Dial the phone number. → **[↶]**

#### Note:

- A 3.5 second pause is inserted each time **[PAUSE]** is pressed. Repeat as needed to create longer pauses.

### Answering calls

When a call is being received, the ringer indicator flashes rapidly.

- 1 Lift the handset and press **[↶]** or **[☎]** when the unit rings.
  - You can also answer the call by pressing any dial key from **[0]** to **[9]**, **[\*]**, or **[#]**. (**Any key answer feature**)
- 2 When you finish talking, press **[OFF]** or place the handset on the base unit or charger.

### Auto talk

You can answer calls simply by lifting the handset off the base unit or charger. You do not need to press **[↶]**. To turn this feature on, see page 17.

## Making/Answering Calls

### Adjusting the handset ringer volume

Press [**▲**] or [**▼**] repeatedly to select the desired volume while the handset is ringing for an incoming call.

#### Note:

- You can also program the handset ringer volume beforehand (page 17).

### Temporary handset ringer off

While the handset is ringing for a call, you can turn the ringer off temporarily by pressing [**OFF**].

## Useful features during a call

### Hold

This feature allows you to put an outside call on hold.

- Proceed with the operation for your model.
  - **KX-TG3611**  
Press [**HOLD**] during an outside call.
  - **KX-TG3612**  
Press [**HOLD**] 2 times during an outside call.
- To release hold, press [**↶**].
  - Another handset user can take the call by pressing [**↶**]. (KX-TG3612)

#### Note:

- If a call is kept on hold for more than 9 minutes, an alarm tone starts to sound and the ringer indicator on the handset flashes rapidly. After 1 additional minute on hold, the call is disconnected.
- If another phone is connected to the same line (page 8), you can also take the call by lifting its handset.

### Mute

While mute is turned on, you can hear the other party, but the other party cannot hear you.

- Press [**Mute**] during an outside call.
  - [**Mute**] flashes.
- To return to the conversation, press [**Mute**] again.

#### Note:

- [**Mute**] is a soft key visible on the handset display during a call.

### Flash

[**FLASH**] allows you to use the special features of your host PBX such as transferring an extension call, or accessing optional telephone services.

#### Note:

- To change the flash time, see page 17.

## For call waiting or Call Waiting Caller ID service users

To use call waiting, you must first subscribe to the call waiting service of your service provider/telephone company.

This feature allows you to receive calls while you are already talking on the phone. If you receive a call while on the phone, you will hear a call waiting tone.

**If you subscribe to both Caller ID and Call Waiting with Caller ID services**, the 2nd caller's information is displayed after you hear the call waiting tone on the handset.

- Press [**CALL WAIT**] to answer the 2nd call.
- To switch between calls, press [**CALL WAIT**].

## Making/Answering Calls

### Note:

- Please contact your service provider/telephone company for details and availability of this service in your area.

### Temporary tone dialing (for rotary/pulse service users)

You can temporarily switch the dialing mode to tone when you need to access touch-tone services (for example, answering services, telephone banking services, etc.).

Press **[\*]** (TONE) before entering access numbers which require tone dialing.

### Handset clarity booster

This feature can improve sound clarity when the handset is used in an area where there may be interference. During an outside call, this feature is turned on automatically when necessary.

- When this feature is turned on, "BOOST" flashes.
- While this feature is turned on, the battery operating time is shortened (page 8).

### Call share

**Available for:**  
KX-TG3612

This feature allows you to join an existing outside call.

To join the conversation, press **[⏪]** when the other handset is on an outside call.

### Dial lock

This feature prohibits making outside calls. The default setting is OFF.

#### Important:

- When dial lock is turned on, only phone numbers stored in the phonebook as emergency numbers (numbers stored with a # at the beginning of the name) can be dialed using the phonebook (page 14). We recommend storing emergency numbers in the phonebook before using this feature.
- When dial lock is turned on, you cannot store, edit, or erase entries in the phonebook.

#### To turn dial lock on

- 1 **[MENU]** → **[#][2][5][1]**
- 2 Enter a 4-digit password.
  - This password is required when turning dial lock off. We recommend writing the password down.
- 3 **[Save]** → **[Yes]** → **[OFF]**

#### Note:

- If dial lock is turned on, the handset displays "Dial lock".

#### To turn dial lock off

- 1 **[MENU]** → **[#][2][5][1]**
- 2 Enter the same password that was entered when dial lock was turned on.
- 3 **[Save]** → **[Yes]** → **[OFF]**

#### Note:

- If you forget the password, see page 30.

**Phonebook**

**Phonebook**

The phonebook allows you to make calls without having to dial manually. You can add 50 names and phone numbers to the phonebook.

**Important:**

- KX-TG3612: If you add entries on one handset, the entries can be shared on another handset. Only 1 person can access the phonebook at a time.

**Adding entries**

- 1 **[Phonebook]**
- 2 **[Add]**
- 3 Enter the party's name (16 characters max.). → **[Next]**
- 4 Enter the party's phone number (32 digits max.). → **[Next]** → **[Save]**
  - To add other entries, repeat from step 2.
- 5 **[OFF]**

**Note:**

- Caller ID subscribers can use ringer ID feature (page 20).

**To store emergency numbers**

Emergency numbers are numbers stored in the phonebook that can be dialed using the phonebook even when dial lock is turned on (page 13). To store a number as an emergency number, add # at the beginning of the name (see "Adding entries", page 14).

**Character table for entering names**

Key	Character
[1]	& ' ( ) , - . / 1
[2]	a b c A B C 2
[3]	d e f D E F 3
[4]	g h i G H I 4

Key	Character
[5]	j k l J K L 5
[6]	m n o M N O 6
[7]	p q r s P Q R S 7
[8]	t u v T U V 8
[9]	w x y z W X Y Z 9
[0]	Space 0
[*]	*
[#]	#

- To enter another character that is located on the same dial key, first press **[▶]** to move the cursor to the next space.

**Correcting a mistake**

Press **[◀]** or **[▶]** to move the cursor to the character or number you want to erase, then press **[Clear]**. Enter the appropriate character or number.

- Press and hold **[Clear]** to erase all characters or numbers.

**Finding and calling a phonebook entry**

**Scrolling through all entries**

- 1 **[Phonebook]** → **[Search]**
- 2 **[v]/[▲]**: Select the desired entry.
- 3 **[↶]**

**Searching by first character (alphabetically)**

- 1 **[Phonebook]** → **[Search]**
- 2 Press the dial key (**[0]** – **[9]**, **[\*]**, or **[#]**) which contains the character you are searching for (page 14).
  - Press the same dial key repeatedly to display the first entry corresponding to each character located on that dial key.

## Phonebook

- If there is no entry corresponding to the character you selected, the next entry is displayed.

**3** **[▼]/[▲]**: Scroll through the phonebook if necessary.

**4** **[↶]**

### Editing entries

**1** Find the desired entry (page 14).  
→ **[Option]**

**2** **[▼]/[▲]**: "Edit" → **[Select]**

**3** Edit the name if necessary (16 characters max.; page 14). → **[Next]**

**4** Edit the phone number if necessary (32 digits max.). → **[Next]** → **[Save]** → **[OFF]**

### Erasing entries

**1** Find the desired entry (page 14).

**2** **[Erase]** → **[Yes]** → **[OFF]**

### Chain dial

This feature allows you to dial phone numbers in the phonebook while you are on a call. This feature can be used, for example, to dial a calling card access number or bank account PIN that you have stored in the phonebook, without having to dial manually.

**1** During an outside call, press **[MENU]**.

- Instead of pressing **[MENU]**, you can also press **[Ph.book]** if it is shown on the display.

**2** **[▼]/[▲]**: Select the desired entry.

**3** Press **[Call]** to dial the number.

#### Note:

- When storing a calling card access number and your PIN in the phonebook as one phonebook entry,

press **[PAUSE]** to add pauses after the number and PIN as necessary (page 11).

- If you have rotary/pulse service, you need to press **[\*]** (TONE) before pressing **[MENU]** in step 1 to change the dialing mode temporarily to tone. When adding entries to the phonebook, we recommend adding **[\*]** (TONE) to the beginning of phone numbers you wish to chain dial (page 14).

## Programming

### Programmable settings

You can customize the unit by programming the following features using the handset. To access the features, there are 2 methods:

- scrolling through the display menus (page 16)
- using the direct commands (page 17)
- Direct command is the main method used in these operating instructions.

#### Programming by scrolling through the display menus

- 1 **[MENU]**
- 2 Press **[▼]** or **[▲]** to select the desired main menu. → **[Select]**
- 3 Press **[▼]** or **[▲]** to select the desired item in sub-menu 1. → **[Select]**
  - In some cases, you may need to select from sub-menu 2. → **[Select]**
- 4 Press **[▼]** or **[▲]** to select the desired setting. → **[Save]**
  - This step may vary depending on the feature being programmed.
  - To exit the operation, press **[OFF]**.

**Note:**

- See page 17 for the default settings.

Main menu	Sub-menu 1	Sub-menu 2	Page	
Night mode	On/Off	–	19	
	Start/End	–	19	
Ringer setting	Ringer volume	–	–	
	Ringer tone	–	–	
Set date & time	Date and time <sup>*1</sup>	–	10	
	Alarm	–	19	
	Time adjustment <sup>*1</sup>	–	–	
Dial lock <sup>*1</sup>	–	–	13	
Initial setting	LCD contrast	–	–	
	Key tone	–	–	
	Auto talk	–	11	
	Set area code <sup>*1</sup>	–	21	
	Set tel line	Set dial mode <sup>*1</sup>	–	10
		Set flash time <sup>*1</sup>	–	12
		Set line mode <sup>*1</sup>	–	–
	Registration	HS registration	–	29
Deregistration		–	29	



**Programming**

\*1 If you program these settings using one of the handsets, you do not need to program the same item using another handset. (KX-TG3612)

**Programming using the direct commands**

- 1 **[MENU]** → **[#]**
- 2 Enter the desired feature code.
- 3 Enter the desired setting code. → **[Save]**
  - This step may vary depending on the feature being programmed.
  - To exit the operation, press **[OFF]**.

**Note:**

- In the following table, < > indicates the default settings.

Feature	Feature code	Setting code	System setting*1	Page
Alarm	[7][2][0]	[1]: Once [2]: Daily [0]: <Off>	–	19
Auto talk*2	[2][0][0]	[1]: On [0]: <Off>	–	11
Date and time	[1][0][1]	–	●	10
Deregistration	[1][3][1]	–	–	29
Dial lock	[2][5][1]	–	●	13
HS registration (Handset registration)	[1][3][0]	–	–	29
Key tone*3	[1][6][5]	[1]: <On> [0]: Off	–	–
LCD contrast (Display contrast)	[1][4][5]	[1]–[6]: Level 1–6 <3>	–	–
Night mode (On/Off)	[2][3][8]	[1]: On [0]: <Off>	–	19
Night mode (Start/End)	[2][3][7]	<11:00 PM/06:00 AM>	–	19
Ringer tone*4 (Handset)	[1][6][1]	[1]–[3]: Tone <1>–3 [4]–[7]: Melody 1–4	–	–
Ringer volume*5 (Handset)	[1][6][0]	[1]: Low [2]: Medium [3]: <High> [0]: Off	–	–
Set area code	[2][5][5]	–	●	21
Set dial mode	[1][2][0]	[1]: Pulse [2]: <Tone>	●	10
Set flash time*6	[1][2][1]	[1]: <700ms> [2]: 600ms [3]: 400ms [4]: 300ms [5]: 250ms [6]: 110ms [7]: 100ms [8]: 90ms	●	12

### Programming

Feature	Feature code	Setting code	System setting <sup>*1</sup>	Page
Set line mode <sup>*7</sup>	[1][2][2]	[1]: A [2]: <B>	●	–
Time adjustment <sup>*8</sup> (Caller ID subscribers only)	[2][2][6]	[1]: Caller ID [auto] [0]: <Manual>	●	–

\*1 If “System setting” column is checked, you do not need to program the same item using another handset. (KX-TG3612)

\*2 If you subscribe to a Caller ID service and want to view the caller’s information after lifting up the handset to answer a call, turn off this feature.

\*3 Turn this feature off if you prefer not to hear key tones while you are dialing or pressing any keys, including confirmation tones and error tones.

\*4 If you select one of the melody ringer tones, the ringer tone continues to play for several seconds even if the caller has already hung up. You may either hear a dial tone or no one on the line when you answer the call.

\*5 When the ringer volume is turned off, “**Ringer off**” is displayed and the handset does not ring for outside calls.

However even when the ringer volume is set to off, the handset rings at the low level for alarm (page 19), and intercom calls, and paging (page 23).

\*6 The flash time depends on your telephone exchange or host PBX. Contact your PBX supplier if necessary.

\*7 Generally, the line mode setting should not be adjusted. If “**Line in use**” is not displayed when another phone connected to the same line is in use, you need to change the line mode to “**A**”.

\*8 If the Caller ID time and date display service is available in your area, this feature allows the unit to automatically adjust the date and time setting when caller information is received. To use this feature, set the date and time first.

**Programming**

**Special programming**

**Night mode**

Night mode allows you to select a period of time during which the handset will not ring for outside calls. This feature is useful for time periods when you do not want to be disturbed, for example, while sleeping. Night mode can be set for each handset.

**Important:**

- Set the date and time beforehand (page 10).
- If you have set the alarm, the alarm sounds even if the night mode is turned on.

**Setting the start and end time**

- 1 **[MENU]** → **[\*][2][3][7]**
- 2 Enter the desired hour and minute you wish to start this feature.
- 3 **[AM/PM]**: Select “**AM**” or “**PM**”. → **[v]**
- 4 Enter the desired hour and minute you wish to end this feature.
- 5 **[AM/PM]**: Select “**AM**” or “**PM**”.
- 6 **[Save]** → **[OFF]**

**Note:**

- To correct a digit, press **[▲]**, **[v]**, **[◀]**, or **[▶]** to move the cursor to the digit, then make the correction.

**Turning night mode on/off**

- 1 **[MENU]** → **[\*][2][3][8]**
- 2 **[v]/[▲]**: Select “**on**” or “**off**”. → **[Save]** → **[OFF]**

**Note:**

- When the night mode is turned on, “**Night mode**” is displayed during the selected period.

**Alarm**

You can set one of 2 different alarm options (once or daily) at a time for each handset. An alarm sounds at the set time for 3 minutes.

You can choose an alarm sound from 3 tones and 4 melodies.

**Important:**

- Set the date and time beforehand (page 10).

- 1 **[MENU]** → **[\*][7][2][0]**
- 2 **[v]/[▲]**: Select the desired alarm option. → **[Select]**

<b>off</b>	Turns alarm off. Go to step 5.
<b>Once</b>	An alarm sounds once at the set time. Enter the desired date, month, and year.
<b>Daily</b>	An alarm sounds daily at the set time.

- 3 Set the desired time. → **[OK]**
- 4 **[v]/[▲]**: Select the desired alarm tone. → **[Save]**
  - We recommend selecting a different one for outside calls.

**5 [OFF]**

**Note:**

- To stop the alarm, press any dial key or place the handset on the base unit or charger.
- When the handset is in use, the alarm will not sound until the handset is in standby mode.
- If you select “**Once**”, the setting changes to “**off**” after the alarm sounds.

## Caller ID Service

### Using Caller ID service

#### Important:

- This unit is Caller ID compatible. To use Caller ID features, you must subscribe to a Caller ID service. Contact your service provider/telephone company for details.

#### Caller ID features

When an outside call is being received, the caller's phone number is displayed. Caller information for the last 50 callers is logged in the caller list from the most recent call to the oldest.

- If the unit cannot receive caller information, the following is displayed:
  - “**Out of area**”: The caller dials from an area which does not provide a Caller ID service.
  - “**Private caller**”: The caller requests not to send caller information.
- If the unit is connected to a PBX system, caller information may not be properly received. Contact your PBX supplier.
- If the name display service is available in your area, the display shows caller names. For further information, please contact your service provider/telephone company.

#### Missed calls

If a call is not answered, the unit treats it as a missed call. The display shows “**Missed call**”. This lets you know if you should view the caller list to see who called while you were away.

#### Phonebook name display

When caller information is received and it matches a phone number stored in the phonebook, the stored name in the

phonebook is displayed and logged in the caller list.

### Ringer ID

This feature can help you identify who is calling by using different ringers for different callers stored in the phonebook. You can assign a different ringer to each phonebook entry. When a call is received from a caller stored in the phonebook, the assigned ringer rings after the caller information is displayed. If you select “**No Ringer ID**” (default), the handset uses the ringer tone you selected on page 17 when a call is received from that caller.

- The ringer may be changed after the 2nd ring.

- 1 Find the desired entry (page 14).  
→ **[Option]**
- 2 **[▼]/[▲]**: “**Ringer ID**” → **[Select]**
- 3 **[▼]/[▲]**: Select the desired setting.
- 4 **[Save]** → **[OFF]**

#### Note:

- When you assign the ringer ID to an entry in the phonebook using one handset, it is applied for another handset. (KX-TG3612)

### Caller list

#### Important:

- Only 1 person can access the caller list at a time. (KX-TG3612)
- Make sure the unit's date and time setting is correct (page 10).

### Viewing the caller list and calling back

- 1 **[View CID]**

## Caller ID Service

- 2 Press [**▼**] to search from the most recent call, or [**▲**] to search from the oldest call.
- 3 To call back, press [**↶**].  
To exit, press [**OFF**].

### Note:

- If the entry has already been viewed or answered:
  - “✓” is displayed. (KX-TG3611)
  - “✓” is displayed, even if it was viewed or answered using another handset. (KX-TG3612)
- If an arrow “→” is displayed after the number, the whole phone number is not shown. Press [**▶**] to see the remaining numbers. To return to the previous display, press [**◀**].

### Storing your area code

We recommend storing your area code before using Caller ID (page 20). Calls from the same area will be recorded in the caller list without the area code. You do not have to remove it before calling back the caller or storing in the phonebook.

- 1 [**MENU**] → [**Ⓜ**][2][5][5]
- 2 Enter your area code (8 digits max.).
  - To correct a digit, press [**◀**] or [**▶**] to move the cursor, then press [**Clear**]. Enter the correct number.
- 3 [**Save**] → [**OFF**]

### To erase your area code

- 1 [**MENU**] → [**Ⓜ**][2][5][5]
- 2 Press and hold [**Clear**] until all digits erased. → [**Save**] → [**OFF**]

### Editing a caller's phone number before calling back

You can edit a phone number in the caller list.

- 1 [**View CID**]
- 2 [**▼**]/[**▲**]: Select the desired entry.  
→ [**Select**] → [**Edit**]
- 3 Add or erase digits to the beginning of the number as necessary.
  - To add a digit, press the desired dial key.
  - To erase a digit, press [**Clear**] or [**Ⓜ**].
- 4 [**↶**]

### Note:

- The edited phone number is not saved in the caller list.

### Erasing selected caller information

- 1 [**View CID**]
- 2 [**▼**]/[**▲**]: Select the desired entry.
- 3 [**Erase**] → [**Yes**] → [**OFF**]

### Erasing all caller information

- 1 [**View CID**]
- 2 [**All erase**] → [**Yes**]

### Storing caller information to the phonebook

- 1 [**View CID**]
- 2 [**▼**]/[**▲**]: Select the desired entry.  
→ [**Select**]
  - To edit the number, press [**Edit**], then edit the number (see step 3 on “Editing a caller's phone number before calling back”, page 21).
- 3 [**Save**]



### **Caller ID Service**

- If there is name information for the caller, go to step 5.
- 4** Enter the name (16 characters max.; page 14). → **[Next]** → **[Save]**
  - 5** **[OFF]**

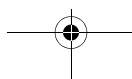
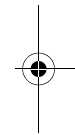
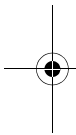

*Intercom/Locator*

## Intercom

**Available for:**  
KX-TG3612

Intercom calls can be made between handsets.

**Note:**

- If you receive an outside call while talking on the intercom, you hear 2 tones.  
To answer the call with the handset, press **[OFF]**, then press **[↶]**.
- When paging a unit for an intercom call, the paged unit beeps for 1 minute.

### Making an intercom call

- 1 **[HOLD]**
  - To stop paging, press **[OFF]**.
- 2 When you finish talking, press **[OFF]**.

### Answering an intercom call

- 1 Press **[↶]** to answer the page.
- 2 When you finish talking, press **[OFF]**.

## Handset locator

You can locate a misplaced handset by pressing **[••]** (Locator) on the base unit. To stop paging, press it again or **[OFF]** on the handset.

## Transferring calls, conference calls

**Available for:**  
KX-TG3612

Outside calls can be transferred between 2 handsets. 2 handsets can have a conference call with an outside party.

- 1 During an outside call, press **[HOLD]** to put the call on hold.
- 2 Press the right soft key.
- 3 Wait for the paged party to answer.
  - If the paged party does not answer, press **[↶]** to return to the outside call.

- 4 **To complete the transfer:**  
Press **[OFF]**.
  - The outside call is being routed to the destination unit.

**To establish a conference call:**  
Press **[Conf]**.

- To leave the conference, press **[OFF]**. The other parties can continue the conversation.
- To put the outside call on hold, press **[HOLD]**. To resume the conference, press **[Conf]**.

### Answering a transferred call

Press **[↶]** to answer the page.

**Note:**

- After the paging party disconnects, you can talk to the outside caller.

### Useful Information

## Wall mounting

### Base unit

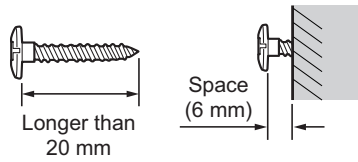
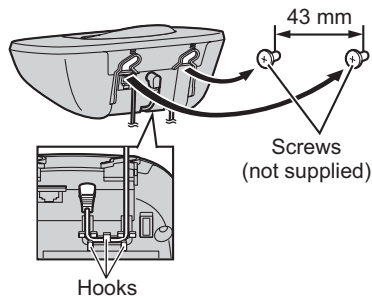

### Charger

Available for:  
KX-TG3612

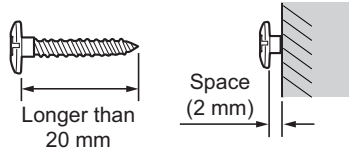
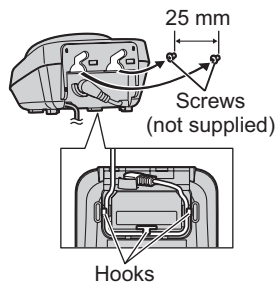



**Useful Information****Error messages**

If the unit detects a problem, one of the following messages is shown on the display.

Display message	Cause/solution
<b>Busy</b>  or  <b>System is busy. Please try again later.</b>	<ul style="list-style-type: none"> <li>● The called handset is in use.*<sup>1</sup></li> <li>● Another handset is in use and the system is busy. Try again later.*<sup>1</sup></li> <li>● The handset you are using is too far from the base unit. Move closer and try again.</li> <li>● The handset's registration may have been canceled. Re-register the handset (page 29).</li> </ul>
<b>Check tel line</b>	<ul style="list-style-type: none"> <li>● The supplied telephone line cord has not been connected yet or not connected properly. Check the connections (page 7).</li> </ul>
<b>Dial locked</b>	<ul style="list-style-type: none"> <li>● Dial lock is turned on. To turn it off, see page 13.</li> </ul>
<b>Don't use this battery.</b>	<ul style="list-style-type: none"> <li>● A wrong type of battery such as Alkaline or Manganese was inserted. Use only the rechargeable Ni-MH batteries noted on page 3, 5.</li> </ul>
<b>Error!!</b>	<ul style="list-style-type: none"> <li>● The handset's registration has failed. Move the handset and base unit away from all electrical appliances and try again.</li> <li>● The entered password was wrong in programming dial lock. Enter the correct password.</li> </ul>
<b>Invalid</b>	<ul style="list-style-type: none"> <li>● There is no handset registered to the base unit matching the handset number you entered.*<sup>1</sup></li> <li>● The handset's registration may have been canceled. Re-register the handset (page 29).</li> </ul>
<b>No link to base. Reconnect AC adaptor.</b>	<ul style="list-style-type: none"> <li>● The handset has lost communication with the base unit. Move closer to the base unit and try again.</li> <li>● Unplug the base unit's AC adaptor to reset the unit. Reconnect the adaptor and try again.</li> <li>● The handset's registration may have been canceled. Re-register the handset (page 29).</li> </ul>

\*1 KX-TG3612

## Useful Information

### Troubleshooting

If you still have difficulties after following the instructions in this section, disconnect the base unit's AC adaptor, then reconnect the base unit's AC adaptor. Remove the batteries from the handset, and then insert the batteries into the handset again.

#### General use

Problem	Cause/solution
The unit does not work.	<ul style="list-style-type: none"> <li>• Make sure the batteries are installed correctly (page 7).</li> <li>• Fully charge the batteries (page 7).</li> <li>• Check the connections (page 7).</li> <li>• Unplug the base unit's AC adaptor to reset the unit. Reconnect the adaptor and try again.</li> <li>• The handset has not been registered to the base unit. Register the handset (page 29).</li> </ul>
I cannot hear a dial tone.	<ul style="list-style-type: none"> <li>• The base unit's AC adaptor or telephone line cord is not connected. Check the connections.</li> <li>• If you are using a splitter to connect the unit, remove the splitter and connect the unit to the wall jack directly. If the unit operates properly, check the splitter.</li> <li>• Disconnect the base unit from the telephone line and connect the line to a known working telephone. If the working telephone operates properly, contact our service personnel to have the unit repaired. If the working telephone does not operate properly, contact your service provider/telephone company.</li> </ul>



#### Programmable settings

Problem	Cause/solution
While programming, the handset starts to ring.	<ul style="list-style-type: none"> <li>• A call is being received. Answer the call and start again after hanging up.</li> </ul>

#### Battery recharge

Problem	Cause/solution
The handset beeps and/or  flashes.	<ul style="list-style-type: none"> <li>• Battery charge is low. Fully charge the batteries (page 7).</li> </ul>

**Useful Information**

Problem	Cause/solution
I fully charged the batteries, but  still flashes or  is displayed.	<ul style="list-style-type: none"> <li>• Clean the charge contacts and charge again (page 8).</li> <li>• It is time to replace the batteries (page 5).</li> </ul>
I fully charged the batteries, but the operating time seems to be shorter.	<ul style="list-style-type: none"> <li>• Clean the battery ends (+, -) and the charge contacts with a dry cloth, and charge again.</li> </ul>

**Making/answering calls, intercom**

Problem	Cause/solution
Noise is heard, sound cuts in and out.	<ul style="list-style-type: none"> <li>• You are using the handset or base unit in an area with high electrical interference. Reposition the base unit and use the handset away from sources of interference.</li> <li>• Move closer to the base unit.</li> <li>• If you use a DSL/ADSL service, we recommend connecting a DSL/ADSL filter between the base unit and the telephone line jack. Contact your DSL/ADSL provider for details.</li> </ul>
The handset does not ring.	<ul style="list-style-type: none"> <li>• The ringer volume is turned off. Adjust the ringer volume (page 17).</li> <li>• Night mode is turned on. Turn it off (page 19).</li> </ul>
I cannot make a call.	<ul style="list-style-type: none"> <li>• The dialing mode may be set incorrectly. Change the setting (page 10).</li> <li>• The handset is too far from the base unit. Move closer and try again.</li> <li>• Dial lock is turned on. To turn it off, see page 13.</li> </ul>

**Useful Information**

**Caller ID**

Problem	Cause/solution
<p>Caller information is not displayed.</p>	<ul style="list-style-type: none"> <li>● You need to subscribe to Caller ID service. Contact your service provider/telephone company for details.</li> <li>● If your unit is connected to any additional telephone equipment such as a Caller ID box or cordless telephone line jack, plug the unit directly into the wall jack.</li> <li>● If you use a DSL/ADSL service, we recommend connecting a DSL/ADSL filter between the base unit and the telephone line jack. Contact your DSL/ADSL provider for details.</li> <li>● Other telephone equipment may be interfering with this unit. Disconnect the other equipment and try again.</li> </ul>
<p>Caller information is displayed late.</p>	<ul style="list-style-type: none"> <li>● Depending on your service provider/telephone company, the unit may display the caller's information at the 2nd ring or later.</li> <li>● Move closer to the base unit.</li> </ul>
<p>Time on the unit has shifted.</p>	<ul style="list-style-type: none"> <li>● Incorrect time information from incoming Caller ID changes the time. Set the time adjustment to "Manual" (off) (page 18).</li> </ul>

**Useful Information**

**Registration**

Problem	Cause/solution
<p>The handset registration may have been canceled or the communication between the base unit and the handset is unstable.</p>	<ul style="list-style-type: none"> <li>• Re-register the handset.                             <ol style="list-style-type: none"> <li><b>1 Handset:</b> <b>[MENU]</b> → <b>[#][1][3][0]</b></li> <li><b>2 Base unit:</b> Press and hold <b>[*]</b> (Locator) for about 4 seconds. (No registration tone)                                     <ul style="list-style-type: none"> <li>– If another registered handset start ringing, press the same button to stop. Then repeat this step. (KX-TG3612)</li> <li>– The next step must be completed within 90 seconds.</li> </ul> </li> <li><b>3 Handset:</b> Press <b>[OK]</b>, then wait until a long beep sounds. → <b>[OFF]</b> <ul style="list-style-type: none"> <li>– While registering, “<b>Base registering</b>” is displayed on another handset. (KX-TG3612)</li> </ul> </li> </ol> <p>If the registration fails, try to deregister the handset.</p> <p><b>KX-TG3611</b> Press <b>[MENU]</b> → <b>[#][1][3][1]</b> → <b>[3][3][5]</b> → <b>[OK]</b> → <b>[1]</b>, then re-register it again.</p> <p><b>KX-TG3612</b> Use another handset to deregister the unstable handset. Press <b>[MENU]</b> → <b>[#][1][3][1]</b> → <b>[3][3][5]</b> → <b>[OK]</b> → <b>[1]</b> or <b>[2]</b> (The handset number which you want to cancel). Try to re-register it again.</p> </li> <li>• If the above remedy does not solve the problem, contact your nearest Panasonic service center.</li> </ul>

### Useful Information

#### Dial lock

##### Important:

- Anyone can turn off the dial lock using the following method. Be sure to keep these operating instructions in a safe place in order to prevent unauthorized persons from using your phone without permission.

Problem	Cause/solution
I cannot remember the dial lock password.	<ul style="list-style-type: none"> <li>• Turn the dial lock off using the following method.</li> </ul> <ol style="list-style-type: none"> <li><b>1</b> [MENU] → [#][2][5][1]</li> <li><b>2</b> Press [*][7][0][0][0].</li> <li><b>3</b> [Save] → [Yes] → [OFF]</li> </ol>

#### Liquid damage

Problem	Cause/solution
Liquid or other form of moisture has entered the handset/base unit.	<ul style="list-style-type: none"> <li>• Disconnect the AC adaptor and telephone line cord from the base unit. Remove the batteries from the handset and leave to dry for at least 3 days. After the handset/base unit are completely dry, reconnect the AC adaptor and telephone line cord. Insert the batteries and charge fully before use. If the unit does not work properly, contact an authorized service center.</li> </ul>

##### Caution:

- To avoid permanent damage, do not use a microwave oven to speed up the drying process.

**Index**

- A** Alarm: 19
- Answering calls: 11
- Area code: 21
- Auto talk: 11
- B** Battery: 7, 8
- Booster (Clarity booster): 13
- C** Caller ID service: 20
- Caller list: 20
- Caller list edit: 21
- Call share: 13
- Call waiting: 12
- Call Waiting Caller ID: 12
- Chain dial: 15
- CID (Caller ID): 20
- Conference calls: 23
- Control type: 9
- D** Date and time: 10
- Dialing mode: 10
- Dial lock: 13
- Direct commands: 17
- Display
  - Contrast: 17
- E** Emergency numbers: 14
- Error messages: 25
- F** Flash: 12, 17
- H** Handset locator: 23
- Hold: 12
- I** Intercom: 23
- K** Key tone: 17
- L** Line mode: 18
- M** Making calls: 11
- Missed calls: 20
- Mute: 12
- N** Night mode: 19
- P** Pause: 11
- Phonebook: 14
- Power failure: 8
- R** Redialing: 11
- Ringer tone: 17
- Rotary/pulse service: 13
- S** SP-PHONE (Speakerphone): 11
- T** Temporary tone dialing: 13
- Time adjustment: 18
- Transferring calls: 23
- Troubleshooting: 26
- V** Volume
  - Receiver: 11
  - Ringer (Handset): 12, 17
  - Speaker: 11
- W** Wall mounting: 24

**For your future reference**

We recommend keeping a record of the following information to assist with any repair under warranty.

Serial No.	Date of purchase
(found on the bottom of the base unit)	
Name and address of dealer	

Attach your purchase receipt here.

**Panasonic Communications Co., Ltd.**

1-62, 4-chome, Minoshima, Hakata-ku, Fukuoka 812-8531, Japan

**Copyright:**

This material is copyrighted by Panasonic Communications Co., Ltd., and may be reproduced for internal use only. All other reproduction, in whole or in part, is prohibited without the written consent of Panasonic Communications Co., Ltd.

© Panasonic Communications Co., Ltd. 2009



\*TG3611 BX\*

**PNQX1812ZA** CM0109DM0