

# Panasonic

Dual Handsets Digital Cordless Answering System



## Operating Instructions

Model No. **KX-TG2361JX**

Pulse-or-tone dialing capability

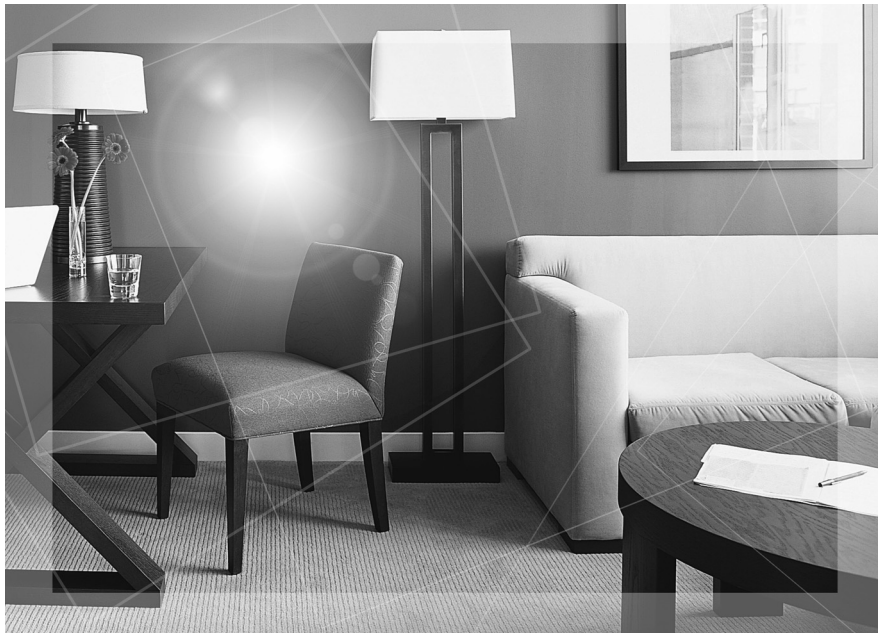

The unit is Caller ID compatible. To display the caller's phone number, you must subscribe to Caller ID service.

**PLEASE READ BEFORE USE AND SAVE.**

**Charge the battery for 6 hours before initial use.**

**Thank you for purchasing your new Panasonic cordless telephone.**





Caller ID Service, where available, is a telephone company service. After subscribing to Caller ID, this phone will display a caller's phone number.

**For your future reference**

Serial No. \_\_\_\_\_ Date of purchase \_\_\_\_\_  
(found on the bottom of the unit)

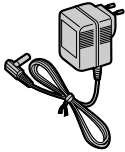
Name and address of dealer \_\_\_\_\_

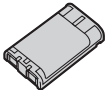
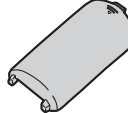
**Accessories (included)**

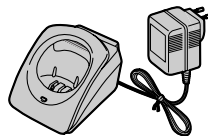
<input type="checkbox"/> AC Adaptor (p. 9)  one	<input type="checkbox"/> Telephone Line Cord (p. 9)  one
<input type="checkbox"/> Battery (p. 10)  two	<input type="checkbox"/> Handset Cover (p. 10)  two
<input type="checkbox"/> Belt Clip (p. 67)  two	<input type="checkbox"/> Charger Unit (p. 9)  one

## For Best Performance

---

### Battery Charge

The handset is powered by a rechargeable Nickel-Metal Hydride (Ni-MH) battery. Charge the battery for **6 hours** before initial use (p. 10).

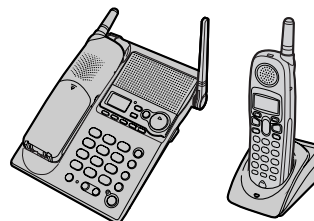

### Base Unit Location/Noise

Calls are transmitted between the base unit and handset using wireless radio waves. **For maximum distance and noise-free operation**, the recommended base unit location is:

Away from electrical appliances such as a TV, personal computer or another cordless phone.

In a **HIGH** and **CENTRAL** location with no obstructions such as walls.

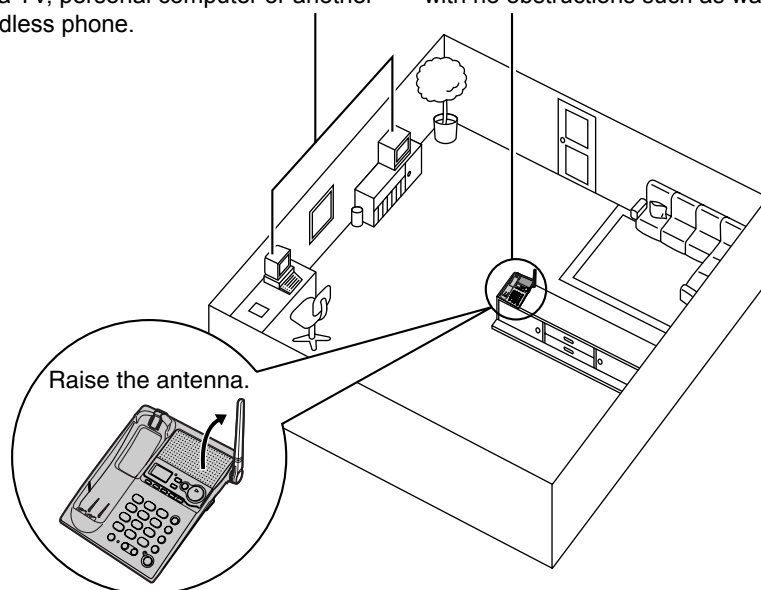

#### Note:

- If you use the handset near a microwave oven which is being used, noise may be heard from the receiver or the speaker. Move away from the microwave oven and closer to the base unit.
- If you use the handset near another cordless phone's base unit, noise may be heard. Move away from the other cordless phone's base unit and closer to your base unit.

# Contents

<b>Preparation</b>	
<b>Location of Controls</b> .....	<b>6</b>
<b>Installation</b> .....	<b>9</b>
Connections .....	9
Installing the Battery in the Handset .....	10
Battery Charge .....	10
<b>Programmable Settings</b> .....	<b>12</b>
Programming Guidelines ..	12
Function Menu Table .....	13
Date and Time .....	14
Dialing Mode .....	15
Line Mode .....	16
Auto Talk .....	16
Ringer Volume .....	17
Ringer Tone .....	18
LCD Contrast .....	20
<b>Preparing the Answering System</b> .....	<b>20</b>
Greeting Message .....	20
Caller's Recording Time ..	22
Number of Rings .....	23
Recording Mode .....	24
Message Alert .....	24
<b>Telephone System</b>	
<b>Making Calls</b> .....	<b>25</b>
Using the Handset .....	25
Using the Base Unit .....	28
<b>Answering Calls</b> .....	<b>29</b>
<b>Caller ID Service</b> .....	<b>30</b>
Using Talking Caller ID ..	31
<b>Using the Caller List</b> .....	<b>33</b>
Viewing the Caller List ..	33
Calling Back from the Caller List .....	34
Editing the Caller's Phone Number .....	35
Storing Caller Information in the Phone Book .....	36
Erasing Caller Information ..	37
<b>Phone Book</b> .....	<b>38</b>
Storing Names and Numbers .....	38
Dialing from the Phone Book .....	40
Chain Dial .....	41
Editing an Item in the Phone Book .....	42
Erasing an Item in the Phone Book .....	42
Copying Items in the Phone Book .....	43
<b>Intercom</b> .....	<b>45</b>
Making Intercom Calls .....	45
Answering Intercom Calls ..	46
Voice Paging .....	47
<b>Transferring a Call</b> .....	<b>48</b>
<b>Conference Calls</b> .....	<b>50</b>
Call Share .....	50
<b>Special Features</b> .....	<b>51</b>
Temporary Tone Dialing (For Rotary or Pulse Service Users) .....	51
Muting Your Conversation For Call Waiting Service Users .....	51
Using the PAUSE Key (For PBX Line/Long Distance Calls) .....	52
FLASH Button .....	52
Incoming Call Tone .....	53
Key Tone .....	54
Dial Lock .....	54
Re-registering the Handset .....	56

## Contents

<i>Answering System</i>	<i>Useful Information</i>	
<b>Automatic Answering</b>	<b>Belt Clip</b> . . . . .	<b>Preparation</b>
<b>Operation</b> . . . . . <b>57</b>	<b>Optional Headset</b> . . . . . <b>67</b>	
Setting the Unit to Answer	<b>Wall Mounting</b> . . . . . <b>68</b>	
Calls . . . . . <b>57</b>	<b>Direct Commands</b> . . . . . <b>70</b>	
Monitoring Incoming Calls . <b>58</b>	<b>If the Following Appears on Your</b>	
<b>Listening to Messages</b> . . . . . <b>59</b>	<b>Display...</b> . . . . . <b>72</b>	
Using the Base Unit . . . . . <b>59</b>	<b>Troubleshooting</b> . . . . . <b>74</b>	
Using the Handset (Remote	<b>Safety Instructions</b> . . . . . <b>78</b>	
Operation) . . . . . <b>60</b>	<b>Specifications</b> . . . . . <b>79</b>	
<b>Erasing Messages</b> . . . . . <b>62</b>		
<b>Recording a Memo</b>		
<b>Message</b> . . . . . <b>63</b>		
<b>Remote Operation from a Touch</b>		
<b>Tone Phone</b> . . . . . <b>64</b>		
Remote Code . . . . . <b>64</b>		<b>Answering System</b>
Voice Menu . . . . . <b>65</b>		
Direct Remote Operation . . <b>66</b>		
		<b>Useful Information</b>
<b>Important:</b>		
Throughout these Operating Instructions, <b>Handset</b> and <b>Base Unit</b> are used to indicate with which unit an operation can be performed.		
<b>Handset</b> :	Perform with the handset.	
<b>Base Unit</b> :	Perform with the base unit.	
<b>Handset Base Unit</b> :	Perform with the handset and base unit separately.	
<b>Handset &amp; Base Unit</b> :	Perform with the handset and base unit together.	

# Location of Controls

## Base unit

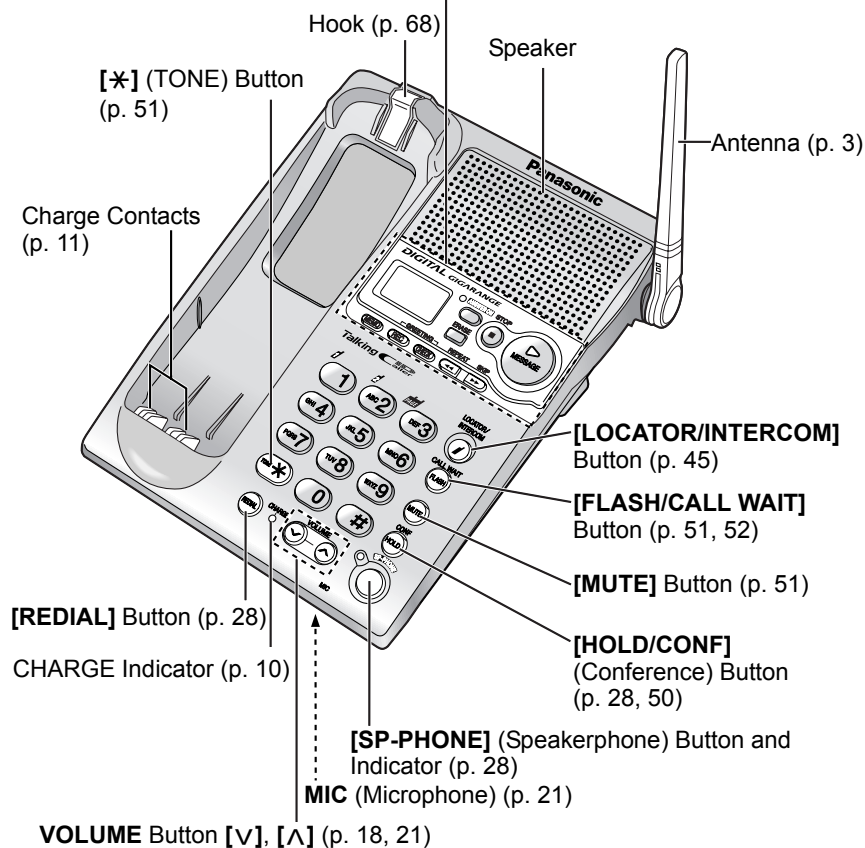
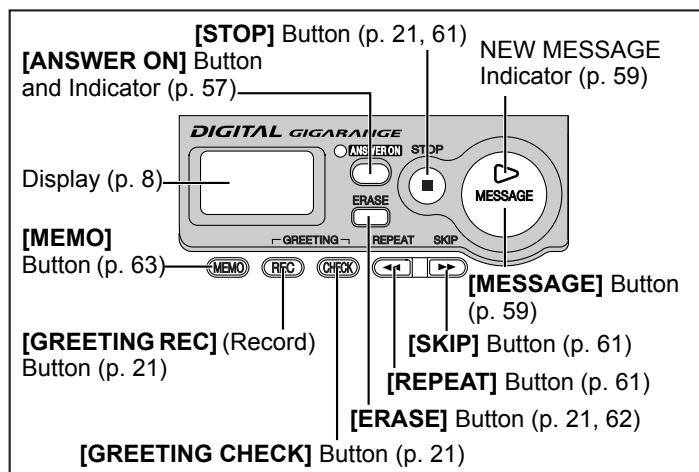

## Location of Controls

### Handset

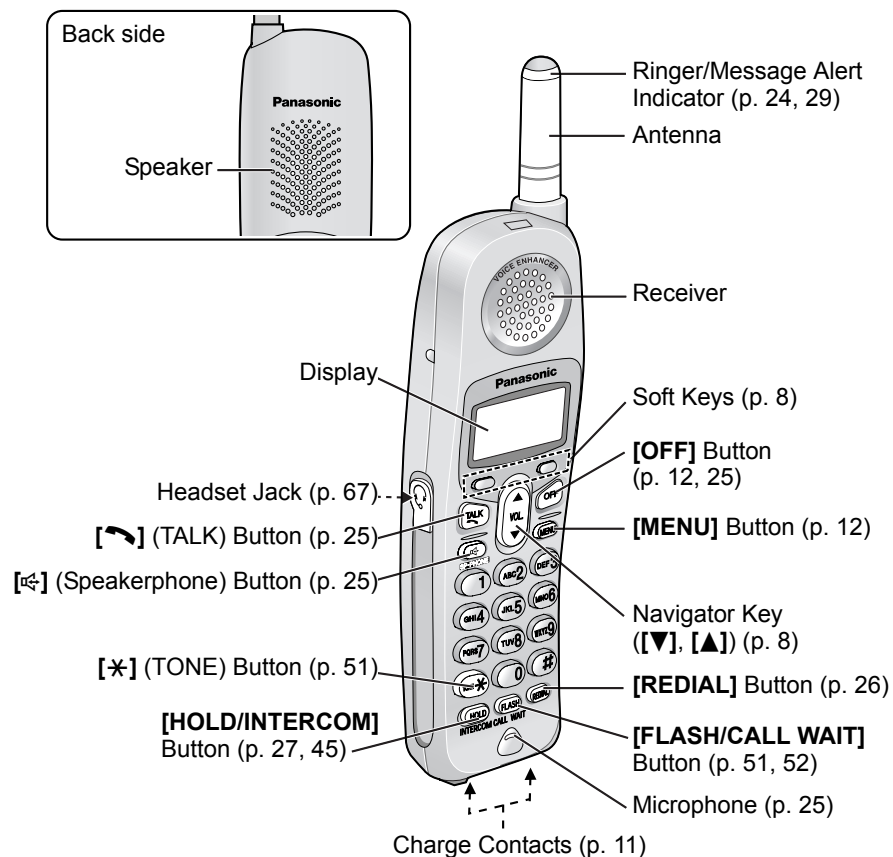

Preparation

### Charger unit

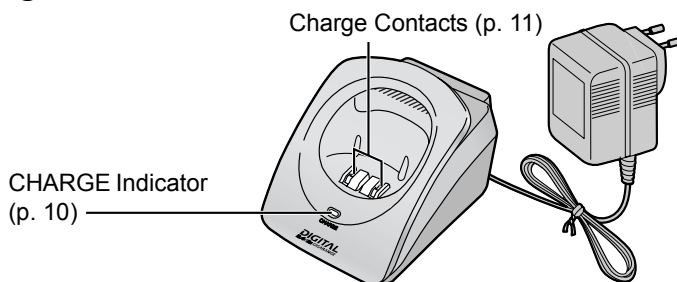

This unit includes two handsets and one base unit. The included handsets are pre-registered at the factory and assigned the extension numbers 1 and 2.

## Location of Controls

### Handset soft keys

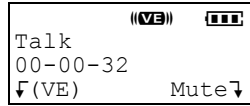

Two soft keys are used to select functions displayed directly above each key. Functions displayed above the keys will change depending on the state of use.

On this sample display, "VE" and "Mute" are displayed above soft keys.



Pressing the right soft key selects mute "Mute".

Pressing the left soft key selects Voice Enhancer "VE".

- When a function name does not appear above a soft key, the soft key has no function.

### Handset navigator key



Scrolls up [▲] and down [▼] the function menu, the Caller List and the phone book.

Increases [▲] or decreases [▼] the handset ringer and receiver/speaker volumes.

Throughout these Operating Instructions:

- The soft keys are indicated by what is displayed above the keys.  
Ex. "Press Mute." indicates "Press the soft key below Mute".
- The navigator key is indicated by the arrows [▼] or [▲].

### Base unit display

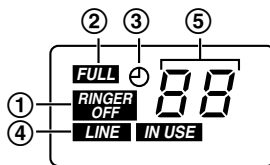

- ① "RINGER OFF" indicates the base unit ringer is off (p. 18).
- ② "FULL" flashes when no new messages can be recorded. Erase unnecessary messages (p. 62).
- ③ "+" flashes until you set the date and time, and flashes after a power failure. If it is flashing, set the date and time (p. 14).

- ④ "LINE IN USE" functions as follows.

Off (invisible)	The line is free.
On	The line is being used.
Flashing	A call is on hold on the handset or base unit or the Answering System is answering a call (p. 57).
Flashing rapidly	A call is being received.

- "IN USE" displays when a handset is operating the Answering System.

- ⑤ Message counter shows:
  - the total number of recorded messages. If the recording time is set to "Greeting only", "00" will be displayed (p. 22).
  - the selected volume level while you are adjusting the volume (p. 21, 28).
  - "E" when your greeting message or memo message was not recorded correctly (p. 21, 63).



# Installation

## Connections

### Base unit

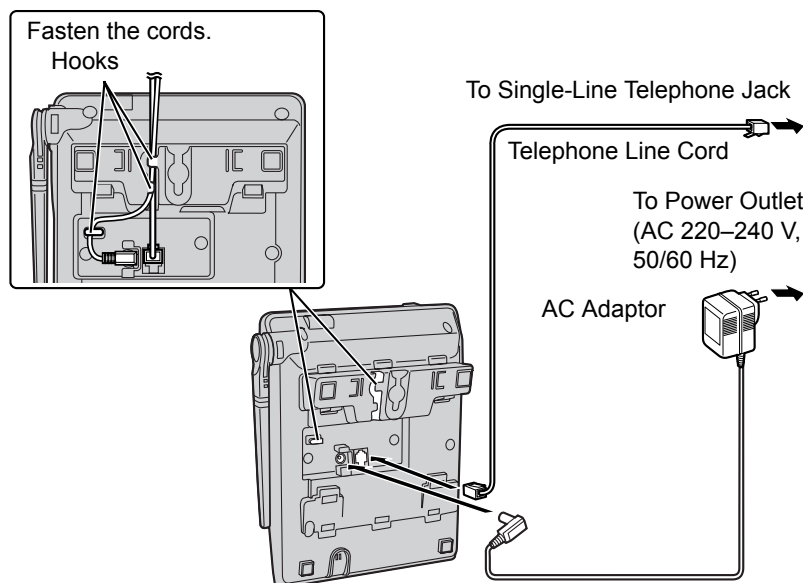

Preparation

- Base Unit: USE ONLY WITH Panasonic AC ADAPTOR PQLV1BX.
- The AC adaptor must remain connected at all times. (It is normal for the adaptor to feel warm during use.)
- If your unit is connected to a PBX which does not support Caller ID, you cannot access Caller ID services.
- The unit will not work during a power failure. We recommend connecting a standard telephone to the same telephone line or to the same telephone jack using a T-adaptor.
- When more than one unit is used, the units may interfere with each other. To prevent or reduce interference, please keep ample space between the base units.

### Charger unit

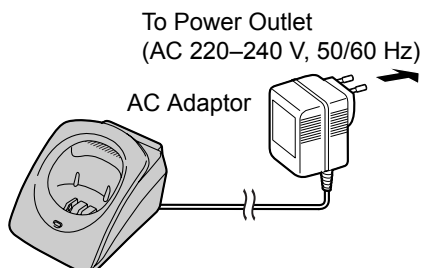

- Charger unit: USE ONLY WITH Panasonic AC ADAPTOR KX-TCA1BX.
- The AC adaptor must remain connected at all times. (It is normal for the adaptor to feel warm during use.)

## Installation

### Installing the Battery in the Handset

Insert the battery (①), and press it down until it snaps into the compartment (②). Close the cover.

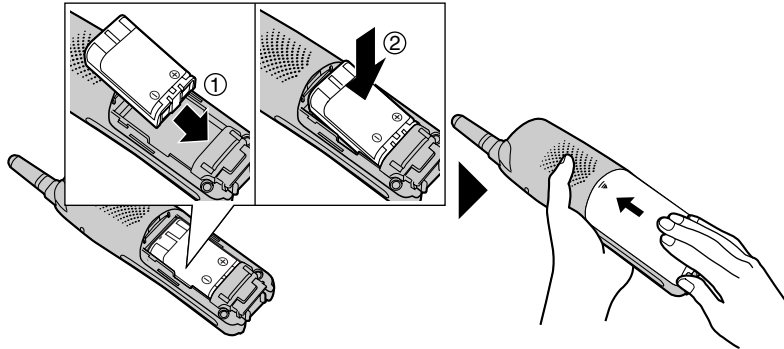

#### To replace the battery:

Press the notch on the cover firmly and slide it as indicated by the arrow. Replace the old battery with a new one (p. 11). Close the cover and charge the battery for 6 hours.

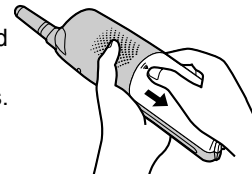

### Battery Charge

Place the handsets on the base unit and charger. Charge for **6 hours** before initial use.

- The unit beeps once, the CHARGE indicator lights, and "Charging" is displayed.
- When the battery is fully charged, "Charge completed" is displayed.

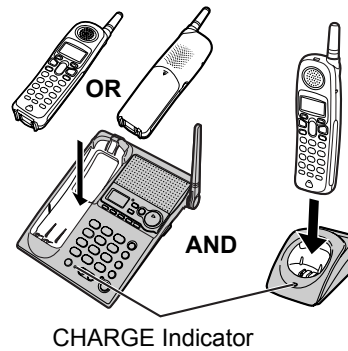

### Battery strength

You can confirm battery strength on the handset display. Battery strength is indicated by the icons shown in the chart to the right.

Display prompt	Battery strength
	Fully charged
	Medium
	Low
(flashing)	Needs to be recharged.
	Discharged



## Installation

### Recharge

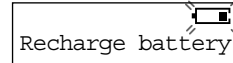

Recharge the battery when:

- “Recharge battery” is displayed on the handset,
- “” flashes, or
- the handset beeps intermittently while it is in use.



- The display will continually indicate “Recharge battery” and/or “” will flash when the handset battery is charged for less than 15 minutes and the handset is lifted off the base unit or charger.
- If the battery has been discharged, the handset will display “Charge for 6h” and “” when you place the handset on the base unit or charger. The handset will not work unless the battery is charged. Continue charging.

#### Battery replacement:

If you cleaned the charge contacts and fully charged the battery, but after a few telephone calls, “Recharge battery” is displayed and/or “” continues to flash, or “Charge for 6h” and “” are displayed, the battery may need to be replaced. Please replace with a new Panasonic HHR-P104 battery. To replace the battery, see page 10.

Preparation

### Battery information

After your Panasonic battery is fully charged, you can expect the following performance:

Operation	Operating time
While in use (TALK)	Up to 5 hours
While not in use (Standby)	Up to 11 days

- A fully charged battery will give you up to 5 hours of continuous talk time, or keep your handset in Standby mode to receive incoming calls for up to 11 days (if no phone calls are made). Battery power is consumed whenever the handset is off of the base unit or charger, even when the handset is not in use. The longer you leave the handset off of the base unit or charger, the time you can actually talk on the handset will be shortened. Actual battery performance depends on a combination of how often the handset is in TALK mode and how often it is in Standby mode.
- **Clean the charge contacts of the handset, the base unit and the charger with a soft, dry cloth once a month. Clean more often if the unit is subject to grease, dust or high humidity.** Otherwise the battery may not charge properly.
- If the battery is fully charged, you do not have to place the handset on the base unit or charger until “Recharge battery” is displayed and/or “” flashes. This will maximize the battery life.
- If you want to keep the battery fully charged at all times, place the handset on the base unit or charger when the handset is not used. The battery cannot be overcharged.

# Programmable Settings

## Programming Guidelines **Handset**

This unit has several programmable functions which can be selected from the function menu on the display (p. 13).

The **soft keys** selects the functions displayed above each soft key.

When “▼” or “▲” is displayed, navigator key scrolls through the menu.

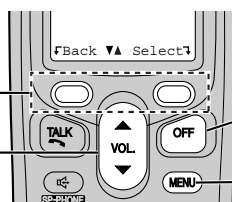

[OFF] exits programming.

[MENU] enters the function menu.

### How to select a function item from the menu

**Make sure the handset and base unit are not being used. The handset must be operated near the base unit and while off the base unit or charger.**

**1** Press **[MENU]**.

- The main menu is displayed (p. 13).

**2** Scroll to the desired item by pressing **[▼]** or **[▲]**.

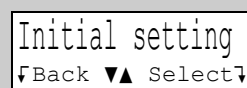

**3** Press **select** to select the desired item.



**4** If the item has a sub-menu, select the menu item (p. 13). Repeat steps 2 and 3 until the desired item is displayed. If the item has no sub-menu, go to step 5.

**5** Select the desired setting by pressing **[▼]** or **[▲]**, then press **save** to save your setting.

- A confirmation tone will be heard and the setting will be saved.



**6** Press **[OFF]** to exit programming mode.

- To go back to the previous menu, press **Back**, or press **Select** while “--- (Go back) ---” is displayed. If you press this key in the main menu, the unit will exit programming mode.
- After programming is complete, the display will return to the main menu or the sub-menu depending on which menu the selected item is located. (See the menu table on page 13.)
- You can exit programming mode at any time by pressing **[OFF]**.
- If you do not press any buttons for 60 seconds, the handset will exit programming mode.
- If the unit detects a problem, an error message will be displayed (p. 72–73) and/or error beeps will sound.

## Programmable Settings

### Function Menu Table **Handset**

You can use the following functions to customize your unit. See the corresponding pages for function details.

- After pressing **[MENU]**, you can also program menu items directly by pressing **[0]** to **[9]**, **[\*]** and **[#]** instead of using the soft keys (p. 70–71).

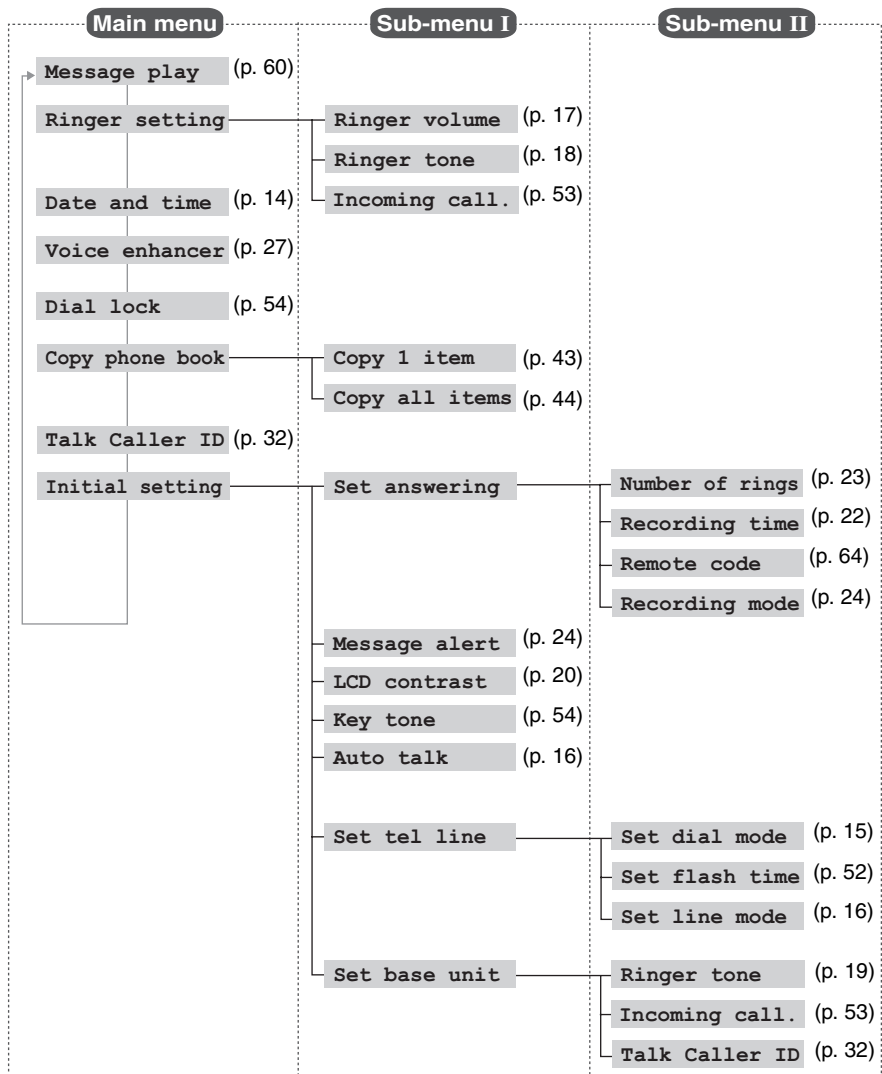

- If you program the date and time, dial lock, dialing mode, flash time, line mode, number of rings, recording time, recording mode or the remote code using one of the handsets, you will not need to program the same item using another handset.

## Programmable Settings

### Date and Time **Handset**

You need to set the date and time;

- to display the time and date the calls were received in the Caller List, and
- to announce the day and time when each message was recorded, during a message playback.

**1** Press **[MENU]**.

**2** Scroll to “Date and time” by pressing **[▼]** or **[▲]**, then press **Select**.

Date and time  
↵ Back ▼▲ Select ↵

**3** ① Enter 2 digits each for the day, month, and year. (Ex. To set May 15, 2004, enter “15 05 04”.)

Date: 31.12.2004  
Time: 12:00 AM  
↵ AM/PM Save ↵

② Enter 4 digits for the time (hour and minute). (Ex. To set 9:30, enter “0930”.)

Example  
Date: 15.05.2004  
Time: 09:30 AM  
↵ AM/PM Save ↵

- If you enter a wrong number, press **[▼]** or **[▲]** to move the cursor to the incorrect number. Enter the correct number.

**4** Select “AM” or “PM” by pressing **AM/PM**.

Date: 15.05.2004  
Time: 09:30 AM  
↵ AM/PM Save ↵

**5** Press **Save**.

- The date and time are set and “⓪” disappears from the base unit display.
- If the handset beeps 3 times, the date and time were not set correctly. Start again from step 3.

**6** Press **[OFF]**.

- When entering the time in step 3, you cannot enter numbers greater than 12. **Do not use military time.** (To set 13:00 hours, enter “0100”, then select “PM” in step 4.)

The date and time may be incorrect after a power failure. When “⓪” flashes on the base unit display or “⓪ Press MENU.” flashes on the handset display, adjust the date and time.

**To adjust the date and time when “⓪ Press MENU.” flashes on the handset display:**

Press **[MENU]**, then go to step 3 above.

**To confirm the date and time**, repeat steps 1 and 2 above.

- The current date and time are displayed. When finished, press **[OFF]**.

## Programmable Settings

### Dialing Mode **Handset**

If you have touch tone service, set the dialing mode to “Tone”. For rotary or pulse service, set to “Pulse”. The factory preset is “Tone”.

**1** Press **[MENU]**.

**2** Scroll to “Initial setting” by pressing **[▼]** or **[▲]**, then press **Select**.

```
Initial setting
└Back ▼▲ Select┘
```

**3** Scroll to “Set tel line” by pressing **[▼]** or **[▲]**, then press **Select**.

```
Set tel line
└Back ▼▲ Select┘
```

**4** Press **Select** at “Set dial mode”.

```
Set dial mode
└Back ▼▲ Select┘
```

**5** Select “Pulse” or “Tone” by pressing **[▼]** or **[▲]**.

```
Set dial mode
:Tone
└Back ▼▲ Save┘
```

**6** Press **Save**, then press **[OFF]**.

Preparation

## Programmable Settings

### Line Mode **Handset**

The line mode is preset to “B” and generally should not be adjusted. If “Line in use” on the handset and “**LINE IN USE**” on the base unit are not displayed properly, the line mode selection is incorrect. Set line mode to “A”.

1 Press **[MENU]**.

2 Scroll to “Initial setting” by pressing **[▼]** or **[▲]**, then press **Select**.

```
Initial setting
┆Back ▼▲ Select┆
```

3 Scroll to “Set tel line” by pressing **[▼]** or **[▲]**, then press **Select**.

```
Set tel line
┆Back ▼▲ Select┆
```

4 Scroll to “Set line mode” by pressing **[▼]** or **[▲]**, then press **Select**.

```
Set line mode
┆Back ▼▲ Select┆
```

5 Select “A” or “B” by pressing **[▼]** or **[▲]**.

```
Set line mode
: B
┆Back ▼▲ Save┆
```

6 Press **save**, then press **[OFF]**.

### Auto Talk **Handset**

The Auto Talk feature allows you to answer calls by simply lifting the handset off the base unit or charger. You do not need to press **[📞]** or **[📞]**. The factory preset is OFF.

1 Press **[MENU]**.

2 Scroll to “Initial setting” by pressing **[▼]** or **[▲]**, then press **Select**.

```
Initial setting
┆Back ▼▲ Select┆
```

3 Scroll to “Auto talk” by pressing **[▼]** or **[▲]**, then press **Select**.

```
Auto talk
┆Back ▼▲ Select┆
```

4 Select “On” or “Off” by pressing **[▼]** or **[▲]**.

```
Auto talk
: Off
┆Back ▼▲ Save┆
```

5 Press **save**, then press **[OFF]**.

- In order to view Caller ID information after you lift the handset to answer a call, leave the Auto Talk feature turned off.



## Programmable Settings

### Ringer Volume

You can select the handset or base unit ringer volumes to high, medium, low, or off. The factory preset is HIGH. If the handset and base unit ringer is turned off, the handset or base unit will ring at the low level for intercom calls, and will not ring for outside calls. Caller names will not be announced even if the Talking Caller ID feature is turned on (p. 32).

Preparation

#### Handset ringer volume **Handset**

**1** Press **[MENU]**.

**2** Scroll to “Ringer setting” by pressing **[▼]** or **[▲]**, then press **Select**.

```
Ringer setting
└Back ▼▲ Select┘
```

**3** Press **Select** at “Ringer volume”.

```
Ringer volume
└Back ▼▲ Select┘
```

**4** Select the desired volume level by pressing **[▼]** or **[▲]**.

- The volume will change and ring.
- The number of steps indicates the volume level.
- **To turn the ringer off**, press **[▼]** repeatedly until “Off ?” is displayed.

```
Ex. High
Ringer volume
Low ■■■■■ High
└Back ▼▲ Save┘
```

**5** Press **Save**.

- If the handset ringer is turned off, “Ringer off” will be displayed while not in use.  
“Ringer off” is not displayed, if the handset is off the base unit or charger when:
  - there are missed calls (p. 33) or new messages (p. 60), or
  - the Dial Lock is turned on (p. 54).
- You can adjust the ringer volume while an outside call is ringing. Press **[▼]** or **[▲]** while the handset is ringing.

#### Temporary ringer off

While the handset is ringing for an outside call, you can turn the ringer off temporarily by pressing **[OFF]**. The handset will ring again as normal the next time a call is received.

## Programmable Settings

### Base unit ringer volume **Base Unit**

Make sure the base unit is not being used.

To set the ringer volume to high (preset), medium, or low, press **VOLUME [V]** or **[^]**.

- To increase volume, press **VOLUME [^]**.  
To decrease volume, press **VOLUME [V]**.
- To stop ringing, press **[STOP]**.

To turn the ringer off, press and hold **VOLUME [V]** until 2 beeps sound.

- “**RINGER OFF**” is displayed.

To turn the ringer on, press **VOLUME [V]** or **[^]**.

- The base unit will ring at the low level.
- You can adjust the ringer volume while an outside call is ringing.  
Press **VOLUME [V]** or **[^]** while the base unit is ringing.  
To turn the ringer off, press and hold **VOLUME [V]** until 2 beeps sound.  
“**RINGER OFF**” is displayed.

## Ringer Tone

You can set the handset and base unit ringers to use one of 7 ringer patterns for outside calls. “Tone 1” to “Tone 3” are bell ringer patterns. “Melody 1” to “Melody 4” are melody patterns. The factory preset is “Tone 1”.

- You cannot change the ringer tone for intercom calls.
- If you select one of the melody ringer patterns, the ringer will continue to sound for several seconds if:
  - the caller hangs up before you answer the call, or
  - another person answers the call using another phone connected on the same line.

### Handset ringer tone **Handset**

1 Press **[MENU]**.

2 Scroll to “Ringer setting” by pressing **[▼]** or **[▲]**, then press **select**.

Ringer setting  
↵Back ▼▲ Select↵

3 Scroll to “Ringer tone” by pressing **[▼]** or **[▲]**, then press **select**.

Ringer tone  
↵Back ▼▲ Select↵

## Programmable Settings

**4** Select the desired ringer tone by pressing [▼] or [▲].

- The handset will ring and the ringer tone will change. If the ringer volume has been turned off, the handset will not ring (p. 17).
- You can also select the ringer tone by pressing [1] to [7].

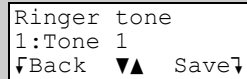

```
Ringer tone
1: Tone 1
↓Back  ▼▲  Save↓
```

**5** Press **save**, then press [OFF].

Preparation

### Base unit ringer tone (use either the handset or the base unit)

#### Base Unit

Make sure the base unit is not being used.

Press **VOLUME** [V] or [^], then select the desired ringer tone by pressing [1] to [7].

[1] to [3] : Bell ringer patterns      [4] to [7] : Melody patterns

- After pressing **VOLUME** [V] or [^], the base unit will ring using the current ringer tone.
- The base unit will ring and the ringer tone will change.
- To stop ringing, press [STOP].

#### Setting the base unit ringer tone by using the Handset

**1** Press [MENU].

**2** Scroll to “Initial setting” by pressing [▼] or [▲], then press **Select**.

**3** Scroll to “Set base unit” by pressing [▼] or [▲], then press **Select**.

**4** Press **Select** at “Ringer tone”.

**5** Select the desired ringer tone by pressing [▼] or [▲].

- The base unit will ring and the ringer tone will change. If the base unit ringer volume has been turned off, the base unit will not ring (p. 18).
- You can also select the ringer tone by pressing [1] to [7].

**6** Press **save**, then press [OFF].

## Programmable Settings

### LCD Contrast **Handset**

There are 6 levels of LCD contrast. The factory preset is "level 3".

**1** Press **[MENU]**.

**2** Scroll to "Initial setting" by pressing **[▼]** or **[▲]**, then press **Select**.

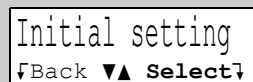

Initial setting  
↵Back ▼▲ Select↵

**3** Scroll to "LCD contrast" by pressing **[▼]** or **[▲]**, then press **Select**.



LCD contrast  
↵Back ▼▲ Select↵

**4** Select the desired contrast by pressing **[▼]** or **[▲]**.

- The contrast will change.



Ex. Level 3  
LCD contrast  
Low ■■■ High  
↵Back ▼▲ Save↵

**5** Press **save**, then press **[OFF]**.

## Preparing the Answering System

### Greeting Message **Base Unit**

You can record a personal greeting message of **up to 2 minutes**. If you do not record your own message, one of two pre-recorded greetings will be played for callers (p. 22).

The total recording time of all messages (greeting, incoming and memo) is **about 16 minutes**.

We recommend you record a **brief greeting message** in order to leave more time for recording new messages.

- You can use the enhanced recording mode for clearer sound, if necessary (p. 24).

## Preparing the Answering System

### To record a greeting message

#### Sample greeting message

"Hello, this is (your name and/or number). Sorry, I cannot take your call. Please leave a message after the beep. Thank you."

- 1 Press **[GREETING REC]**.
  - "To record greeting, press RECORD again" is heard.
- 2 Within 10 seconds, press **[GREETING REC]** again to record your greeting.
- 3 After the long beep, talk clearly, about 20 cm away from the **MIC** (microphone).
  - The elapsed recording time is displayed.
  - If you record for over 2 minutes, the unit will stop recording.
- 4 When finished, press **[GREETING REC]** or **[STOP]**.
  - To change the greeting, start again from step 1.

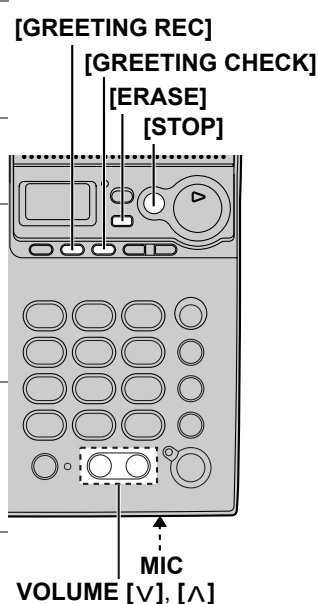

- If "E" is displayed, 6 beeps sound and "Your greeting was not recorded. Record your greeting again." is announced, start again from step 1.

**To adjust the speaker volume, press VOLUME [V] or [^] during playback.**

- 9 levels (0–8) are available while using the Answering System. The level is displayed on the base unit.

### To review the greeting

Press **[GREETING CHECK]**.

### To erase the greeting

Press **[GREETING CHECK]**, then press **[ERASE]** while the recorded message is being played.

- The unit will answer calls with a pre-recorded greeting (p. 22).

## Preparing the Answering System

### Pre-recorded greeting

If you do not record a greeting (p. 20, 21), one of two greetings will be played when a call is received, depending on the caller's recording time (see below).

**To review the pre-recorded greeting, press [GREETING CHECK].**

- A pre-recorded greeting will be played as follows:
  - When the recording time is set to "1 minute", "2 minutes" or "3 minutes":  
"Hello, we are not available now. Please leave your name and phone number after the beep. We will return your call."
  - If recording time runs out, the unit will automatically switch to the "Greeting only" mode (see below), and no new messages will be recorded.
  - When the recording time is set to "Greeting only":  
"Hello, we are not available now. Please call again. Thank you for your call."

#### Flash Memory Message Backup (Message storage)

Messages stored in memory will not be affected by power failures. All messages are saved until you erase them.

### Caller's Recording Time **Handset**

You can select "1 minute", "2 minutes", "3 minutes" or "Greeting only" for the caller's recording time. The factory preset is "3 minutes".

**1** Press **[MENU]**.

**2** Scroll to "Initial setting" by pressing **[▼]** or **[▲]**, then press **Select**.

Initial setting  
↓Back ▼▲ Select↓

**3** Press **Select** at "Set answering".

Set answering  
↓Back ▼▲ Select↓

**4** Scroll to "Recording time" by pressing **[▼]** or **[▲]**, then press **Select**.

Recording time  
↓Back ▼▲ Select↓

**5** Select the recording time by pressing **[▼]** or **[▲]**.  
• You can also select the recording time by pressing **[1]**, **[2]**, **[3]** or **[0]** (Greeting only).

Recording time  
:3min  
↓Back ▼▲ Save↓

**6** Press **Save**, then press **[OFF]**.

## Preparing the Answering System

If you select "Greeting only", the unit will answer calls with the greeting message, and then hang up. The unit will not record any incoming messages. The base unit will display "GO" instead of the number of messages.

### Number of Rings **Handset**

You can select the number of times the unit rings before the Answering System answers a call, from "2" to "7" or "Toll saver"\*. The factory preset is "4".

**1** Press **[MENU]**.

**2** Scroll to "Initial setting" by pressing **[▼]** or **[▲]**, then press **Select**.

```
Initial setting
┆Back ▼▲ Select┆
```

**3** Press **Select** at "Set answering".

```
Set answering
┆Back ▼▲ Select┆
```

**4** Press **Select** at "Number of rings".

```
Number of rings
┆Back ▼▲ Select┆
```

**5** Select the number of rings by pressing **[▼]** or **[▲]**.

- You can also select the number of rings by pressing **[0]** (Toll saver\*), or **[2]** to **[7]**.

```
Number of rings
:4
┆Back ▼▲ Save┆
```

**6** Press **save**, then press **[OFF]**.

#### \*Toll saver

When you call the unit from a remote operation, the number of rings will tell you if there are any new messages. If the unit answers on the 2nd ring, there is at least one new message. If the unit answers on the 4th ring, there are no new messages. To save the toll charges for the call, hang up immediately when you hear the 3rd ring. The 3rd ring indicates that there are no new messages.

## Preparing the Answering System

### Recording Mode **Handset**

Two recording modes are available. The factory preset is “Standard recording (16min)”, which provides more recording time (16min) and standard sound quality. “Enhanced recording (8 min)” provides less recording time (8 min) but clearer sound quality.

**1** Press **[MENU]**.

**2** Scroll to “Initial setting” by pressing **[▼]** or **[▲]**, then press **Select**.

**3** Press **Select** at “Set answering”.

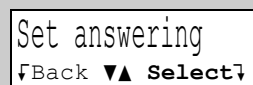

```
Set answering
Back Select
```

**4** Scroll to “Recording mode” by pressing **[▼]** or **[▲]**, then press **Select**.



```
Recording mode
Back Select
```

**5** Select the recording mode by pressing **[▼]** or **[▲]**.

- You can also select the recording mode by pressing **[1]** (Standard) or **[2]** (Enhanced).

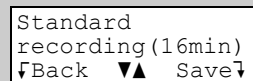

```
Standard
recording (16min)
Back Save
```

**6** Press **save**, then press **[OFF]**.

### Message Alert **Handset**

You can select whether or not the Ringer/Message Alert indicator on the handset will flash slowly when new messages have been recorded (p. 60). The factory preset is OFF.

**1** Press **[MENU]**.

**2** Scroll to “Initial setting” by pressing **[▼]** or **[▲]**, then press **Select**.

**3** Scroll to “Message alert” by pressing **[▼]** or **[▲]**, then press **Select**.

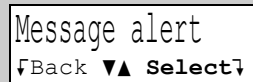

```
Message alert
Back Select
```

**4** Select “On” or “Off” by pressing **[▼]** or **[▲]**.

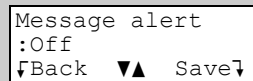

```
Message alert
:Off
Back Save
```

**5** Press **save**, then press **[OFF]**.

- The Ringer/Message Alert indicator will not flash for new messages while the handset is in use.
- The Ringer/Message Alert indicator acts both as a ringer indicator and as a message alert indicator. This indicator will flash rapidly when a call is received whether this feature is on or off.
- Battery operating time may be shortened when using this feature (p. 11).



# Making Calls

## Using the Handset **Handset**

- 1 Press [**📞**].
  - "Talk" is displayed.
- 2 Dial a phone number.
  - The dialed number is displayed.
  - After a few seconds, the display will show the length of the call.
- 3 To hang up, press [**OFF**] or place the handset on the base unit or charger.

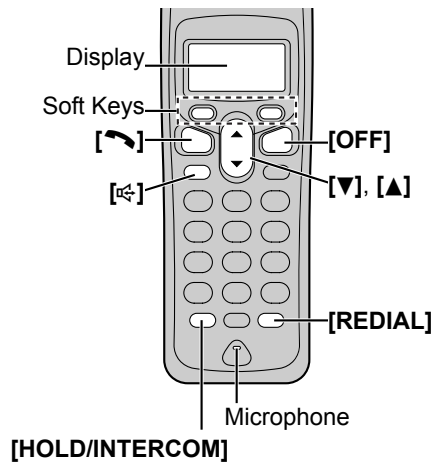

Telephone System

## To have a hands-free phone conversation

- 1 Press [**📞**].
  - "SP-phone" is displayed.
- 2 Dial a phone number.
  - The dialed number is displayed.
  - After a few seconds, the display will show the length of the call.
- 3 When the other party answers, talk into the microphone.
- 4 To hang up, press [**OFF**] or place the handset on the base unit or charger.

### Hands-free Digital Duplex Speakerphone

For best performance, please note the following:

- Talk alternately with the other party in a quiet room.
- If you or the other party has difficulty hearing, press [**▼**] to decrease the speaker volume.
- While talking using [**📞**], you can switch to a hands-free phone conversation by pressing [**📞**]. To switch back to the receiver, press [**📞**].

## Making Calls

### To dial after confirming the entered number

- 1 Enter a phone number.

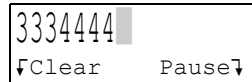

- If you misdial, press **Clear**. Enter the correct number.
- If a pause is required when dialing, press **Pause** where needed (p. 52).
- To cancel, press **[OFF]**.

- 2 Press [**↶**] or [**↷**].

- 3 To hang up, press **[OFF]** or place the handset on the base unit or charger.

### To adjust the receiver/speaker volume during a conversation

There are 3 volume levels for the receiver and 6 volume levels for the speaker.

To increase volume, press [**▲**].

To decrease volume, press [**▼**].

Ex. Receiver volume: High  
Speaker volume: Level 6



- The display shows the current volume setting.
- If you try to increase/decrease volume when it is at the maximum/minimum level, the handset will beep 3 times.

### To redial the last number dialed

Press [**↶**] or [**↷**], then press **[REDIAL]**.

### To redial using the redial list (Memory Redial)

The last 5 phone numbers dialed are stored in the redial list.

- 1 Press **[REDIAL]**.

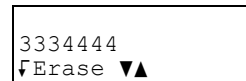

- The last number dialed is displayed.

- 2 Scroll to the desired number by pressing [**▼**] or [**▲**].

- You can also scroll down through the list by pressing **[REDIAL]**.
- To exit the list, press **[OFF]**.

- 3 Press [**↶**] or [**↷**].

- **To erase an item**, scroll to the item then press **Erase**.
- If "No items stored" is displayed, the list is empty.

## Making Calls

### To put a call on hold

**1** Press **[HOLD/INTERCOM]** during a conversation.

- “Line on hold.” is displayed.
- To transfer the call to the base unit or another handset, see pages 48– 49.

**2** Press **[HOLD/INTERCOM]** again.

- “Hold” is displayed.
- You can search the Caller List or phone book while a call is on hold. To exit the list, press **[OFF]**. The call will remain on hold.

**To return to the call, press [↶] or [↷].**

- The base unit user can also take the call by pressing **[SP-PHONE]**.
- Another handset user can also take the call by pressing **[↶]** or **[↷]**.
- If another phone is connected on the same line (p. 9), you can also take the call by lifting its handset.
- If a call is kept on hold for 6 minutes, an alarm tone will start to sound and the Ringer/Message Alert indicator will start to flash rapidly. After 4 additional minutes on hold, the call will be disconnected.

### Voice Enhancer Technology

Panasonic’s Voice Enhancer Technology clarifies the voice of the person you are talking to, reproducing a more natural-sounding voice that is easier to hear and understand.

Voice Enhancer Technology can be turned on or off. The factory preset is OFF.

- Depending on the condition and quality of your telephone line, this feature may emphasize existing line noise. If it becomes difficult to hear, turn this feature off.

**To turn this feature on, press (VE) during a conversation.**

- “(VE)” is displayed.
- **To turn this feature off, press (VE) again.** “(VE)” disappears from the display.
- After hanging up a call, the on/off setting will be retained.

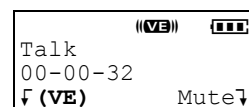

When the handset is not in use, you can also turn this feature on or off by programming as follows:

1. Press **[MENU]**.
2. Scroll to “Voice enhancer” by pressing **[▼]** or **[▲]**, then press **Select**.
3. Select “On” or “Off” by pressing **[▼]** or **[▲]**.
4. Press **Save**, then press **[OFF]**.

### Backlit LCD display/Lighted handset keypad

The handset display and dialing buttons will light for a few seconds after pressing a button or lifting the handset off the base unit or charger. They will also light when an intercom/outside call is being received.

## Making Calls

### Using the Base Unit **Base Unit**

- 1 Press **[SP-PHONE]**.
  - The SP-PHONE indicator lights.
- 2 Dial a phone number.
- 3 When the other party answers, talk into the **MIC** (microphone).
- 4 To hang up, press **[SP-PHONE]**.
  - The indicator light goes out.

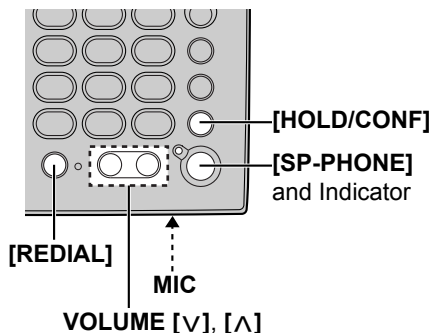

- To switch to the handset while using the base unit speakerphone:
  - If the handset is off the base unit or charger, press [**↶**] or [**↷**] on the handset, then press **[SP-PHONE]** on the base unit.
  - If the handset is on the base unit, just lift up.

#### **Hands-free Digital Duplex Speakerphone**

For best performance, please note the following:

- Talk alternately with the other party in a quiet room.
- If you or the other party has difficulty hearing, press **VOLUME [V]** to decrease the speaker volume.

### **To adjust the speaker volume during a conversation**

To increase volume, press **VOLUME [^]**.

To decrease volume, press **VOLUME [V]**.

- There are 8 volume levels. If you try to increase/decrease volume when it is at the maximum/minimum level, the base unit will beep 3 times.

### **To redial the last number dialed**

Press **[SP-PHONE]**, then press **[REDIAL]**.

### **To put a call on hold**

Press **[HOLD/CONF]** during a conversation.

- The SP-PHONE indicator flashes.

**To return to the call, press [SP-PHONE].**

- The handset user can also take the call by pressing [**↶**] or [**↷**].
- If another phone is connected on the same line (p. 9), you can also take the call by lifting its handset.
- If a call is kept on hold for 6 minutes, an alarm tone will start to sound. After 4 additional minutes on hold, the call will be disconnected.

## Answering Calls

When a call is received, the unit rings, "Incoming call" is displayed, and the Ringer/Message Alert indicator on the handset and "**LINE IN USE**" on the base unit flash rapidly. If you subscribe to Caller ID, see page 30.

### Handset

- 1 Press [📞] or [📞].
  - You can also answer a call by pressing any button except [▼], [▲] or [OFF].
- 2 To hang up, press [OFF] or place the handset on the base unit or charger.

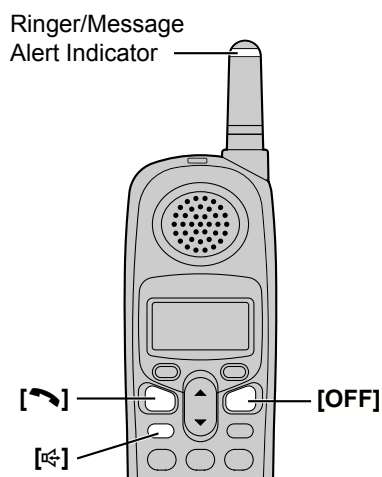

### Auto Talk

If the Auto Talk feature is turned on (p. 16), you can answer a call by simply lifting the handset off the base unit or charger.

### Temporary ringer off

You can turn the ringer off temporarily by pressing [OFF], while the handset is ringing for an outside call. The handset will ring again as normal the next time a call is received.

### Base Unit

- 1 Press [SP-PHONE].
- 2 Talk into the MIC.
- 3 To hang up, press [SP-PHONE].

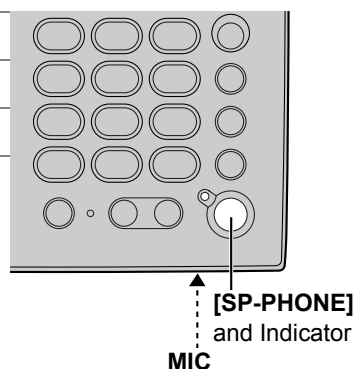

- To transfer the call to another person, see pages 48–49.
- If the ringer volume is turned off, the unit will not ring (p. 17, 18).

## Caller ID Service

This unit is compatible with Caller ID services offered by your telephone company. If you subscribe to Caller ID, caller's information will be displayed and recorded in the Caller List.

### How Caller ID information is displayed

When a call comes in, the unit will ring and the caller information will be received. Once the caller information is received, the handset display shows the caller's phone number after the ring.\*

Example

15552223333

- After you answer the call, the display will show the length of the call.

#### \*Private name display

If you receive a call from one of the phone numbers stored in the phone book, the handset will show the caller's name stored in the phone book.

Example

TINA ROBINSON  
15552223333

- To use this function, names and phone numbers must be stored in the phone book (p. 38).
- If the handsets each have the same phone number stored with a different name, each handset will display the name stored in its own phone book.
- If the unit does not receive Caller ID information, one of the following will be displayed:

Display	Meaning
Out of area	The caller dialed from an area which does not provide Caller ID service.
Private caller	The caller requested not to send his/her information.

- Depending on the radio communications with the base unit, the handset may not display Caller ID information immediately after the ring.
- If your unit is connected to a PBX which does not support Caller ID, you cannot access Caller ID service.
- If the name and the time/date display service is available in your area, the display will show callers' names and the time/date the calls were received. For further information, please contact your telephone company.
- You need to adjust the date and time to show the time and date the calls were received in the Caller List (p. 14).

## Caller ID Service

### Using Talking Caller ID

To use this feature, you need to subscribe to Caller ID. For further information, please contact your telephone company.

To activate this feature, you must turn this feature on (p. 32).

When a call is received, the unit will ring and receive caller information.

If you receive a call from one of the phone numbers stored in the phone book or if the name display service is available in your area, the caller's name will be displayed.

Example

TINA ROBINSON  
15552223333

### Announcing caller information (Talker Caller ID)

If the caller's phone number is stored in the phone book of the extension number 1 handset, all handsets and the base unit will announce the name stored in that phone book (Ex. "Call from TINA ROBINSON") following every ring. If the caller's phone number is not stored in the phone book of the extension number 1 handset, "Number available" is announced, indicating you should look at the display to see who is calling.

- The name announced by the Talking Caller ID feature will be different from the name displayed on the extension number 2 handset if the name is stored differently in each phone book.
- If the unit does not receive Caller ID information, the unit will announce "Call from out of area" or "Call from private caller".
- If the ringer volume of the handsets and base unit is off, caller names will not be announced. The announcement is heard at the handset or base unit ringer volume (p. 17, 18).
- If this feature is turned off, caller names will not be announced (p. 32).
- If an outside call is received while on an intercom call between the handset and base unit, the other handset will ring, but the caller's name will not be announced.
- Name pronunciation may vary.
- The unit will announce each letter of abbreviations, such as "Co." and "Inc.".
- Caller ID supports names of up to 15 letters. If the caller's name has more than 15 letters, the name will not be displayed or announced correctly.
- Your unit may mute one or more rings in order to announce the name of the caller. Talking Caller ID takes precedence over ringing.

## Caller ID Service

---

### To turn Talking Caller ID on or off

You can turn Talking Caller ID on or off for the handset and base unit separately. If this feature is off, the unit will not announce caller names. The factory preset is OFF.

#### Handset Talking Caller ID feature **Handset**

---

1 Press **[MENU]**.

2 Scroll to "Talk Caller ID" by pressing **[▼]** or **[▲]**, then press **Select**.

```
Talk Caller ID
┆Back ▼▲ Select┆
```

3 Select "On" or "Off" by pressing **[▼]** or **[▲]**.

```
Talk Caller ID
:Off
┆Back ▼▲ Save┆
```

4 Press **save**, then press **[OFF]**.

---

#### Base unit Talking Caller ID feature **Handset**

This feature must be turned on or off for the base unit by using the handset.

---

1 Press **[MENU]**.

2 Scroll to "Initial setting" by pressing **[▼]** or **[▲]**, then press **Select**.

```
Initial setting
┆Back ▼▲ Select┆
```

3 Scroll to "Set base unit" by pressing **[▼]** or **[▲]**, then press **Select**.

```
Set base unit
┆Back ▼▲ Select┆
```

4 Scroll to "Talk Caller ID" by pressing **[▼]** or **[▲]**, then press **Select**.

```
Talk Caller ID
┆Back ▼▲ Select┆
```

5 Select "On" or "Off" by pressing **[▼]** or **[▲]**.

```
Talk Caller ID
:Off
┆Back ▼▲ Save┆
```

6 Press **save**, then press **[OFF]**.

---



## Using the Caller List

The unit can record information up to 50 different callers and store this information in the Caller List. Caller information is sorted by the most recent call to the oldest. When the 51<sup>st</sup> call is received, the information from the 1<sup>st</sup> call is deleted.

The unit will also tell you how many calls you missed while you were out or unavailable to answer the phone.

Handset on the base unit or charger

```

    [1]
  2 missed calls
    Charging
  
```

① The display will show the number of calls you missed.

Handset off the base unit or charger

```

  2 missed calls
  Rcvd Phone
  ↓calls book ↓
  
```

② Press **Rcvd calls** to review other calls logged in the Caller List.

- If there are no items in the Caller List, "Rcvd calls" will not be displayed.
- After viewing the missed call entries, "missed calls" will disappear from the display.

- When new messages have been recorded (p. 60), "New message" will be displayed in place of missed calls display.

### Viewing the Caller List **Handset**

**1** Press **Rcvd calls**, **[▼]**, or **[▲]** to enter the Caller List.

Ex. 2 calls missed.

```

  2 missed calls
  Rcvd Phone
  ↓calls book ↓
  
```

```

  2 missed calls
  ▼▲=Scroll list
  ↓All erase
  
```

**2** To search from the most recent call, press **[▼]**.  
To search from the oldest call, press **[▲]**.

**3** Press **[OFF]** to exit the list.

- Each handset has its own Caller List. If you viewed the Caller List or answered a call on one handset, the same information in the other handset will be displayed as "missed".
- If you do not press any buttons for 60 seconds, the unit will exit the Caller List.

## Using the Caller List

- If a call has name information, the caller's name and phone number are alternately displayed as shown on the right in step 2 on page 33.

```
JACK SMITH
3:10P 29JUN.
↓Erase   Select↓
```



```
15553334444
3:10P 29JUN.
↓Erase   Select↓
```

- If an arrow (→) is displayed after the number in step 2 on page 33, the whole phone number will not be shown. Press [\*] to see the remaining numbers or to return to the previous display. Each time you press [\*], the display will change alternately.

```
122233344445555→
3:10P 29JUN.
↓Erase   Select↓
```



```
1222333444455556
666
↓Erase   Select↓
```

### What “√” means

“√” indicates you have already viewed this calling information or answered the call. If the same caller calls again, the call entry with the “√” will be replaced with the new call entry.

```
15553334444
3:10P 29JUN. √
```

### If a caller calls more than once

The number of times the same caller called is displayed (“x2” to “x9”). The date and time of the most recent call will be recorded. After viewing a caller's information, “x2” to “x9” will be replaced with “√”.

Ex. Called 2 times.

```
15553215555
11:20A 12JUN. x2
```

## Calling Back from the Caller List **Handset**

**1** Press **Rcvd calls**, [▼], or [▲] to enter the Caller List.

**2** Scroll to the desired caller by pressing [▼] or [▲].

**3** Press [↶] or [↷].

- The phone number is dialed.

- In some cases, you may have to edit the number before dialing (p. 35).
- If a phone number is not displayed in the caller information, you cannot call that caller back from the Caller List.

## Using the Caller List

### Editing the Caller's Phone Number **Handset**

You can edit a phone number in the Caller List to call it back or store it in the phone book.

- |                                                                                                                                                                                                                                                                                                                                              |                                                                                                      |
|----------------------------------------------------------------------------------------------------------------------------------------------------------------------------------------------------------------------------------------------------------------------------------------------------------------------------------------------|------------------------------------------------------------------------------------------------------|
| <b>1</b> Press <b>Rcvd calls</b> , [▼], or [▲] to enter the Caller List.                                                                                                                                                                                                                                                                     | <pre>2 missed calls Rcvd      Phone ↓calls    book ↓  2 missed calls ▼▲=Scroll list ↓All erase</pre> |
| <b>2</b> Scroll to the desired caller by pressing [▼] or [▲].                                                                                                                                                                                                                                                                                | <pre>15553215555 11:20A 12JAN. ↓Erase   Select↓</pre>                                                |
| <b>3</b> Press <b>Select</b> .                                                                                                                                                                                                                                                                                                               |                                                                                                      |
| <b>4</b> Press <b>Edit</b> .                                                                                                                                                                                                                                                                                                                 | <pre>15553215555 ↓Edit      Save↓</pre>                                                              |
| <b>5</b> Add or erase digits to the beginning of the number as desired. <ul style="list-style-type: none"><li>• To add a digit, enter a number.</li><li>• To erase a digit, press ◀ or [≡].</li></ul>                                                                                                                                        | <pre>115553215555 ↓◀ MENU=Save P↓  0115553215555 ↓◀ MENU=Save P↓</pre>                               |
| <b>6</b> To make a call to the edited number, press [↶] or [☎].<br>To store the edited number in the phone book, press [MENU]. <ul style="list-style-type: none"><li>• If the phone number has no name information when it is stored, continue from (a) under step 4 of “Storing Caller Information in the Phone Book” on page 36.</li></ul> |                                                                                                      |

- The number edited in step 5 will not be maintained in the Caller List.
- You cannot edit a phone number, if the Dial Lock is turned on (p. 54).

#### To quickly add or erase a digit at the beginning of a phone number in the Caller List

1. Follow steps 1 and 2 above.
2. Add or erase digits to the beginning of the number as desired.
  - To add a digit, enter a number.
  - To erase a digit, press [≡].
3. To make a call to the edited number, press [↶] or [☎].  
To store the edited number in the phone book, press [MENU].

## Using the Caller List

### Storing Caller Information in the Phone Book

#### Handset

Caller phone numbers that are in the handset Caller List can be stored in each handset's phone book.

- 1** Press **Rcvd calls**, **[▼]**, or **[▲]** to enter the Caller List.

```
2 missed calls
Rcvd      Phone
↓calls   book ↓
```

```
2 missed calls
▼▲=Scroll list
↓All erase
```

- 2** Scroll to the desired caller by pressing **[▼]** or **[▲]**.

```
15553215555
11:00A 12JAN. x3
↓Erase  Select↓
```

- 3** Press **Select**.

- If the number requires editing, see page 35.

- 4** Press **Save**.

```
15553215555
↓Edit      Save↓
```

- (a) If there is no name information for the caller, "Enter name" will be displayed.

— You can enter a name by performing the following steps:

- (1) enter the name (p. 39),
- (2) press **[▼]**, and
- (3) press **Save**.

— If a name is not required, press **[▼]**, then press **Save**.

- (b) If there is already name information for the caller, the item will be stored.

- To continue storing other items, repeat from step 2.
- To exit programming mode, press **[OFF]**.

```
Enter name
█
▼=Next  ▶↓
```

```
CINDY TURNER
↓◀  ▼=Next  ▶↓
```

- You cannot store Caller List item in the phone book if a phone number is not displayed or the Dial Lock is turned on (p. 54).

## Using the Caller List

### Erasing Caller Information **Handset**

#### To erase a specific caller

<p><b>1</b> Press <b>Rcvd calls</b>, [<b>▼</b>], or [<b>▲</b>] to enter the Caller List.</p>	<div style="border: 1px solid black; padding: 2px;">2 missed calls <b>Rcvd</b> Phone ↓<b>calls</b> book ↓</div> <div style="border: 1px solid black; padding: 2px;">2 missed calls <b>▼▲</b>=Scroll list ↓<b>All erase</b></div>
<p><b>2</b> Scroll to the desired caller by pressing [<b>▼</b>] or [<b>▲</b>], then press <b>Erase</b>.</p> <ul style="list-style-type: none"> <li>• To erase other items, repeat step 2.</li> <li>• To exit the Caller List, press [<b>OFF</b>].</li> </ul>	<div style="border: 1px solid black; padding: 2px;">18887776666 12:20A 12JAN. ↓<b>Erase</b> Select↓</div> <div style="border: 1px solid black; padding: 2px; text-align: center;">Erased</div>

#### To erase all entries

Before erasing all entries, make sure that you have viewed all missed calls.

<p><b>1</b> Press <b>Rcvd calls</b>, [<b>▼</b>], or [<b>▲</b>] to enter the Caller List.</p>	<div style="border: 1px solid black; padding: 2px;">[1] <b>Rcvd</b> Phone ↓<b>calls</b> book ↓</div>
<p><b>2</b> Press <b>All erase</b>.</p>	<div style="border: 1px solid black; padding: 2px;">0 missed call <b>▼▲</b>=Scroll list ↓<b>All erase</b></div>
<p><b>3</b> Press <b>Yes</b>.</p> <ul style="list-style-type: none"> <li>• All entries in your Caller List are erased.</li> </ul>	<div style="border: 1px solid black; padding: 2px;">All erase? ↓<b>No</b> <b>Yes</b>↓</div> <div style="border: 1px solid black; padding: 2px; text-align: center;">All erased</div>

- To cancel erasing, press **No** after step 2.

# Phone Book

The handset can store up to 50 names and phone numbers in its phone book. You can make a call by selecting a name or number from the phone book, and copy phone book items from one handset to another (p. 43–44).

## Storing Names and Numbers Handset

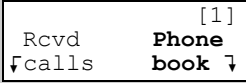
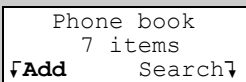
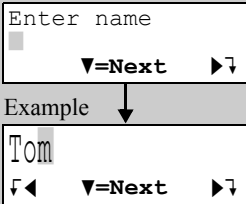
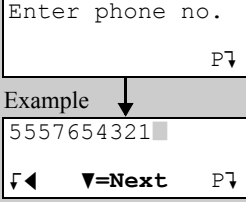
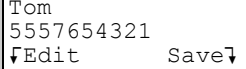
<p><b>1</b> Press <b>Phone book</b>.</p>	
<p><b>2</b> Press <b>Add</b>.</p> <ul style="list-style-type: none"> <li>The display will show the number of stored items.</li> </ul>	
<p><b>3</b> Enter a name of up to 16 characters with the dialing buttons (<b>[0]</b> to <b>[9]</b>) (p. 39), then press <b>[▼]</b>.</p> <ul style="list-style-type: none"> <li>If a name is not required, press <b>[▼]</b> then go to step 4.</li> </ul>	
<p><b>4</b> Enter a phone number of up to 32 digits.</p> <ul style="list-style-type: none"> <li>Each time you press <b>◀</b>, a digit is erased. To erase all of the digits, press and hold <b>◀</b>.</li> <li>If a pause is required when dialing, press <b>P</b>. A pause is stored in a phone number as one digit (p. 52).</li> </ul>	
<p><b>5</b> Press <b>[▼]</b>.</p> <ul style="list-style-type: none"> <li>If you want to change the name, press <b>Edit</b>. The display returns to step 3. Change the name.</li> <li>If you want to change the number, press <b>[▲]</b>. The display returns to step 4. Change the number.</li> </ul>	
<p><b>6</b> Press <b>Save</b>.</p> <ul style="list-style-type: none"> <li>To continue storing other items, repeat from step 2.</li> </ul>	
<p><b>7</b> Press <b>[OFF]</b>.</p>	

When the Dial Lock is turned on (p. 54), only numbers stored in the phone book as emergency numbers can be dialed.

### To store an emergency number:

When storing a name, press **[1]** in step 3 to enter **††** at the beginning of the name (p. 39).

## Phone Book

- To store numbers for calling card access (see “Chain Dial” on page 41), we recommend you add pauses after each item. Storing pauses with numbers will prevent misdialing (p. 52). The delay time necessary will depend on your telephone company.
- You cannot store a name and phone number in the phone book if the Dial Lock is turned on (p. 54).

### Selecting characters to enter names

Enter names using the dialing buttons. Press each button until the desired character is displayed.

- Pressing each button selects a character in the order shown below.

Keys	Characters	Keys	Characters
[1]	# & ' ( ) * , - . / 1	[6]	m n o M N O 6
[2]	a b c A B C 2	[7]	p q r s P Q R S 7
[3]	d e f D E F 3	[8]	t u v T U V 8
[4]	g h i G H I 4	[9]	w x y z W X Y Z 9
[5]	j k l J K L 5	[0]	0 Space
◀	Erases the character to the left.		
▶	Moves the cursor to the right. (To enter another character using the same number key, move the cursor to the next space.)		

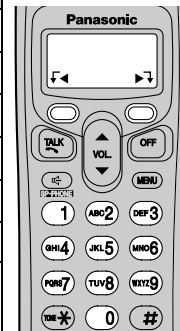

Telephone System

For example, to enter “Tom”:

1 Press [8] four times.	T
2 Press [6] three times, then press ▶ to move the cursor.	To
3 Press [6] once.	Tom

### If you make a mistake when entering a name or number

Use ◀ to erase the incorrect character. Each time you press ◀, a character is erased. Re-enter the correct character. To erase all characters, press and hold ◀.

## Phone Book

### Dialing from the Phone Book **Handset**

1 Press **Phone book**.

2 Press **Search**.

```
Phone book
  7 items
↓Add   Search↓
```

3 Scroll to the desired item. To scroll down, press [▼]. To scroll up, press [▲].

```
0-9=Name search
▼▲=Scroll list
```

Phone book items are sorted in the following order:	
1	Alphabet letters (Alphabetical)
2	Space & ' ( ) , - . /
3	Numbers 0 to 9
4	☐ *
5	Telephone numbers (If no name is stored)

4 Press [↵] or [☎].

- The displayed phone number is dialed.

```
Frank
4445555
↓Erase   Edit↓
```

- If “No items stored” is displayed in step 1, the phone book is empty.
- To exit the phone book, press **[OFF]**.
- To view a phone number over 16 digits long, repeat steps 1 to 3, then press **Edit** and then [▼]. When finished, press **[OFF]**.
- To quickly search the desired item, press [▼] or [▲] after step 1.

#### To search for a name by initial

1. Press **Phone book**.

2. Press **Search**.

3. Press the dialing button for the first letter of the desired name until any name with the same initial is displayed (see the Index on page 41).  
Ex. To find “Frank”, press **[3]** repeatedly until the first item under “F” is displayed.

- If there are no items beginning with the character you selected, the first item in the next alphabetical index will be displayed.

4. Press [▼] repeatedly until the desired name is displayed.



## Phone Book

### Index table

Keys	Index	Keys	Index
[1]	Symbols, 1	[6]	M, N, O, 6
[2]	A, B, C, 2	[7]	P, Q, R, S, 7
[3]	D, E, F, 3	[8]	T, U, V, 8
[4]	G, H, I, 4	[9]	W, X, Y, Z, 9
[5]	J, K, L, 5	[0]	0, Space

### Chain Dial **Handset**

You can dial a combination of phone book or manual key pad entries while making a call. This feature can be used, for example, to first automatically dial a calling card access number that you have stored in the phone book, then manually or automatically dial your PIN and then automatically dial the destination number from the phone book.

Ex. Using a long distance calling card

- To prevent misdialing, we recommend you add pauses where needed when storing numbers. For example, add pauses after a calling card access number and your PIN when storing in the phone book (p. 38).
- Search and dial from phone book: 18000123456 (Calling card access number)
    - The voice guidance may be announced.
  - Search and dial from phone book: 1234 (Calling card PIN)
  - Search and dial from phone book: 15550123456 (Destination number)

#### 1 While you are on a call;

Press **[MENU]**.

#### 2 Search for the desired item by pressing **[▼]** or **[▲]**.

- To search for an item by initial, see page 40.

```
Phone book
▼▲=Scroll list
└Back Search┘
```

#### 3 Press **Call**.

- The phone number is dialed.
- If required, repeat steps 1 to 3 for any remaining numbers.

```
Alan
15550123456
└Back Call┘
```

- If you have rotary or pulse service, you need to press **[\*]** before pressing **[MENU]** in step 1 to change the dialing mode temporarily to tone.

## Phone Book

### Editing an Item in the Phone Book **Handset**

1 Press **Phone book**.

2 Press **Search**.

3 Scroll to the desired item by pressing **[▼]** or **[▲]**, then press **Edit**.  
• To search for the item by initial, see page 40.

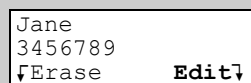

Jane  
3456789  
↵Erase Edit↵

4 Edit the name (p. 39), then press **[▼]**.  
• If you do not need to change the name, press **[▼]** then go to step 5.



Jane Walker  
↵ ◀ ▶ =Next ↵

5 Edit the phone number, then press **[▼]**.  
• If you do not need to change the number, press **[▼]** then go to step 6.  
• Each time you press **◀**, a digit is erased. To erase all of the digits, press and hold **◀**.

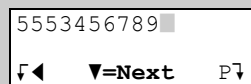

5553456789  
↵ ◀ ▶ =Next P↵

6 Press **Save**.

• To continue editing other items, repeat from step 3.

7 Press **[OFF]**.

• You cannot edit an item, if the Dial Lock is turned on (p. 54).

### Erasing an Item in the Phone Book **Handset**

1 Press **Phone book**.

2 Press **Search**.

3 Scroll to the desired item by pressing **[▼]** or **[▲]**, then press **Erase**.  
• To search for the item by initial, see page 40.

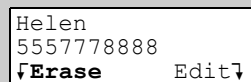

Helen  
5557778888  
↵Erase Edit↵

4 Press **Yes**.  
• To erase other items, repeat from step 3.

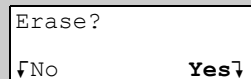

Erase?  
↵No Yes↵

5 Press **[OFF]**.

• To cancel erasing, press **No** after step 3.

• You cannot erase an item, if the Dial Lock is turned on (p. 54).

## Phone Book

### Copying Items in the Phone Book **Handset**

You can copy one or all phone book items between two handsets. The destination handset will save the entries in its phone book.

- If an outside call is received during the phone book copy, copying will stop. You will need to re-send the item(s) later.
- After the copy has started, do not place your handset on the base unit or charger until copying finishes, otherwise copying will stop.

#### To copy one phone book item to another handset

Make sure the destination handset is not in use.

1 Press **[MENU]**.

2 Scroll to “Copy phone book” by pressing **[▼]** or **[▲]**, then press **Select**.

Copy phone book  
↓Back ▼▲ Select↓

3 Press **Select** at “Copy 1 item”.

Copy 1 item  
↓Back ▼▲ Select↓

4 Scroll to the desired phone book item by pressing **[▼]** or **[▲]**, then press **Send**.

- To search for the item by initial, see page 40.
- You can continue by copying to other items.
- The destination handset displays “Phone book Receiving” then “Phone book Received”.

Jane  
3456789  
↓Back ▼▲ Send↓

↓  
Complete

5 Press **[OFF]**.

## Phone Book

---

### To copy all of the items in your phone book to another handset

Make sure the destination handset is not in use.

**1** Press **[MENU]**.

**2** Scroll to “Copy phone book” by pressing **[▼]** or **[▲]**, then press **Select**.



Copy phone book  
↵Back ▼▲ Select↵

**3** Scroll to “Copy all items” by pressing **[▼]** or **[▲]**, then press **Select**.

- When all items have been copied, “Complete” is displayed.
- The destination handset displays “Phone book Receiving” then “Phone book Received”.

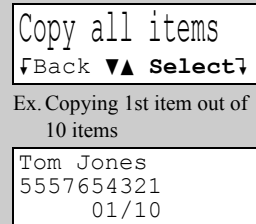

Copy all items  
↵Back ▼▲ Select↵  
Ex. Copying 1st item out of  
10 items  
Tom Jones  
5557654321  
01/10

**4** Press **[OFF]**.

- You can exit phone book copying mode by pressing **[OFF]**.

# Intercom

Intercom calls can be made between the handset and the base unit, and between two handsets. You can page all handsets at once from the base unit, and announce the page to all handsets (**Voice Paging**, page 47).

The handsets have the extension number 1 and 2 which has “[1]” and “[2]” on the display.

- If the handset is off the base unit or charger when there are missed calls or new messages, the handset’s extension number “[1] or “[2]” is not displayed. To confirm the extension number, either place the handset on the base unit or charger, or view the missed calls (p. 33) and listen to the new messages (p. 60).

## Making Intercom Calls

### From **Handset**

**1** Press **[HOLD/INTERCOM]**.

- 2** To page the base unit, press **Base**.  
To page another handset, press **Handset**.
- The paged unit will ring for 1 minute.
  - To stop paging, press **[OFF]**.

Select for  
Intercom  
↓Base Handset↓

Ex. Calling Base unit

Calling Base

Ex. Calling Handset 2

Calling HS[2]

- 3** When the paged party answers, start talking.
- You can switch to the speaker by pressing **[☎]**. To switch back to the receiver, press **[📞]**.

Intercom  
00-00-05  
Mute↓

**4** To disconnect the intercom, press **[OFF]**.

### From **Base Unit**

Using this feature, you can also locate a misplaced handset.

**1** Press **[LOCATOR/INTERCOM]**.

- The SP-PHONE indicator lights.

**2** To page all handsets, press **[0]**.

To page a specified handset, press its extension number **[1]** (**1**) or **[2]** (**2**).

- The handset will ring for 1 minute.
- To stop paging, press **[SP-PHONE]** or **[LOCATOR/INTERCOM]**.

**3** When the paged party answers, talk into the **MIC**.

**4** To disconnect the intercom, press **[SP-PHONE]** or **[LOCATOR/INTERCOM]**.

- The indicator light goes out.

## Intercom

### During an intercom call:

- If you have difficulty hearing while using the handset speakerphone and base unit speaker, decrease the speaker volume by pressing **VOLUME [v]** on the base unit or **[▼]** on the handset.
- If an incoming call is being received, you will hear two tones (incoming call tone, page 53) and "**LINE IN USE**" will flash rapidly on the base unit.  
To answer the call;
  - if using the handset, press **[OFF]**, then **[↶]** or **[↷]**.
  - if using the base unit, press **[SP-PHONE]** twice.

## Answering Intercom Calls

### Handset

When a handset is paged, it rings and the Ringer/Message Alert indicator flashes rapidly. The display shows the calling extension.

#### 1 Press **[↶]**, **[↷]** or **[HOLD/INTERCOM]**.

- You can also answer a call by pressing any button except **[▼]**, **[▲]** or **[OFF]**.

Ex. Base calling

Call from Base

Ex. Handset 2 calling

Call from HS[2]

#### 2 To disconnect the intercom, press **[OFF]**.

- If the Auto Talk feature is turned on (p. 16), you can also answer a page by simply lifting the handset off the base unit or charger.

### Base Unit

When the base unit is being paged, it rings.

#### 1 Press **[SP-PHONE]** or **[LOCATOR/INTERCOM]**.

#### 2 To disconnect the intercom, press **[SP-PHONE]** or **[LOCATOR/INTERCOM]**.

- When the ringer volume is turned off (p. 17, 18), the handset and the base unit will ring at the low level for intercom calls.
- You cannot change the ringer tone for intercom calls.
- When the base unit user pages all handsets, only the handset user who answers first can talk with the base unit user.

### Voice Paging **Base Unit**

The base unit user can make a voice announcement that is heard through the speakers of all handsets.

---

**1** Press **[LOCATOR/INTERCOM]**.

- The SP-PHONE indicator lights.

---

**2** To make a voice announcement to all handsets, press **[3]** (**PAGE**).

- You will hear a ringback tone (two short beeps) and the SP-PHONE indicator flashes.

---

**3** When the SP-PHONE indicator stops flashing, speak into the **MIC**.

- All handset users will hear your voice through their speakers after beeps, and “Call from Base” will be displayed and the Ringer/Message Alert indicator will flash rapidly on the handsets.
- The handset on the base unit will not be paged.

---

**4** When stop paging, press **[SP-PHONE]** or **[LOCATOR/INTERCOM]**.

OR

When one of the handsets answers, talk into the **MIC**.

To disconnect the intercom, press **[SP-PHONE]** or **[LOCATOR/INTERCOM]**.

- 
- Only the handset user who answers first can talk with the base unit user.
  - To answer the page from the handsets, see “Answering Intercom Calls” on page 46.
  - It is not possible to specify which handset will hear the voice announcement.
  - If a handset is too close to the base unit, you may hear feedback while making the voice announcement.  
Place the handset on the base unit or charger or press **[OFF]**.
  - The announcement is heard at the handset ringer volume (p. 17).

## Transferring a Call

You can transfer an outside call to the base unit or the handset.

### From the **Handset** to the **Base Unit**

#### 1 Handset:

(1) During a call, press **[HOLD/INTERCOM]**.

- The call is put on hold.

(2) Press **Base**.

(3) Wait for the paged party to answer, then you can announce the transfer.

- After the paged party answers, "Intercom hold" is displayed.
- If the paged party does not answer, press **[↶]** or **[↷]** to return to the outside call.

Line on hold.  
Transfer to  
↓**Base** Handset↓

Hold  
Calling Base

#### 2 Base unit:

Press **[SP-PHONE]** or **[LOCATOR/INTERCOM]** to answer the page.

#### 3 Handset: To complete the transfer, press **[OFF]**.

### From the **Base Unit** to the **Handset**

#### 1 Base unit:

(1) During a call, press **[LOCATOR/INTERCOM]**.

- The call is put on hold.

(2) To page a specified handset, press its extension number **[1]** (**↷**) or **[2]** (**↶**).

To page all handsets, press **[0]**.

After the handset user answers, announce the transfer.

OR

To make a voice announcement to all handsets, press **[3]** (**↷**), then speak into the **MIC** when the SP-PHONE indicator stops flashing.

- If the paged party does not answer, press **[LOCATOR/INTERCOM]** to return to the outside call.

#### 2 Handset:

Press **[↶]**, **[↷]** or **[HOLD/INTERCOM]** to answer the page.

- You can also answer a call by pressing any button except **[▼]**, **[▲]** or **[OFF]**.

#### 3 Base unit: To complete the transfer, press **[SP-PHONE]**.

- When the base unit user calls all handsets, only the handset user who answers first can take the transferred call.



## Transferring a Call

### From a **Handset** to another **Handset**

- 1 During a call, press **[HOLD/INTERCOM]**, then page another handset by pressing **Handset**.
- 2 Wait for the paged party to answer, then you can announce the transfer.
  - After the paged party answers, “Intercom hold” is displayed.
  - The paged handset user can answer by pressing **[↶]**, **[⇨]** or **[HOLD/INTERCOM]**. (Any button except **[▼]**, **[▲]** or **[OFF]** can be pressed to answer the page.)
  - If the paged party does not answer, press **[↶]** or **[⇨]** to return to the outside call.
- 3 To complete the transfer, press **[OFF]**.
  - If the Auto Talk feature is turned on (p. 16), the paged handset user can also answer a page by simply lifting the handset off the base unit or the charger.
  - Any user can answer a transferred call by pressing **[↶]**, **[⇨]** or **[SP-PHONE]**.

### Quick call transfer

You can transfer a call without waiting for the paged party to answer.

#### **Handset**

- 1 During a call, press **[HOLD/INTERCOM]**, then press **Base** or **Handset**.
- 2 Press **[OFF]** to hang up.

#### **Base Unit**

- 1 During a call, press **[LOCATOR/INTERCOM]**.
- 2 Press the extension number **[1]** (**/**) or **[2]** (**/**) or press **[0]** to page all handsets.
- 3 Press **[SP-PHONE]** to hang up.
  - The call will be transferred directly.
  - The paged party can answer the transferred call by pressing **[↶]**, **[⇨]** or **[SP-PHONE]**.
  - After the paged party answers, the transfer is complete.
  - If the paged party does not answer:
    - for the handset, press **[↶]** or **[⇨]** to return to the outside call.
    - for the base unit, press **[SP-PHONE]** to return to the outside call.
  - If the paged party does not answer within 60 seconds after you hang up, your phone will ring and the call will be returned to your phone. You may speak to the caller again by pressing **[↶]**, **[⇨]** or **[SP-PHONE]**.
  - If you do not answer the call within 4 minutes, the call will be disconnected.

## Conference Calls

---

While you are talking with an outside caller, the base unit user or a handset user can join the conversation and establish a conference call.

### Handset

- 1 During a call, press **[HOLD/INTERCOM]**.
  - The call is put on hold.
- 2 To page the base unit, press **Base**.  
To page another handset, press **Handset**.
- 3 When the paged party answers, press **CONF** on your unit to make a conference call.
  - “Conference” is displayed during a conference call.

### Base Unit

- 1 During a call, press **[LOCATOR/INTERCOM]**.
  - The call is put on hold.
- 2 To page a handset, press the extension number **[1]** (**1**) or **[2]** (**2**).
- 3 When the paged party answers, press **[HOLD/CONF]** on your unit to make a conference call.

- To leave the conference, press **[OFF]** on the handset or press **[SP-PHONE]** on the base unit. The two other parties can continue the conversation.
- During a conference, the outside call can be placed on hold by pressing **[HOLD/INTERCOM]** on the handset or **[HOLD/CONF]** on the base unit. Internal communications are not suspended. Only the person who placed the call on hold can resume the full conference by pressing **CONF** on the handset or **[HOLD/CONF]** on the base unit.

## Call Share

This feature allows the base unit or the handset to join an existing outside call.

### To join a conversation (Call Share)

#### Handset

- Press **[↶]** or **[📞]**.
- “Conference” is displayed.

#### Base Unit

- Press **[SP-PHONE]**.

## Special Features

### Temporary Tone Dialing

(For Rotary or Pulse Service Users) **Handset** **Base Unit**

Press [**\***] (TONE) before entering access numbers which require tone dialing.

- The dialing mode changes to tone. You can enter numbers to access an answering service, electronic banking service, etc. When you hang up, the dialing mode will return to pulse.

### Muting Your Conversation

During a call, you can mute your phone so the other party cannot listen to you. When muting your conversation, you can hear the other party.

#### **Handset**

Press **Mute**.

- “Mute” will flash.
- **To release the mute**, press **Mute** again.
- If you press [**↔**] or [**↔**] to switch between the receiver and speaker, the mute will be released.

Talk
00-00-30
f (VE) <b>Mute</b>

#### **Base Unit**

Press [**MUTE**].

- The SP-PHONE indicator flashes.
- **To release the mute**, press [**MUTE**] again.

Telephone System

### For Call Waiting Service Users

**Handset** **Base Unit**

Press [**FLASH/CALL WAIT**] if you hear a call waiting tone during a conversation.

- The first call is put on hold and you can answer the second call.
- To return to the first caller, press [**FLASH/CALL WAIT**] again.
- Call Waiting service cannot be used when the first call is put on hold, or the Answering System is handling a call.
- If this function does not operate properly, consult your telephone company for details.

## Special Features

### Using the PAUSE Key

#### (For PBX Line/Long Distance Calls) **Handset**

We recommend you press **Pause** or **P** if a pause is required for dial with a PBX or to make a long distance call.

Ex. Line access number **[9]** (PBX)

**[9]** ➔ **Pause** or **P** ➔

- Pressing **Pause** or **P** once creates a 3.5 second pause. This prevents misdialing when you dial after confirming the entered number (p. 26) or dial a stored number (p. 40, 41).
- Pressing **Pause** or **P** more than once increases the length of the pause between numbers.

Example

9P15556667777  
 ↵Clear      Pause↵

OR

9P15551234567  
 ↵◀      ▼=Next      P↵

#### **FLASH Button** **Handset** **Base Unit**

Pressing **[FLASH/CALL WAIT]** allows you to use special features of your host PBX such as transferring an extension call, or accessing optional telephone services such as call waiting.

- Pressing **[FLASH/CALL WAIT]** cancels Temporary Tone Dialing mode or the mute (p. 51).

#### Selecting the flash time **Handset**

The flash time required depends on your telephone exchange or host PBX. You can select the following flash times: “700, 600, 400, 300, 250, 110, 100 or 90 ms (milliseconds)”. The factory preset is “700 ms”.

- If PBX functions do not work correctly, consult your PBX supplier for the correct settings.

**1** Press **[MENU]**.

**2** Scroll to “Initial setting” by pressing **[▼]** or **[▲]**, then press **Select**.

Initial setting  
 ↵Back ▼▲ Select↵

**3** Scroll to “Set tel line” by pressing **[▼]** or **[▲]**, then press **Select**.

Set tel line  
 ↵Back ▼▲ Select↵

**4** Scroll to “Set flash time” by pressing **[▼]** or **[▲]**, then press **Select**.

Set flash time  
 ↵Back ▼▲ Select↵

**5** Select the desired time by pressing **[▼]** or **[▲]**.

Set flash time  
 :700ms  
 ↵Back ▼▲ Save↵

**6** Press **save**, then press **[OFF]**.

## Special Features

### Incoming Call Tone **Handset** **Base Unit**

During an intercom call (p. 45), you can be informed of incoming calls by two tones. If this feature is turned on, incoming call tones will be heard for as long as the line is ringing. If this feature is set to "2", incoming call tones will be heard only 2 times. If this feature is turned off, no tones will be heard. The factory preset is "2". Using the handset, this feature can be set separately for the handset and base unit.

#### Handset incoming call tone **Handset**

1 Press **[MENU]**.

2 Scroll to "Ringer setting" by pressing **[▼]** or **[▲]**, then press **Select**.

```
Ringer setting
┆Back ▼▲ Select┆
```

3 Scroll to "Incoming call." by pressing **[▼]** or **[▲]**, then press **Select**.

```
Incoming call.
┆Back ▼▲ Select┆
```

4 Select "On", "Off" or "2" by pressing **[▼]** or **[▲]**.

```
Incoming call
tone :2
┆Back ▼▲ Save┆
```

5 Press **save**, then press **[OFF]**.

#### Base unit incoming call tone **Handset**

1 Press **[MENU]**.

2 Scroll to "Initial setting" by pressing **[▼]** or **[▲]**, then press **Select**.

```
Initial setting
┆Back ▼▲ Select┆
```

3 Scroll to "Set base unit" by pressing **[▼]** or **[▲]**, then press **Select**.

```
Set base unit
┆Back ▼▲ Select┆
```

4 Scroll to "Incoming call." by pressing **[▼]** or **[▲]**, then press **Select**.

```
Incoming call.
┆Back ▼▲ Select┆
```

5 Select "On", "Off" or "2" by pressing **[▼]** or **[▲]**.

```
Incoming call
tone :2
┆Back ▼▲ Save┆
```

6 Press **save**, then press **[OFF]**.

## Special Features

### Key Tone **Handset**

You can select whether or not the handset keys will sound tones (key tone, confirmation tone, error tone). The factory preset is ON.

1 Press **[MENU]**.

2 Scroll to "Initial setting" by pressing **[▼]** or **[▲]**, then press **Select**.

```
Initial setting
┆Back ▼▲ Select┆
```

3 Scroll to "Key tone" by pressing **[▼]** or **[▲]**, then press **Select**.

```
Key tone
┆Back ▼▲ Select┆
```

4 Select "Off" or "On" by pressing **[▼]** or **[▲]**.

```
Key tone
:On
┆Back ▼▲ Save┆
```

5 Press **save**, then press **[OFF]**.

### Dial Lock **Handset**

The Dial Lock feature allows you to prevent others from making calls with the handset and base unit. To use this feature, turn the feature on. The factory preset is OFF.

When the Dial Lock is turned on, only numbers stored in the phone book as emergency numbers (numbers stored with a **†** at the beginning of the name) can be dialed (p. 38). We recommend storing emergency numbers in the phone book before using this feature.

### To turn the Dial Lock on

1 Press **[MENU]**.

2 Scroll to "Dial lock" by pressing **[▼]** or **[▲]**, then press **Select**.

```
Dial lock
┆Back ▼▲ Select┆
```

3 Enter a 4-digit password.

- This password is required when canceling the Dial Lock.
- If more than 4 digits are entered, the last 4 digits are the password.

```
Enter password
:----
┆Back
```

4 Press **save**.

```
Enter password
:1234
┆Back Save┆
```

## Special Features

### 5 Press **Yes**, then press **[OFF]**.

- “Dial lock on” is displayed.

```
Turn Dial lock
on?
└Back      Yes└
```

- If the Dial Lock is turned on, the handset displays “Dial lock” while there are not missed calls and new messages, and the handset is off the base unit.

- If you make a call while the Dial Lock is turned on:
  - using the handset, the handset beeps 3 times and “Dial locked” is displayed.
  - using the base unit, the base unit beeps 3 times.
- Please write down your password. If you forget your password, consult your nearest Panasonic service center.

### To cancel the Dial Lock

#### 1 Press **[MENU]**.

#### 2 Scroll to “Dial lock” by pressing **[▼]** or **[▲]**, then press **Select**.

```
Dial lock
└Back ▼▲ Select└
```

#### 3 Enter the password set when the Dial Lock was turned on.

```
Enter password
:
└Back
```

#### 4 Press **Save**.

```
Enter password
:****
└Back      Save└
```

#### 5 Press **Yes**, then press **[OFF]**.

- “Dial lock off” is displayed.
- If you entered the wrong password, the handset beeps 3 times and “Save error” is displayed. Enter the correct password.

```
Turn Dial lock
off?
└Back      Yes└
```

## Special Features

### Re-registering the Handset **Handset & Base Unit**

If “No link to base. Move closer to base, try again.” is displayed even when using the handset near the base unit, the handset may have lost communication with the base unit. You need to re-register the handset to the base unit.

- **Make sure the base unit is not being used.**
- **Have both handsets and base unit nearby during registration.**
- **Follow steps 1–3 listed below. You have about 1 minute to complete them.**
- **Confirm the extension number of the handset which has lost the communication by placing the handset on the base unit or charger.**

If you re-register the handset using the other handset’s extension number, the other handset will not function.

**1 Base unit:** Press and hold **[LOCATOR/INTERCOM]** until a beep sounds.

- The CHARGE indicator flashes.

**2 Base unit:** Press the extension number **[1]** (**1**) or **[2]** (**2**) of the handset which has lost the communication.

**3 Handset:** Press and hold **[FLASH/CALL WAIT]** until “Handset Registering” is displayed.

- When registration is complete, a beep sounds from the handset and the display shows the number.
- **Wait for 20 seconds after registration is complete while the handset establishes communication with the base unit.**

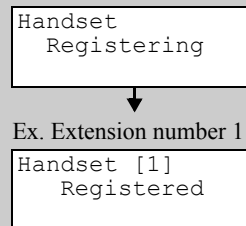

- If the handset beeps 3 times and “Error!!” is displayed, an error occurred. Try again from step 1.
- You can stop registration by pressing **[OFF]** on the handset, and pressing **[LOCATOR/INTERCOM]** on the base unit.



## Automatic Answering Operation

When the unit answers a call, a greeting message is played and the caller's message is recorded.

- The total recording time of all messages (greeting, incoming and memo) is **about 16 minutes** (about 8 minutes in "Enhanced recording" mode, p. 24). If messages are recorded in noisy rooms, the time may be shortened by up to 3 minutes.
- To select the caller's recording time, see page 22.
- A maximum of 64 messages (including greeting and memo message) can be recorded.

### Setting the Unit to Answer Calls **Base Unit**

Press **[ANSWER ON]** to turn on the Answering System.

- The indicator lights and the unit announces "Answer set" and current day and time. If "Answer set. Set time" is heard, set the date and time (p. 14).
- The unit will announce the remaining recording time if it is less than 3 minutes.
- When no recording time is available, you will need to erase any unnecessary messages before new messages can be recorded (p. 62). The unit can indicate that memory is full in the following ways:
  - "**FULL**" will flash on the base unit and the ANSWER ON indicator will flash rapidly until you erase a message.
  - The unit will announce "Memory full" when you press **[ANSWER ON]**, **[GREETING REC]**, or **[MEMO]**, and after playing back messages or recording a message.
- If you do not want the unit to answer calls, press **[ANSWER ON]** again to turn off the Answering System. The indicator light goes out and "Answer off" is heard.
- You can also turn on the Answering System remotely from an outside phone (p. 66).

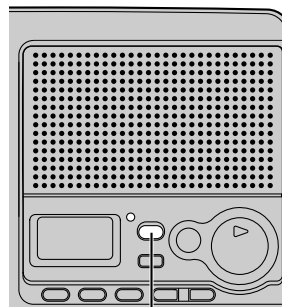

**[ANSWER ON]** and Indicator

Answering System

### **Handset**

- 1** Press **[MENU]**.
- 2** Press **select** at "Message play".
- 3** Press **[8]** to turn on the Answering System.
  - "Answer set" is heard.
- 4** Press **[OFF]**.

- To turn the Answering System off, press **[0]** in step 3. "Answer off" is heard.

## Automatic Answering Operation

---

### Monitoring Incoming Calls **Base Unit**

While a caller is leaving a message, you can monitor the call through the base unit speaker.

- To increase the speaker volume while monitoring, press **VOLUME** [**^**]. To decrease the volume, press **VOLUME** [**v**].

To answer a call while monitoring, press [**SP-PHONE**] on the base unit or press [**↶**] or [**↵**] on the handset.

#### To turn the incoming call monitoring feature off

When the base unit is not in use, press [**GREETING CHECK**], then press **VOLUME** [**v**] repeatedly until “0” is displayed. (Make sure the Answering System is turned on.)

OR

While monitoring, press **VOLUME** [**v**] repeatedly until “0” is displayed.

- If the incoming call monitoring feature is turned off, it will remain off when the next call is monitored.
- If you adjust the speaker volume while playing back messages or using the speakerphone, the speaker volume for monitoring will be turned on again. To turn the speaker volume off, see “To turn the incoming call monitoring feature off” of above step.

## Listening to Messages

**Voice Day/Time Stamp:** During playback, the unit will announce the day and time when each message was recorded (p. 14).

### Using the Base Unit **Base Unit**

You can see the total number of recorded messages on the base unit display. If the NEW MESSAGE indicator flashes on the base unit, new messages have been recorded.

- If the Message Alert is turned on (p. 24), the Ringer/Message Alert indicator on the handset will flash slowly when new messages have been recorded and the handset is not in use.

### To play back messages

Press **[MESSAGE]**.

- The unit announces the number of new messages and only new messages are played back.
- When you have no new messages, the unit announces “No new messages. All message playback” and plays back all messages.
- When you have no messages, the unit announces “No messages”.

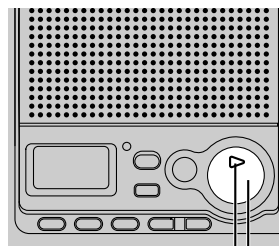

NEW MESSAGE Indicator

**[MESSAGE]**

- During playback, the display shows the message number.
- At the end of the last message, “End of final message” is heard. The unit will announce the remaining recording time if it is less than 3 minutes.
- If a call is received during playback, the unit rings and playback stops. To answer the call, press **[SP-PHONE]**. For playback, start again from the beginning after hanging up.

Answering System

## Listening to Messages

### Using the Handset (Remote Operation) **Handset**

If “New message” is displayed on the handset, new messages have been recorded.

- If the Message Alert is turned on (p. 24), the Ringer/Message Alert indicator on the handset will flash slowly when new messages have been recorded and the handset is not in use.

### To play back messages

**1** Press **[MENU]**.

**2** Press **select** at “Message play”.

- The unit announces the number of new messages and only new messages are played back from the speaker. To switch to the receiver, press **[↶]**. To switch back to the speaker, press **[↷]**.
- When you have no new messages, the unit announces “No new messages. All message playback” and plays back all messages.
- When you have no messages, the unit announces “No messages”.
- To play all messages, press **[5]**.
- If you do not press any button, the voice menu will start (see below).



Message play  
↶Back ▼▲ Select↷

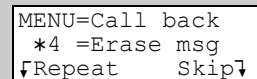

MENU=Call back  
\*4 =Erase msg  
↶Repeat Skip↷

**3** To end remote operation, press **[OFF]**.

- If a call is received during playback, the unit rings and playback stops. To answer the call, press **[↶]** or **[↷]**. For playback, start again from the beginning after hanging up.
- At the end of the last message, “End of final message” is heard. The unit will announce the remaining recording time if it is less than 3 minutes.
- If you hear “Memory full” after playback, erase unnecessary messages (p. 62).
- When memo messages are played (p. 63), “MEMO” is displayed.

#### Voice menu

If you do not press any buttons at the end of the last message, the unit will announce “End of final message” and the voice menu will begin.

The unit announces, “Press 4 to play back new messages. Press 5 to play back all messages.”

- You can press buttons for other playback options (p. 61) even if the voice menu has started.
- If you do not press any button within 10 seconds after the voice menu, the handset will exit remote operation.

## Listening to Messages

### For Caller ID service users (p. 30)

During playback using the handset, the handset display will show the number of the caller whose message is being played.

#### To call back the displayed number:

1. During playback, press **[MENU]**.

5557778888	
↓Repeat	Skip↓

2. Press **Call**, [**↶**] or [**📞**].

5557778888	
↓Edit	Call↓

- The unit stops playback and dials the phone number.
- If you need to edit the phone number to call back, see page 35.
- You cannot call back, if the Dial Lock is turned on (p. 54).

### During playback **Base Unit** **Handset**

<b>To adjust the speaker volume</b>	<p><i>Base unit:</i> To increase volume, press <b>VOLUME [^]</b>. To decrease volume, press <b>VOLUME [v]</b>.</p> <p><i>Handset:</i> To increase volume, press <b>[▲]</b>. To decrease volume, press <b>[▼]</b>.</p> <ul style="list-style-type: none"> <li>• You can also adjust the receiver volume on the handset.</li> </ul>
<b>To repeat a message</b>	<p><i>Base unit:</i> Press <b>[REPEAT]</b>.</p> <p><i>Handset:</i> Press <b>Repeat</b> or <b>[1]</b>.</p> <ul style="list-style-type: none"> <li>• If pressed within the first 5 seconds of playback, the previous message will be played.</li> </ul>
<b>To skip a message</b>	<p><i>Base unit:</i> Press <b>[SKIP]</b>.</p> <p><i>Handset:</i> Press <b>Skip</b> or <b>[2]</b>.</p>
<b>To stop playback</b>	<p><i>Base unit:</i> Press <b>[STOP]</b>.</p> <ul style="list-style-type: none"> <li>• To resume playback, press <b>[MESSAGE]</b>.</li> <li>• If you do not press any button for 60 seconds or if you press <b>[STOP]</b> again, playback mode will be canceled.</li> </ul> <p><i>Handset:</i> Press <b>[9]</b>.</p> <ul style="list-style-type: none"> <li>• If you do not press any button within 15 seconds after stopping playback, the voice menu will start (p. 60).</li> </ul>

## Erasing Messages

The unit will announce the remaining recording time after playback if it is less than 3 minutes.

New messages cannot be recorded when:

- “Memory full” is heard.
- “**FULL**” flashes on the base unit.
- the ANSWER ON indicator flashes rapidly (when the Answering System is on).

Erase unnecessary messages. We recommend you erase unnecessary messages after each playback.

### Erasing a specific message

#### Base Unit

Press **[ERASE]** while the message you want to erase is being played.

- The unit beeps, then plays back the next message.
- To exit playback mode, press **[STOP]** twice.

#### Handset

Press **[\*] [4]** while the message you want to erase is being played.

- The unit beeps, then plays back the next message.
- To exit remote operation mode, press **[OFF]**.

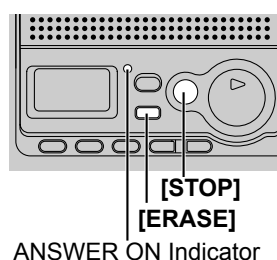

### Erasing all messages

All recorded messages, except the greeting message, can be erased at one time.

#### Base Unit

**1** Press **[ERASE]** while the base unit is not being used.

- “To erase all messages, press ERASE again” is heard.

**2** Within 10 seconds, press **[ERASE]** again.

- The unit beeps, then announces “No messages”.
- The base unit display shows “0”.

#### Handset

**1** Press **[MENU]**.

**2** Press **select** at “Message play”.

**3** Press **[\*] [5]**.

- The unit beeps, then announces “No messages”.
- To end remote operation, press **[OFF]**.

• Information in the Caller List will not be erased. To erase caller information, see page 37.

## Recording a Memo Message

### Base Unit

You can record a voice memo message of up to 3 minutes in memory.

- 1** Press **[MEMO]**.
- 2** After the long beep, talk clearly 20 cm away from the **MIC**.
  - The base unit display shows the elapsed recording time.
  - If the elapsed recording time exceeds 99 seconds, the counter continues from 00 to indicate 100 seconds.
- 3** When finished, press **[MEMO]** or **[STOP]**.
  - The NEW MESSAGE indicator flashes.

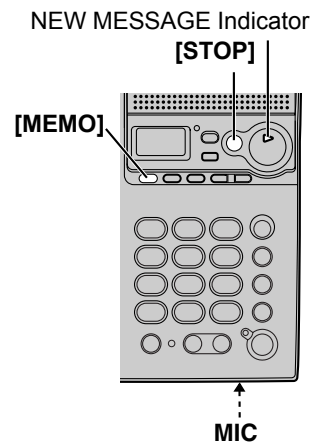

- If you record for over 3 minutes in step 2, the unit will stop recording.
- If "E" is displayed, 6 beeps sound and "Your message was not recorded. Record your message again." is announced, start again from step 1.

## Remote Operation from a Touch Tone Phone

While outside, you can operate the Answering System from any touch tone phone. A synthesized voice menu will guide you through the Answering System (p. 65).

- To skip the voice menu and operate the unit directly, see page 66.

### Summary of remote operation

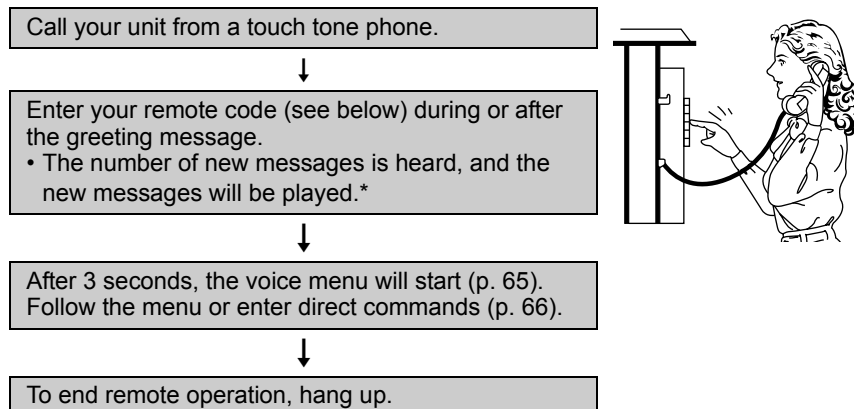

- The unit will announce the remaining recording time after playback if it is less than 3 minutes.
- The messages are saved.

\* If “No new messages” is announced, the unit has only old messages.  
If “No messages” is announced, the unit has no messages.

### Remote Code **Handset**

The remote code prevents unauthorized people from accessing your unit and listening to your messages. Choose any **2-digit number (00–99)** for your remote code. The factory preset remote code is “11”. If you do not program your own remote code, you can use “11”.

- 1 Press **[MENU]**.
- 2 Scroll to “Initial setting” by pressing **[▼]** or **[▲]**, then press **Select**.
- 3 Press **Select** at “Set answering”.

```

Set answering
┆Back ▼▲ Select┆
  
```

- 4 Scroll to “Remote code” by pressing **[▼]** or **[▲]**, then press **Select**.

```

Remote code
┆Back ▼▲ Select┆
  
```

- 5 Enter a **2-digit remote code (00–99)**.

```

Remote code
:11
┆Back      Save┆
  
```

- 6 Press **Save**, then press **[OFF]**.

**To confirm the remote code**, repeat steps 1 to 4.

- The remote code is displayed. When finished, press **[OFF]**.



## Remote Operation from a Touch Tone Phone

### Voice Menu

The shaded parts are voice prompts.

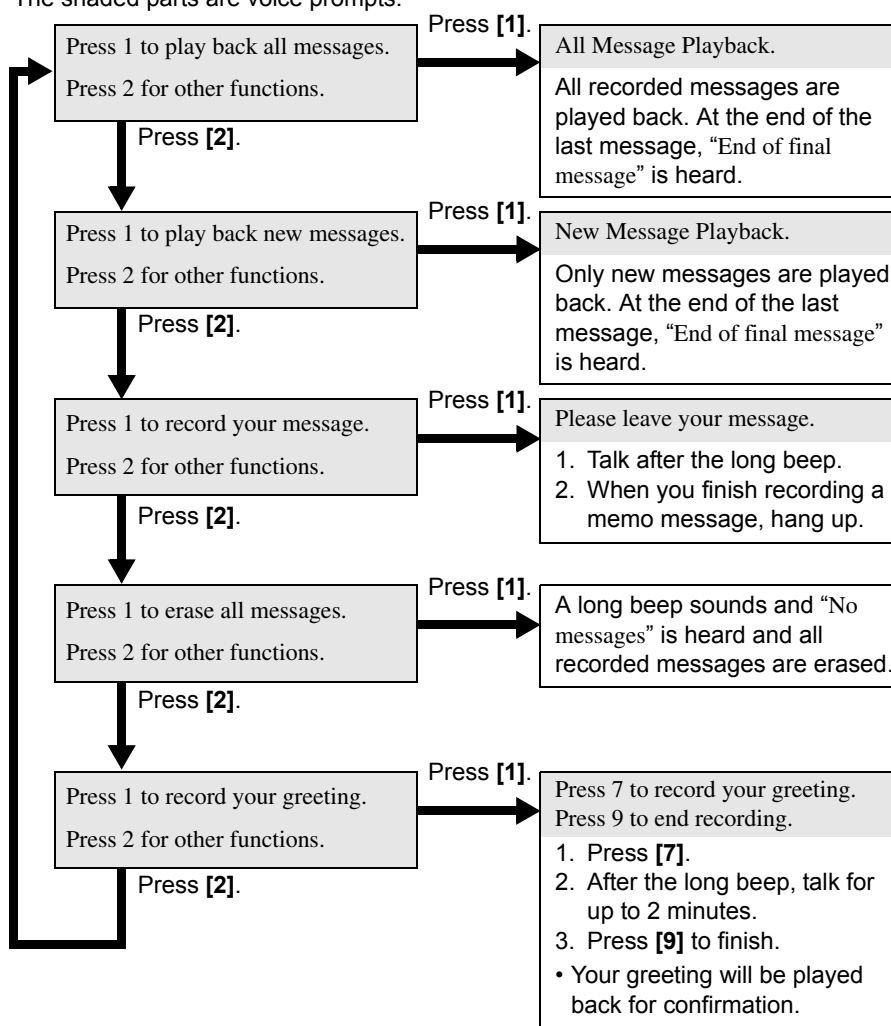

Answering System

- 3 seconds after playback, the voice menu will start again from the beginning.
- The unit will announce the remaining recording time after playback if it is less than 3 minutes.
- If you hear "Memory full" after playback, erase unnecessary messages (p. 66).
- If you do not press any buttons within 10 seconds after a voice prompt, "Thank you for your call." will be heard and the call will be disconnected.

## Remote Operation from a Touch Tone Phone

---

### Direct Remote Operation

Once you have entered the remote code, you can also control your unit by direct commands instead of using the voice menu. To end remote operation, hang up at anytime.

#### Direct commands

<b>[4]</b> :	Plays back new messages.	<b>[7]</b> :	Records a greeting message. After the long beep, talk for up to 2 minutes.
<b>[5]</b> :	Plays back all messages.		
<b>[1]</b> :	Repeats the current message. • If pressed within the first 5 seconds of playback, the previous message will be played.	<b>[9]</b>	Recording is stopped. • The greeting is played.
<b>[2]</b> :	Skips the current message.	<b>[*] [4]</b> :	Erases the current message. • A short beep will sound and the next message will be played.
<b>[9]</b> :	Stops the current operation. • To resume, enter a direct command within 15 seconds, or the voice menu will start (p. 65).	<b>[*] [5]</b> :	Erases all messages. • A long beep will sound and “No messages” will be heard.
		<b>[0]</b> :	Turns off the Answering System. • The unit hangs up.

#### To turn on the Answering System:

Call your unit and wait for 15 rings.

- The unit will answer and the greeting will be played.
- The Answering System will be turned on. Hang up or enter the remote code for other options.
- When turning on the Answering System using a rotary or pulse service telephone, you cannot enter the remote code for other options.

#### Skipping the greeting

After calling your unit, press [\*] during the greeting.

- The unit skips the rest of the greeting and you can start recording your message after the long beep.

## Belt Clip

---

You can hang the handset on your belt or pocket using the included belt clip.

### To attach the belt clip

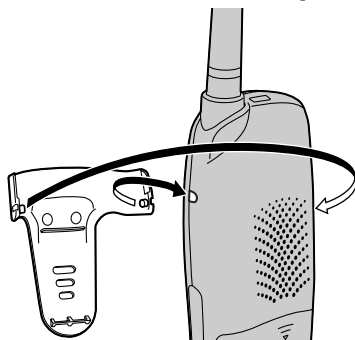

### To remove the belt clip

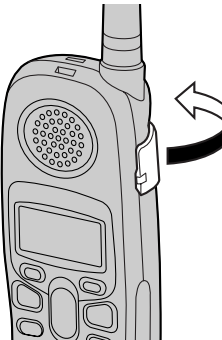

## Optional Headset

---

Connecting an optional headset to the handset allows hands-free phone conversation. Please use only the Panasonic KX-TCA89BX headset.

### Connecting the optional headset

Open the headset jack cover, and insert the headset plug into the headset jack as shown below.

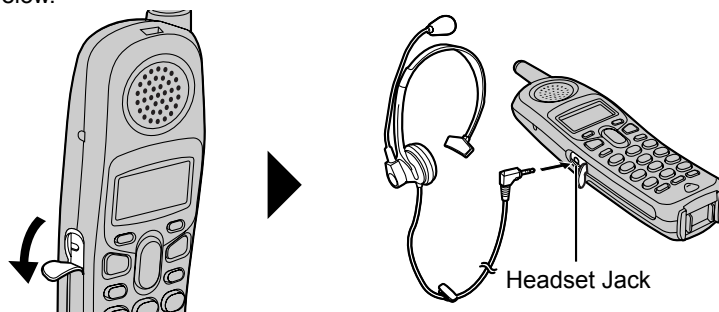

**To switch to the speakerphone while using the headset:**  
Press [☎]. To return to the headset, press [↶].

# Wall Mounting

This unit can be mounted on a wall.

## Base unit

- 1 Push the hook and turn it upward. Turn the hook until a click is heard.

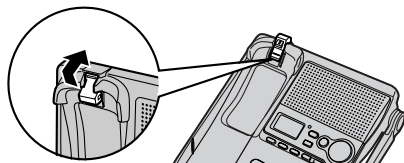

- 2 Press the tabs in the direction of the arrows (1), then remove the wall mounting adaptor (2).

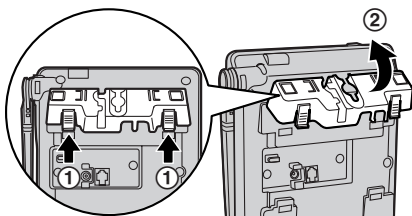

- 3 Connect the AC adaptor. Tuck the telephone line cord inside the wall mounting adaptor, then push the adaptor in the direction of the arrows (1 and 2).

- The word "UP WALL" should face upward.
- Fasten the AC adaptor cord to prevent it from being disconnected.

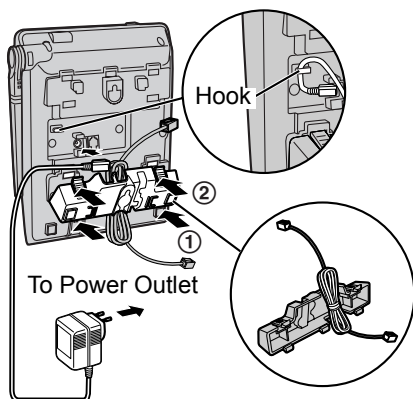

Wall Template

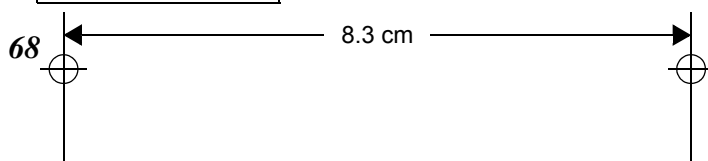

- 4 Install screws using the wall template below. Connect the telephone line cord. Mount the unit, then slide it down.

- Raise the antenna.

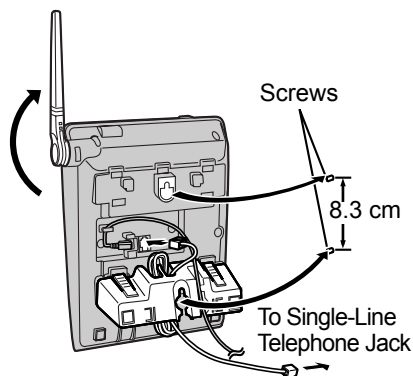

- 5 To charge the handset battery:

Rest the handset on the charge contacts (1), then push the top of the handset so the hook snaps into the slot at the top of the handset (2).

- The unit beeps once and the CHARGE indicator lights.

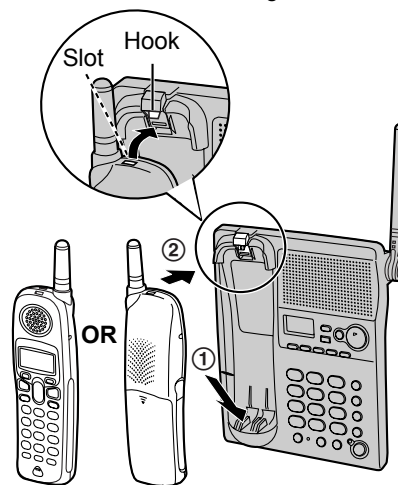

## Wall Mounting

### Charger unit

The charger can be wall mounted. Connect the AC adaptor. Install screws using the wall template (see below). Mount the charger (①). Slide it down (②), then slide it down to the right (③) until it is secured.

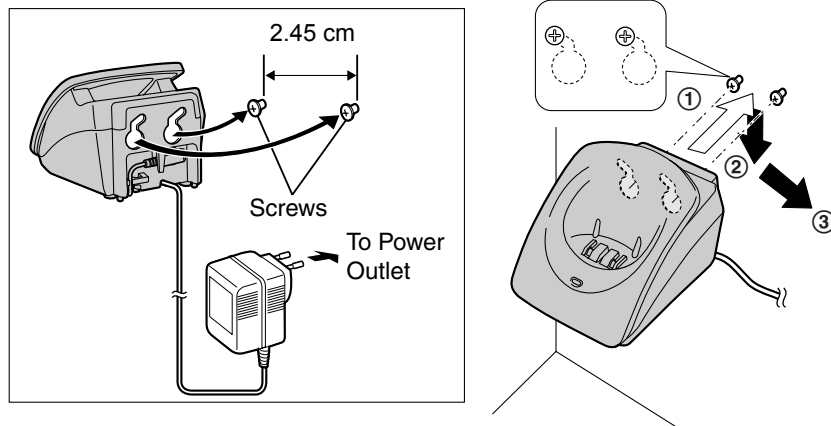

Wall Template for the Charger unit

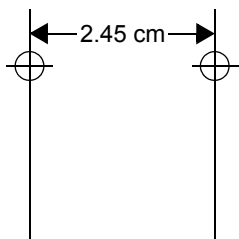

## Direct Commands

### Handset

After pressing [MENU], you can also program menu items directly by pressing [0] to [9], [\*] and [#] instead of using the soft keys.

Menu item	Command	Selection items	Page
Ringer volume	[1] [1]	[0] : Off [1] : Low [2] : Medium [3] : High	p. 17
Ringer tone (for handset)	[1] [2]	[1]–[3] : Tone pattern 1–3 [4]–[7] : Melody pattern 1–4	p. 18
Incoming call tone (for handset)	[1] [3]	[1] : On [2] : Twice [0] : Off	p. 53
Message play	[2]		p. 60
Date and time	[4]	Go to Step 3 on page 14.	—
Voice enhancer	[5]	[1] : On [0] : Off	p. 27
Dial lock	[6]	Go to Step 3 on page 54.	—
Talking Caller ID (for handset)	[9]	[1] : On [0] : Off	p. 32
Copy phone book –Copy 1 item	[#] [1]	Go to Step 4 on page 43.	—
Copy phone book –Copy all items	[#] [2]		p. 44
LCD contrast	[0] [1]	[1]–[6] : Level 1–6	p. 20
Key tone	[0] [2]	[1] : On [0] : Off	p. 54
Auto talk	[0] [3]	[1] : On [0] : Off	p. 16
Set dial mode	[0] [5] [1]	[1] : Pulse [2] : Tone	p. 15
Set flash time	[0] [5] [2]	[1] : 700 ms [2] : 600 ms [3] : 400 ms [4] : 300 ms [5] : 250 ms [6] : 110 ms [7] : 100 ms [8] : 90 ms	p. 52
Set line mode	[0] [5] [3]	[1] : A [2] : B	p. 16
Number of rings	[0] [6] [1]	[2]–[7] : 2–7 rings [0] : Toll saver	p. 23

## Direct Commands

Menu item	Command	Selection items	Page
Recording time	[0] [6] [2]	[1] : 1 minute    [2] : 2 minutes [3] : 3 minutes [0] : Greeting only	p. 22
Remote code	[0] [6] [3]	Go to Step 5 on page 64.	—
Recording mode	[0] [6] [4]	[1] : Standard recording [2] : Enhanced recording	p. 24
Message alert	[0] [≠]	[1] : On   [0] : Off	p. 24
Ringer tone (for base unit)	[0] [*] [1]	[1]–[3] : Tone pattern 1-3 [4]–[7] : Melody pattern 1-4	p. 19
Incoming call tone (for base unit)	[0] [*] [2]	[1] : On   [2] : Twice   [0] : Off	p. 53
Talking Caller ID (for base unit)	[0] [*] [4]	[1] : On   [0] : Off	p. 32

### During programming:

When "Save" is displayed, press the right soft key to **save the new settings**.

**To exit programming**, press [OFF].

- If you press the direct command incorrectly, press [OFF], then re-enter programming mode by pressing [MENU].
- For function details, see the corresponding pages.

## If the Following Appears on Your Display...

The following will be displayed when the unit needs your attention.

Display message	Cause & Remedy
Recharge battery	<ul style="list-style-type: none"> <li>The battery needs to be charged. Recharge the battery (p. 10).</li> </ul>
Charge for 6h	<ul style="list-style-type: none"> <li>The battery has been discharged. The handset will not work. Fully charge the battery (p. 10).</li> </ul>
No link to base. Move closer to base, try again.	<ul style="list-style-type: none"> <li>The handset has lost communication with the base unit. Walk closer to the base unit and try again or re-register the handset (p. 56).</li> <li>Confirm the base unit's AC adaptor is plugged in.</li> <li>Raise the base unit antenna.</li> </ul>
Please lift up and try again.	<ul style="list-style-type: none"> <li>A handset button was pressed while the handset was on the base unit or charger. Lift the handset and press the button again.</li> </ul>
Busy	<ul style="list-style-type: none"> <li>The base unit and/or another handset is in use. Try again later.</li> <li>The handset you tried to send phone book items to is in use. Try again later.</li> <li>The handset you are calling is too far from the base unit.</li> <li>Another handset is in programming mode. Try again later.</li> </ul>
Error!!	<ul style="list-style-type: none"> <li>When you tried to re-register the handset, the handset and base unit could not link for some reason, such as interference from electrical appliances. Move the handset and base unit away from any electrical appliances and try again.</li> <li>Another handset tried to send phone book items to you but the copying stopped (p. 43, 44).</li> </ul>
Phone book full	<ul style="list-style-type: none"> <li>When you tried to store an item in the phone book, the phone book memory was full. Press <b>[OFF]</b> to exit the programming mode. To erase other items from the phone book, see page 42.</li> </ul>
System is busy. Please try again later.	<ul style="list-style-type: none"> <li>The handset has lost communication with the base unit. Walk closer to the base unit and try again.</li> <li>The Answering System is in use, such as answering a call or playing back messages. Try again later.</li> <li>Another handset is in programming mode. Try again later.</li> </ul>



## If the Following Appears on Your Display...

Display message	Cause & Remedy
---Incomplete--- Phone book full	<ul style="list-style-type: none"> <li>When phone book item(s) was(were) sent to another handset, the phone book memory was full and copying stopped. Press <b>[OFF]</b> to exit (p. 43, 44). To erase items from another handset phone book, see page 42. You can copy all of the items again or copy the items which have not been copied one by one (p. 43, 44).</li> </ul>
Example Tom Jones 555-765-4321	<ul style="list-style-type: none"> <li>When you tried to send phone book items, the other handset lost communication with the base unit, or the other handset made an outside call by pressing <b>[↶]</b> or <b>[↷]</b>. The handset displays the phone book item which was not copied to the other handset. Press <b>[OFF]</b>, then try again (p. 43, 44).</li> </ul>
No items stored	<ul style="list-style-type: none"> <li>Your phone book is empty. No items were copied to another handset.</li> </ul>
Save error	<ul style="list-style-type: none"> <li>The entered password was wrong in programming the Dial Lock. Enter the correct password.</li> <li>While programming the Dial Lock, another handset has changed the Dial Lock setting. Check whether your desired setting has been complete or not.</li> </ul>
Dial locked	<ul style="list-style-type: none"> <li>The Dial Lock is turned on. If necessary, cancel the Dial Lock (p. 55).</li> </ul>
Line in use	<ul style="list-style-type: none"> <li>The base unit or another handset is conducting an outside call or a parallel connected telephone is in use.</li> </ul>
Line on hold	<ul style="list-style-type: none"> <li>The base unit or another handset is on hold for an outside call.</li> </ul>

# Troubleshooting

If the handset display shows error messages, see “If the Following Appears on Your Display...” (p. 72–73) for the Cause & Remedy.

## Telephone System

Problem	Cause & Remedy
“No link to base. Move closer to base, try again.” is displayed and an alarm tone sounds.	<ul style="list-style-type: none"> <li>You are too far from the base unit. Walk closer to the base unit.</li> <li>Confirm the base unit’s AC adaptor is plugged in.</li> <li>Raise the base unit antenna.</li> <li>If the above remedies do not solve the problem, the handset may have lost communication with the base unit. Register the handset again (p. 56).</li> </ul>
Static, sound cuts in/out, fades. Interference from other electrical units.	<ul style="list-style-type: none"> <li>Move the handset and base unit away from other electrical appliances (p. 3).</li> <li>Walk closer to the base unit.</li> <li>Raise the base unit antenna.</li> </ul>
The handset and/or base unit does not ring.	<ul style="list-style-type: none"> <li>The ringer volume is turned off. Set to high, medium or, low (p. 17, 18).</li> </ul>
The handset display is blank.	<ul style="list-style-type: none"> <li>If the only handset display is blank, fully charge the battery (p. 10).</li> </ul>
You cannot program any function items.	<ul style="list-style-type: none"> <li>Programming is not possible while the handset and/or base unit is being used.</li> <li>Do not pause for over 60 seconds while programming.</li> <li>Walk closer to the base unit.</li> <li>While another user is listening to messages or the Answering System is handling a call, you cannot program. Try again later.</li> <li>When the Dial Lock is turned on (p. 54), you cannot store the phone number in the phone book.</li> </ul>
While programming or searching, the handset starts to ring and the program/search stops.	<ul style="list-style-type: none"> <li>A call is coming in. To answer the call, press <b>[END]</b>, <b>[MUTE]</b> or <b>[SP-PHONE]</b>. Start again from the beginning after hanging up.</li> </ul>

## Troubleshooting

Problem	Cause & Remedy
You cannot make an intercom/ outside call.	<ul style="list-style-type: none"> <li>• Your handset is in remote operation mode (p. 60). Exit by pressing <b>[OFF]</b>.</li> <li>• The handset you called is too far from the base unit.</li> <li>• If the handset or base unit is in use, you may not be able to make a call. Try again later.</li> <li>• You cannot make an outside call when the Dial Lock is turned on. To cancel the mode, see page 55.</li> </ul>
You cannot redial.	<ul style="list-style-type: none"> <li>• If the last number dialed was more than 48 digits long, the number will not be redialed correctly.</li> <li>• You cannot redial when the Dial Lock is turned on. To cancel the mode, see page 55.</li> </ul>
The handset does not display the caller's phone number.	<ul style="list-style-type: none"> <li>• You need to subscribe to Caller ID.</li> <li>• Other telephone equipment may be interfering with your phone. Disconnect it and try again.</li> <li>• Other electrical appliances connected to the same outlet may be interfering with Caller ID.</li> <li>• Telephone line noise may be affecting Caller ID.</li> <li>• The caller requested not to send his/her Caller ID information (p. 30).</li> <li>• If a call is being transferred to you, the Caller ID information will not be displayed.</li> <li>• If a (separate) Caller ID box is connected between the unit and the telephone wall jack, disconnect the Caller ID box or plug the unit directly into the wall jack.</li> </ul>
The handset and/or base unit does not announce the displayed caller's name.	<ul style="list-style-type: none"> <li>• The handset and/or base unit ringer volumes are turned off. Set to high, medium, or low (p. 17, 18).</li> <li>• The Talking Caller ID feature is turned off. Turn it on (p. 32).</li> </ul>
The handset and/or base unit does not announce the displayed caller's name properly.	<ul style="list-style-type: none"> <li>• Name pronunciation may vary.</li> <li>• The handset and/or base unit will announce each letter of abbreviations, such as "Co." and "Inc."</li> <li>• Caller ID supports names of up to 15 letters. If the caller's name has more than 15 letters, the name will not be announced correctly.</li> </ul>

## Troubleshooting

Problem	Cause & Remedy
The handset display exits the Caller List or phone book.	<ul style="list-style-type: none"> <li>Do not pause for over 60 seconds while searching.</li> </ul>
The Ringer/Message Alert indicator flashes slowly when the handset is not ringing and in use.	<ul style="list-style-type: none"> <li>The Message Alert is turned on and new messages have been recorded. Turn the Message Alert off (p. 24) or listen to the new messages (p. 59, 60, 64).</li> </ul>
You cannot have a conversation using the headset.	<ul style="list-style-type: none"> <li>Make sure the optional headset is connected properly (p. 67).</li> <li>If "SP-phone" is displayed on the handset, press [] to switch to the headset.</li> </ul>

## Answering System

Problem	Cause & Remedy
The Answering System is on, but incoming messages are not recorded.	<ul style="list-style-type: none"> <li>The recording time is set to "Greeting only". Select "1 minute", "2 minutes" or "3 minutes" (p. 22).</li> <li>Memory is full. Erase unnecessary messages (p. 62).</li> </ul>
" <b>FULL</b> " flashes and the ANSWER ON indicator flashes rapidly. No new messages are recorded.	<ul style="list-style-type: none"> <li>Memory is full. Erase unnecessary messages (p. 62).</li> </ul>
You cannot operate the Answering System from the base unit or the handset.	<ul style="list-style-type: none"> <li>If another user is in use, you may not be able to operate the Answering System. Try again later.</li> <li>If another user is listening to messages or the Answering System is handling a call, you cannot operate the Answering System. Try again later.</li> </ul>
You cannot operate the Answering System from a touch tone phone.	<ul style="list-style-type: none"> <li>Make sure you entered the correct remote code (p. 64).</li> <li>The Answering System may not respond if the tones are too short to activate the unit. Press each button firmly.</li> <li>The Answering System is off. Turn it on (p. 66).</li> </ul>
You cannot erase messages.	<ul style="list-style-type: none"> <li>While another user is operating the Answering System or a caller is leaving a message, you cannot erase messages.</li> </ul>

## Troubleshooting

Problem	Cause & Remedy
When you play back messages or turn on the Answering System, the handset and/or base unit announces the wrong day and time.	<ul style="list-style-type: none"> <li>The date and time may be set incorrectly. Set the date and time again (p. 14).</li> </ul>

### General

Problem	Cause & Remedy
The handset and/or base unit does not work.	<ul style="list-style-type: none"> <li>Check the settings (p. 9–11).</li> <li>Check whether the dialing mode setting is correct (p. 15).</li> <li>Fully charge the battery (p. 10).</li> <li>Clean the charge contacts and charge again (p. 11).</li> <li>Check battery installation (p. 10).</li> <li>Unplug the base unit's AC adaptor to reset it. Plug in, and try again.</li> <li>Re-install the battery (p. 10) and fully charge it.</li> </ul>
Time setting is erased, and "⊖" flashes on the base unit display or "⊖ Press MENU." flashes on the handset display.	<ul style="list-style-type: none"> <li>If a power failure occurs, time setting may be erased. Set the date and time again (p. 14).</li> </ul>
"Recharge battery" is displayed, "▢" flashes, or the handset beeps intermittently.	<ul style="list-style-type: none"> <li>Fully charge the battery (p. 10).</li> </ul>
"Charge for 6h" and "▢" are displayed and the handset does not work.	<ul style="list-style-type: none"> <li>The battery has been discharged. Fully charge the battery (p. 10).</li> <li>Check battery installation (p. 10).</li> </ul>
You charged the battery fully, but "Recharge battery" is still displayed and/or "▢" continues to flash, or "Charge for 6h" and "▢" are displayed.	<ul style="list-style-type: none"> <li>Clean the charge contacts and charge again (p. 11).</li> <li>The battery may need to be replaced. If you install a new battery, fully charge it (p. 10).</li> </ul>
The CHARGE indicator does not go out after the battery has been charged.	<ul style="list-style-type: none"> <li>This is normal.</li> </ul>

# Safety Instructions

---

Take special care to follow the safety suggestions listed below.

## Safety

- 1) The unit should be connected to a power supply only of the type described in the operating instructions or as marked on the unit.
- 2) When left unused for a long period of time, the base unit should be unplugged from the household AC outlet.

## Installations

### Environment

- 1) Do not use this unit near water—for example, near a bathtub, washbowl, sink, etc. Damp basements should also be avoided.
- 2) The unit should be kept away from heat sources such as radiators, kitchen range, etc. It also should not be placed in rooms where the temperature is less than 5°C or greater than 40°C.
- 3) The AC adaptor is used as the main disconnect device, ensure that the AC outlet is located/installed near the unit and is easily accessible.

### Placement

- 1) Do not place heavy objects on top of this unit.
- 2) Care should be taken so that objects do not fall onto, and liquids are not spilled into, the unit. Do not subject this unit to excessive smoke, dust, mechanical vibration or shock.
- 3) Place the unit on a flat surface.

### For best performance

- 1) If noise prevents the conversation from being understood at the handset, approach the base unit to lessen the noise.
- 2) The handset should be used at the HIGH volume setting when the reception tone is difficult to hear.
- 3) The handset should be fully recharged on the base unit when “Recharge battery” is displayed and/or “” flashes.
- 4) The handset antenna should not be touched during use because of its high sensitivity.
- 5) The maximum calling distance may be shortened when the unit is used in the following places: Near obstacles such as hills, tunnels, undergrounds, near metal objects such as wire fences, etc.

### Medical

Consult the manufacturer of any personal medical devices, such as pacemakers or hearing aids, to determine if they are adequately shielded from external RF (radio frequency) energy. (The unit operates in the frequency range of 2400 MHz to 2481 MHz, and the power output level can range from 0.04 watts to 0.1 watts.) Do not use the unit in health care facilities if any regulations posted in the area instruct you not to do so. Hospitals or health care facilities may be using equipment that could be sensitive to external RF (radio frequency) energy.

Operating near 2.4 GHz electrical appliances may cause interference. Move away from the electrical appliances.

## Safety Instructions

---

### **WARNING:**

TO PREVENT FIRE OR SHOCK HAZARD, DO NOT EXPOSE THIS PRODUCT TO RAIN OR ANY TYPE OF MOISTURE.

If there is any trouble, disconnect the unit from the telephone line and connect a known working phone. If the known working phone operates properly, do not reconnect the unit to the telephone line until the trouble has been repaired. If the known working phone does not operate properly, consult your telephone company.

## Specifications

---

### ■ Base Unit

<b>Power Supply:</b>	AC Adaptor (220–240 V AC, 50/60 Hz)
<b>Power Consumption:</b>	Standby: Approx. 2.3 W Maximum: Approx. 5.2 W
<b>Frequency:</b>	2.4 GHz – 2.48 GHz
<b>Dimensions (H x W x D):</b>	Approx. 85 mm x 175 mm x 200 mm
<b>Mass (Weight):</b>	Approx. 470 g

### ■ Charger

<b>Power Supply:</b>	AC Adaptor (220–240 V AC, 50/60 Hz)
<b>Power Consumption:</b>	Standby: Approx. 1.1 W Maximum: Approx. 3.9 W
<b>Dimensions (H x W x D):</b>	Approx. 69 mm x 74 mm x 99 mm
<b>Mass (Weight):</b>	Approx. 110 g

### ■ Handset

<b>Power Supply:</b>	Ni-MH battery (3.6 V, 830 mAh)
<b>Frequency:</b>	2.4 GHz – 2.48 GHz
<b>Dimensions (H x W x D):</b>	Approx. 208 mm x 52 mm x 39 mm
<b>Mass (Weight):</b>	Approx. 190 g
<b>Security Codes:</b>	1,000,000

■ **Dialing Mode:** Tone (DTMF)/Pulse

■ **Operating Environment:** 5 °C – 40 °C

Specifications are subject to change without notice.

**Panasonic Communications Co., Ltd.**

1-62, 4-chome, Minoshima, Hakata-ku, Fukuoka 812-8531, Japan

© 2004 Panasonic Communications Co., Ltd. All Rights Reserved.

**PQQX14264ZA F0504-0** Ⓣ

