



Panasonic®

Operating Instructions

Premium Design Phone

Model No. **KX-PRS120**



*Before initial use, see “Getting Started”
on page 9.*

Thank you for purchasing a Panasonic product.

Please read these operating instructions before using the unit and save them for future reference.

Consulte “Guía Rápida Española”, página 49.

For assistance, visit our Web site: <http://www.panasonic.com/help> for customers in the U.S.A. or Puerto Rico.

Please register your product: <http://www.panasonic.com/prodreg>

Table of Contents

Introduction

Accessory information	3
-----------------------------	---

Important Information

For your safety	5
Important safety instructions	6
For best performance	6
Other information	7
Specifications	7

Getting Started

Setting up	9
Intelligent eco mode	10
Controls	11
Display icons	11
Language setting	12
Date and time	12
Other settings	12

Making/Answering Calls

Making calls	14
Answering calls	14
Useful features during a call	14
Intercom	16

Phonebook

Phonebook	17
Speed dial	19

Programming

Menu list	21
Alarm	27
Silent mode	27
Call block	28
Baby monitor	29
Other programming	31
Registering a unit	32

Caller ID Service

Using Caller ID service	33
Caller list	33

Answering System

Answering system	35
Turning the answering system on/off	35
Greeting message	35
Listening to messages	36
Advanced new message alerting features	37

Remote operation	38
Answering system settings	40

Useful Information

Voice mail service	41
Error messages	42
Troubleshooting	43
FCC and other information	47

Guía Rápida Española

Guía Rápida Española	49
----------------------------	----

Appendix

Customer services	53
Warranty (For United States and Puerto Rico)	54

Index

Index.....	56
------------	----

Accessory information

Supplied accessories

No.	Accessory item/Order number	Quantity
①	AC adaptor/PNLV226-KZ	1
②	Telephone line cord/PQJA10075Z	1
③	Rechargeable batteries/HHR-4DPA	2
④	Handset cover*1/PNYNPRSA10WR	1

*1 The handset cover comes attached to the handset.



Additional/replacement accessories

Please contact your nearest Panasonic dealer for sales information (page 53).

Accessory item	Order number
Rechargeable batteries	HHR-4DPA*1 ● To order, please visit http://www.panasonic.com/batterystore
	Battery type: – Nickel metal hydride (Ni-MH) – 2 x AAA (R03) size for each handset
T-adaptor	KX-J66
Range extender	KX-TGA405*2
Key detector	KX-TGA20*3

*1 Replacement batteries may have a different capacity from that of the supplied batteries.

*2 By installing this unit, you can extend the range of your phone system to include areas where reception was previously not available. This product can be purchased online. Please visit our Web site: <http://www.panasonic.com/RangeExtender>

*3 By registering the key detector (4 max.) to a Panasonic Digital Cordless Phone and attaching it to an easy-to-lose item in advance, you can locate and find the mislaid item to which the key detector is attached. Please visit our Web site:
<http://panasonic.net/pcc/products/telephone/p/tga20/>

Other information

- Design and specifications are subject to change without notice.
- The illustrations in these instructions may vary slightly from the actual product.

Expanding your phone system

Handset (optional): KX-PRSA10

You can expand your phone system by registering optional handsets (6 max.) to a single base unit.

- Optional handsets may be a different color from that of the supplied handsets.



For your safety

To prevent severe injury and loss of life/property, read this section carefully before using the product to ensure proper and safe operation of your product.

WARNING

Power connection

- Use only the power source marked on the product.
- Do not overload power outlets and extension cords. This can result in the risk of fire or electric shock.
- Completely insert the AC adaptor/power plug into the power outlet. Failure to do so may cause electric shock and/or excessive heat resulting in a fire.
- Regularly remove any dust, etc. from the AC adaptor/power plug by pulling it from the power outlet, then wiping with a dry cloth. Accumulated dust may cause an insulation defect from moisture, etc. resulting in a fire.
- Unplug the product from power outlets if it emits smoke, an abnormal smell, or makes an unusual noise. These conditions can cause fire or electric shock. Confirm that smoke has stopped emitting and contact us at <http://www.panasonic.com/contactinfo>
- Unplug from power outlets and never touch the inside of the product if its casing has been broken open.
- Never touch the plug with wet hands. Danger of electric shock exists.

Installation

- To prevent the risk of fire or electrical shock, do not expose the product to rain or any type of moisture.
- Do not place or use this product near automatically controlled devices such as automatic doors and fire alarms. Radio waves emitted from this product may cause such devices to malfunction resulting in an accident.

- Do not allow the AC adaptor or telephone line cord to be excessively pulled, bent or placed under heavy objects.

Operating safeguards

- Unplug the product from power outlets before cleaning. Do not use liquid or aerosol cleaners.
- Do not disassemble the product.
- Do not spill liquids (detergents, cleansers, etc.) onto the telephone line cord plug, or allow it to become wet at all. This may cause a fire. If the telephone line cord plug becomes wet, immediately pull it from the telephone wall jack, and do not use.

Medical

- Consult the manufacturer of any personal medical devices, such as pacemakers or hearing aids, to determine if they are adequately shielded from external RF (radio frequency) energy. (The product operates in the frequency range of 1.92 GHz to 1.93 GHz, and the RF transmission power is 115 mW (max.).)
- Do not use the product in health care facilities if any regulations posted in the area instruct you not to do so. Hospitals or health care facilities may be using equipment that could be sensitive to external RF energy.

CAUTION

Installation and location

- Never install telephone wiring during an electrical storm.
- Never install telephone line jacks in wet locations unless the jack is specifically designed for wet locations.
- Never touch uninsulated telephone wires or terminals unless the telephone line has been disconnected at the network interface.
- Use caution when installing or modifying telephone lines.
- The AC adaptor is used as the main disconnect device. Ensure that the AC outlet is installed near the product and is easily accessible.

Important Information

- This product is unable to make calls when:
 - the handset batteries need recharging or have failed.
 - there is a power failure.

Battery

- We recommend using the batteries noted on page 3. **USE ONLY rechargeable Ni-MH batteries AAA (R03) size.**
- Do not mix old and new batteries.
- Do not open or mutilate the batteries. Released electrolyte from the batteries is corrosive and may cause burns or injury to the eyes or skin. The electrolyte is toxic and may be harmful if swallowed.
- Exercise care when handling the batteries. Do not allow conductive materials such as rings, bracelets, or keys to touch the batteries, otherwise a short circuit may cause the batteries and/or the conductive material to overheat and cause burns.
- Charge the batteries provided with or identified for use with this product only, in accordance with the instructions and limitations specified in this manual.
- Only use a compatible base unit (or charger) to charge the batteries. Do not tamper with the base unit (or charger). Failure to follow these instructions may cause the batteries to swell or explode.

Attention:



A nickel metal hydride battery that is recyclable powers the product you have purchased.

Please call 1-800-8-BATTERY (1-800-822-8837) for information on how to recycle this battery.

Important safety instructions

When using your product, basic safety precautions should always be followed to reduce the risk of fire, electric shock, and injury to persons, including the following:

1. Do not use this product near water for example, near a bathtub, washbowl, kitchen sink, or laundry tub, in a wet basement or near a swimming pool.
2. Avoid using a telephone (other than a cordless type) during an electrical storm. There may be a remote risk of electric shock from lightning.
3. Do not use the telephone to report a gas leak in the vicinity of the leak.
4. Use only the power cord and batteries indicated in this manual. Do not dispose of batteries in a fire. They may explode. Check with local codes for possible special disposal instructions.

SAVE THESE INSTRUCTIONS

For best performance

Base unit location/avoiding noise

The base unit and other compatible Panasonic units use radio waves to communicate with each other.

- For maximum coverage and noise-free communications, place your base unit:
 - at a convenient, high, and central location with no obstructions between the handset and base unit in an indoor environment.
 - away from electronic appliances such as TVs, radios, personal computers, wireless devices, or other phones.
 - facing away from radio frequency transmitters, such as external antennas of mobile phone cell stations. (Avoid putting the base unit on a bay window or near a window.)
- Coverage and voice quality depends on the local environmental conditions.

- If the reception for a base unit location is not satisfactory, move the base unit to another location for better reception.

Environment

- Keep the product away from electrical noise generating devices, such as fluorescent lamps and motors.
- The product should be kept free from excessive smoke, dust, high temperature, and vibration.
- The product should not be exposed to direct sunlight.
- Do not place heavy objects on top of the product.
- When you leave the product unused for a long period of time, unplug the product from the power outlet.
- The product should be kept away from heat sources such as heaters, kitchen stoves, etc. It should not be placed in rooms where the temperature is less than 0 °C (32 °F) or greater than 40 °C (104 °F). Damp basements should also be avoided.
- The maximum calling distance may be shortened when the product is used in the following places: Near obstacles such as hills, tunnels, underground, near metal objects such as wire fences, etc.
- Operating the product near electrical appliances may cause interference. Move away from the electrical appliances.

Routine care

- **Wipe the outer surface of the product with a soft moist cloth.**
- Do not use benzene, thinner, or any abrasive powder.

Other information

CAUTION: Risk of explosion if battery is replaced by an incorrect type. Dispose of used batteries according to the instructions.

Notice for product disposal, transfer, or return

- This product can store your private/confidential information. To protect your privacy/confidentiality, we recommend that you erase information such as phonebook or caller list entries from the memory before you dispose of, transfer, or return the product.

Notice

- This product is designed for use in the United States of America. Sale or use of this product in other countries may violate local laws.
- Cet appareil est conçu pour être utilisé aux États-Unis d'Amérique. La vente ou l'emploi de cet appareil dans certains autres pays peut constituer une infraction à la législation locale.
- Este producto está diseñado para usarse en los Estados Unidos de América. La venta o el empleo de este producto en ciertos países puede constituir violación de la legislación local.
- 本產品專為美國使用而設。若在其他國家銷售或使用，可能會違反當地法例。
- この製品は、日本国外での使用を目的として設計されており、日本国内での使用は法律違反となります。従って、当社では日本国内においては原則として修理などのサービスは致しかねます。

Specifications

- **Standard:**
DECT 6.0 (Digital Enhanced Cordless Telecommunications 6.0)
- **Frequency range:**
1.92 GHz to 1.93 GHz
- **RF transmission power:**
115 mW (max.)
- **Power source:**
120 V AC, 60 Hz
- **Power consumption:**
Base unit:
Standby: Approx. 0.6 W
Maximum: Approx. 2.8 W

Important Information

- **Operating conditions:**
0 °C – 40 °C (32 °F – 104 °F), 20 % – 80 %
relative air humidity (dry)

Setting up

Connections

■ Base unit

- ① Connect the AC adaptor plug to the unit until you hear a click.
- ② Fasten the cord by hooking it.
- ③ Connect the AC adaptor to the power outlet.
- ④ Connect the telephone line cord to the unit until you hear a click.
- ⑤ Fasten the cord by hooking it.
- ⑥ Connect the telephone line cord to the single-line telephone jack (RJ11C) until you hear a click.
- ⑦ A DSL/ADSL filter (not supplied) is required if you have a DSL/ADSL service.

Note:

- Use only the supplied Panasonic AC adaptor PNLV226.

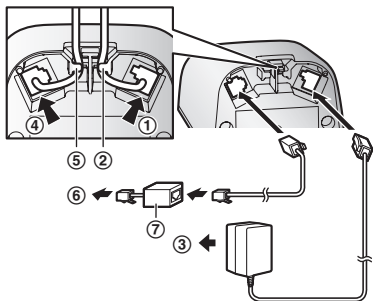

- Confirm correct polarities (⊕, ⊖).

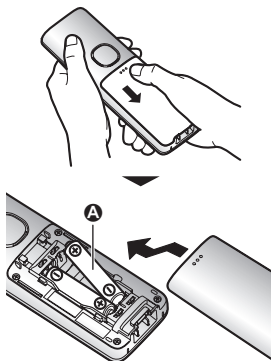

- Follow the directions on the display to set up the unit.

Battery installation

- USE ONLY rechargeable Ni-MH batteries AAA (R03) size (A).
- Do NOT use Alkaline/Manganese/Ni-Cd batteries.

Battery charging

Charge for about 7 hours.

- Confirm "Charging" is displayed (A).
- When the batteries are fully charged, "Fully charged" is displayed.

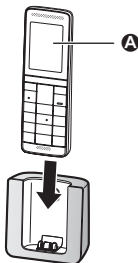

Note when setting up

Note for connections

- The AC adaptor must remain connected at all times. (It is normal for the adaptor to feel warm during use.)
- The AC adaptor should be connected to a vertically oriented or floor-mounted AC outlet. Do not connect the AC adaptor to a ceiling-mounted AC outlet, as the weight of the adaptor may cause it to become disconnected.

During a power failure

The unit will not work during a power failure. We recommend connecting a corded-type telephone (without AC adaptor) to the same telephone line or to the same telephone line jack using a Panasonic T-adaptor (page 3).

Note for battery installation

- Use the supplied rechargeable batteries. For replacement, we recommend using the Panasonic rechargeable batteries noted on page 3, 6.

Note for battery charging

- It is normal for the handset to feel warm during charging.

- Clean the charge contacts of the handset, base unit, and charger with a soft and dry cloth once a month. Before cleaning the unit, disconnect from power outlets and any telephone line cords. Clean more often if the unit is exposed to grease, dust, or high humidity.

Battery level

Icon	Battery level
	High
	Medium
	Low
	Needs charging.
	Empty

Panasonic Ni-MH battery performance (supplied batteries)

Operation	Operating time
In continuous use	10 hours max.*1
Not in use (standby)	6 days max.*1

*1 If eco mode is on.

Note:

- Actual battery performance depends on usage and ambient environment.

Intelligent eco mode

This feature automatically reduces handset power consumption by suppressing handset transmission power when the handset is close to the base unit.

- When this feature is activated, **ECO** is displayed.
- Eco mode is turned off when the clarity booster is activated (page 15).

Controls

Handset

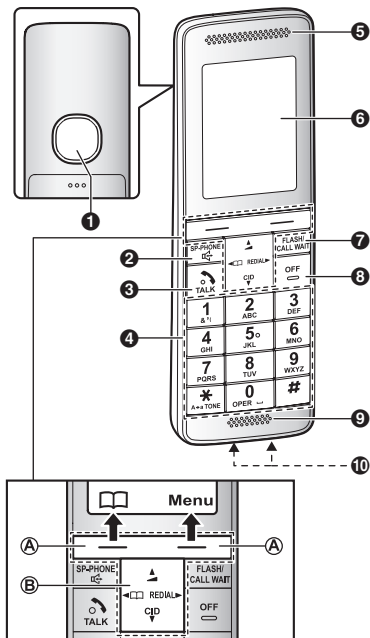

- 1 Speaker
- 2 **[SP-PHONE]** (SP-PHONE: Speakerphone)
- 3 **[TALK]**
- 4 Dial keypad (**[TONE]**)
- 5 Receiver
- 6 Display
- 7 **[FLASH][CALL WAIT]**
- 8 **[OFF]**
- 9 Microphone
- 10 Charge contacts

Control type

(A) Soft keys

By pressing a soft key, you can select the feature shown directly above it on the display.

(B) Navigator key

- **[▲], [▼], [◀], [▶]**: Scroll through various lists and items.
- **[VOLUME]** (Volume: **[▲]** or **[▼]**): Adjust the receiver or speaker volume while talking.
- **[CID]** (Caller ID): View the caller list.
- **[PHONEBOOK]**: View the phonebook entry.
- **[RECALL]**: View the redial list.

Base unit

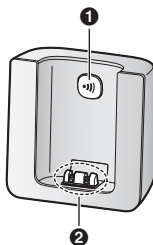









- 1 **[Locator]**
 - You can locate a misplaced handset by pressing **[Locator]**.
- 2 **Charge contacts**

Display icons



Handset display items

Item	Meaning
	Within base unit range
	Out of base unit range
	The line is in use. <ul style="list-style-type: none"> • When flashing slowly: The call is put on hold. • When flashing rapidly: An incoming call is now being received.
ECO	Eco mode is on. (page 10)
NR	Noise reduction is set. (page 15)
	Speakerphone is on. (page 14)

Getting Started

Item	Meaning
	Answering system is on. (page 35)
	Ringer volume is off. (page 23)
	Silent mode is on. (page 27)
PRIVACY	Call sharing mode is off. (page 25)
	Alarm is on. (page 27)
EQ	Equalizer is set. (page 15)
	The key backlight is off. (page 24)
1	Handset number
	Battery level
	Blocked call (page 28)
	Baby monitor is activated. The name/number displayed next to the icon indicates the monitoring unit. (page 29)
Booster on	Clarity booster is on. (page 15)
Line in use	Someone is using the line.
In use	Answering system is being used by another handset.

Handset soft key icons

Icon	Action
	Temporarily turns off the ringer for incoming calls. (page 14)
	Opens the phonebook.

Language setting

Display language

You can select either “English” or “Español” as the display language. The default setting is “English”.

- [Menu]** (right soft key) **#1110**

- [↕]**: Select the desired setting. → **[Save]**
- [OFF]**

Voice guidance language

You can select either “English” or “Español” as the voice guidance language of the answering system. The default setting is “English”.

- [Menu]** (right soft key) **#1112**
- [↕]**: Select the desired setting.
- [Save]** → **[OFF]**

Date and time

- [Menu]** (right soft key) **#101**
- Enter the current month, date, and year by selecting 2 digits for each.
Example: July 15, 2013
07 15 13
- [OK]**
- Enter the current hour and minute (12-hour clock format) by selecting 2 digits for each.
Example: 9:30
09 30
- [X]**: Select “AM” or “PM”.
- [Save]** → **[OFF]**

Note:

- When English is selected as the display language, 12-hour clock format is used. When Spanish is selected, 24-hour clock format is used.

Other settings

Screen saver mode

The backlight goes dark when on a call or turns off completely after 1 minute of inactivity if the handset is not on the base unit or charger.
Activate the handset display again by:

- pressing [] when on a call.
- pressing [**OFF**] at all other times.

Dialing mode

If you cannot make calls, change this setting according to your telephone line service. The default setting is “**Tone**”.

“**Tone**”: For tone dial service.

“**Pulse**”: For rotary/pulse dial service.

- 1** [**Menu**] (right soft key) **#** **1** **2** **0**
- 2** [**↓**]: Select the desired setting.
- 3** [**Save**] → [**OFF**]

Making calls

- 1 Lift the handset and dial the phone number.
 - To correct a digit, press **[Clear]**.
- 2 Press **[↶]**.
- 3 When you finish talking, press **[OFF]** or place the handset on the base unit or charger.

Using the speakerphone

- 1 Dial the phone number and press **[📞]**.
- 2 When you finish talking, press **[OFF]**.

Note:

- To switch back to the receiver, press **[📞]/[↶]**.

Adjusting the receiver or speaker volume

Press **[▲]** or **[▼]** repeatedly while talking.

Making a call using the redial list

The last 5 phone numbers dialed are stored in the redial list (each 48 digits max.).

- 1 **[▶]** REDIAL
- 2 **[↕]**: Select the desired phone number.
- 3 **[↶]**

Erasing a number in the redial list

- 1 **[▶]** REDIAL
- 2 **[↕]**: Select the desired phone number.
→ **[Erase]**
- 3 **[↕]**: "Yes" → **[Select]** → **[OFF]**

Pause (for PBX/long distance service users)

A pause is sometimes required when making calls using a PBX or long distance service. When storing a calling card access number and/or PIN in the phonebook, a pause is also needed (page 19).

Example: If you need to dial the line access number "9" when making outside calls with a PBX:

- 1 **[9]** → **[▲]** (Pause)
- 2 Dial the phone number. → **[↶]**

Note:

- A 3.5 second pause is inserted each time **[▲]** (Pause) is pressed.

Answering calls

- 1 Lift the handset and press **[↶]** or **[📞]** when the unit rings.
- 2 When you finish talking, press **[OFF]** or place the handset on the base unit or charger.

Any key answer: You can answer the call by pressing any dial key.

Auto talk: You can answer calls simply by lifting the handset (page 24).

Temporary ringer off: You can turn the ringer off temporarily by pressing **[🔕]**.

Adjusting the handset ringer volume

Press **[▲]** or **[▼]** repeatedly to select the desired volume while ringing.

Useful features during a call

Hold

- 1 Press **[Menu]** during an outside call.
- 2 **[↕]**: "Hold" → **[Select]**
- 3 To release hold, press **[↶]**.

Note:

- After holding for 10 minutes, the call is disconnected.

Mute

- 1 Press **[Mute]** during a call.

- 2 To return to the call, press **[Mute]**.

Flash

[FLASH] allows you to use the special features of your host PBX such as transferring an extension call, or accessing optional telephone services.

Note:

- To change the flash time, see page 25.

For call waiting or Call Waiting Caller ID service users

To use call waiting or Call Waiting Caller ID, you must first subscribe with your service provider/telephone company.

This feature allows you to receive calls while you are already talking on the phone. If you receive a call while on the phone, you will hear a call waiting tone.

If you subscribe to both Caller ID and Call Waiting with Caller ID services, the 2nd caller's information is displayed after you hear the call waiting tone on the handset.

- 1 Press **[CALL WAIT]** to answer the 2nd call.
- 2 To switch between calls, press **[CALL WAIT]**.

Note:

- Please contact your service provider/telephone company for details and availability of this service in your area.

Temporary tone dialing (for rotary/pulse service users)

Press **[*]** (TONE) before entering access numbers which require tone dialing.

Handset clarity booster

This feature can improve sound clarity when the handset is used in an area where there may be interference. During an outside call, this feature is turned on automatically when necessary.

- When this feature is turned on, "Booster on" is displayed.

Handset noise reduction

This feature allows you to hear the voice of the person you are talking to clearly, by reducing the surrounding noise coming from the other party's telephone.

- 1 Press **[Menu]** while talking.
- 2 **[↕]**: "Noise reduction on" or "Noise reduction off" → **[Select]**

Note:

- Depending on the environment where this handset is being used, this feature may not be effective.
- This feature is not available using the speakerphone.

Handset equalizer

This feature clarifies the voice of the person you are talking to, producing a more natural-sounding voice that is easier to hear and understand.

- 1 Press **[Menu]** while talking.
- 2 **[↕]**: "Equalizer" → **[Select]**
- 3 **[↕]**: Select the desired setting.
- 4 Press **[OK]** to exit.

Note:

- Depending on the condition and quality of your telephone line, this feature may emphasize existing line noise. If it becomes difficult to hear, turn this feature off.
- This feature is not available while using the speakerphone.

Call share

You can join an existing outside call. To join the conversation, press **[📞]** when the other handset is on an outside call.

Note:

- A maximum of 3 parties (including 1 outside party) can join a conversation using 2 extensions. **(3-way conference)**

Making/Answering Calls

- To prevent other users from joining your conversations with outside callers, turn the call sharing mode off (page 25).

Transferring calls, conference calls

Outside calls can be transferred between 2 handsets in the same radio cell.
2 handsets in the same radio cell can have a conference call with an outside party.

- 1 During an outside call, press **[Menu]**.
- 2 **[↕]**: "Intercom" → **[Select]**
- 3 **[↕]**: Select the desired unit. → **[Select]**
- 4 Wait for the paged party to answer.
 - If the paged party does not answer, press **[Back]** to return to the outside call.
- 5 **To complete the transfer:**
Press **[OFF]**.
To establish a conference call:
[Menu] → **[↕]**: "Conference" → **[Select]**
 - To leave the conference, press **[OFF]**.
The other 2 parties can continue the conversation.
 - To put the outside call on hold:
[Menu] → **[↕]**: "Hold" → **[Select]**
To resume the conference: **[Menu]** → **[↕]**: "Conference" → **[Select]**
 - To cancel the conference: **[Menu]** → **[↕]**: "Stop conference" → **[Select]**
You can continue the conversation with the outside caller.

Intercom

Intercom calls can be made between handsets.

Note:

- When paging the handset, the paged handset beeps for 1 minute.
- If you receive an outside call while talking on the intercom, you hear 2 tones. To answer the call, press **[OFF]**, then press **[↶]**.

Making an intercom call

- 1 **[Menu]** (right soft key) → **[Intercom]**
- 2 **[↕]**: Select the desired unit. → **[Select]**
- 3 When you finish talking, press **[OFF]**.

Answering an intercom call

- 1 Press **[↶]** to answer the page.
- 2 When you finish talking, press **[OFF]**.

Turning auto intercom on/off

This feature allows the handset to answer intercom calls automatically when it is called. You do not need to press **[↶]**. When this feature is set to "On", the monitoring handset for the baby monitor feature (page 30) will also answer baby monitor calls automatically. The default setting is "OFF".

- 1 **[Menu]** (right soft key) **[#][2][7][3]**
- 2 **[↕]**: Select the desired setting. → **[Save]** → **[OFF]**

Phonebook

You can add 300 names (16 characters max.) and phone numbers (24 digits max.) to the phonebook, and assign each phonebook entry to the desired group.

The total number of entries that can be stored varies depending on how many phone numbers you have stored for each entry.

Total number of entries is shown below*1:

1 name + 1 phone number: 300 entries

1 name + 2 phone numbers: 150 entries

1 name + 3 phone numbers: 100 entries

*1 Up to 3 phone numbers for each entry can be stored.

Important:

- All entries can be shared by any registered handset.

Adding phonebook entries

- [**☐☐**] or [**◀**] **☐☐** → [**Menu**]
- [**↕**]: "Add new entry" → [**Select**]
- [**↕**]: "(Name)" → [**Select**]
- Enter the party's name. → [**OK**]
- [**↕**]: "(Phone no. 1)" → [**Select**]
 - You can store up to 3 phone numbers for each entry.
- Enter the party's phone number. → [**OK**]
- [**↕**]: "Group 1" → [**Select**]
- [**↕**]: Select the desired group. → [**Select**]
- [**Save**] → [**OFF**]

Character table for entering names

While entering characters, you can switch between uppercase and lowercase by pressing **⊞** (A→a).

Key	Character
[1]	& ' () * , - . / 1

Key	Character
[2]	A B C 2 a b c 2
[3]	D E F 3 d e f 3
[4]	G H I 4 g h i 4
[5]	J K L 5 j k l 5
[6]	M N O 6 m n o 6
[7]	P Q R S 7 p q r s 7
[8]	T U V 8 t u v 8
[9]	W X Y Z 9 w x y z 9
[0]	␣ 0
[#]	#

- To enter another character that is located on the same dial key, first press [**▶**] to move the cursor to the next space.
- If you do not press any dial key within 5 seconds after entering a character, the character is fixed and the cursor moves to the next space.
- ␣ in the above table represents a single space.

Erasing the character or number

Press [**◀**] or [**▶**]. → [**Clear**]

- Press and hold [**Clear**] to erase all characters or numbers.

Storing a redial list number to the phonebook

- [**▶**] REDIAL
- [**↕**]: Select the desired phone number. → [**Detail**] → [**Save**]
- To store the name, continue from step 3, "Editing entries", page 18.

Storing caller information to the phonebook

- 1 **[v]** CID
- 2 **[↕]**: Select the desired entry. → **[Detail]**
 - To edit the number: **[Menu]** → **[↕]**: "Edit" → **[Select]**
Press **[Edit]** repeatedly until the phone number is shown in the desired format. And then, press **[Save]**. Go to step 5.
- 3 **[Menu]**
- 4 **[↕]**: "Save CID" → **[Select]**
- 5 **[↕]**: "Phonebook" → **[Select]**
- 6 Continue from step 3, "Editing entries", page 18.

Groups

Groups can help you find entries in the phonebook quickly and easily. You can change the names of groups ("Friends", "Family", etc.). By assigning different ringer tones for different groups of callers, you can identify who is calling (ringer ID), if you have subscribed to Caller ID service.

Changing group names/setting ringer ID

- 1 **[□□]** or **[◀] □□** → **[Menu]**
- 2 **[↕]**: "Group" → **[Select]**
- 3 **[↕]**: Select the desired group. → **[Select]**
- 4 **To change group names**
[↕]: "Group name" → **[Select]** → Edit the name (10 characters max.; page 17). → **[Save]**
To set group ringer tone
[↕]: Select the current setting of the group ringer tone. → **[Select]** → **[↕]**: Select the desired ringer tone. → **[Save]**
- 5 **[OFF]**

Finding and calling from a phonebook entry

- 1 **[□□]** or **[◀] □□**
- 2 **To scroll through all entries**
[↕]: Select the desired entry. → **[↶]**
To search by first character
 - ① Press the dial key (**[0]** to **[9]**, or **[#]**) which contains the character you are searching for (page 17).
 - ② **[↕]**: Scroll through the phonebook if necessary. → **[↶]****To search by query**
 - ① **[*]** → To search for the name, enter the first characters (up to 4) in uppercase (page 17). → **[OK]**
 - ② **[↕]**: Scroll through the phonebook if necessary. → **[↶]****To search by group**
 - ① **[Group]**
 - ② **[↕]**: Select the desired group. → **[Select]**
 - ③ **[↕]**: Scroll through the phonebook if necessary. → **[↶]**
- 3 **[↕]**: Select the desired phone number. → **[↶]**

Editing entries

- 1 Find the desired entry (page 18). → **[Menu]**
- 2 **[↕]**: "Edit" → **[Select]**
- 3 **[↕]**: Select the desired item you want to change. → **[Select]**
- 4 **To change the name and phone number:**
Edit the name or phone number. → **[OK]**
To change the group:
[↕]: Select the desired group. → **[Select]**
- 5 **[Save]** → **[OFF]**

Erasing entries

Erasing an entry

- 1 Find the desired entry (page 18). → **[Menu]**

- 2 [↵]: "Erase" → [Select]
- 3 [↵]: "Yes" → [Select] → [OFF]

Erasing all entries

- 1 [☐] or [◀] ☐ → [Menu]
- 2 [↵]: "Erase all" → [Select]
- 3 [↵]: "Yes" → [Select]
- 4 [↵]: "Yes" → [Select] → [OFF]

Chain dial

This feature allows you to dial phone numbers in the phonebook while you are on a call. This feature can be used, for example, to dial a calling card access number or bank account PIN that you have stored in the phonebook, without having to dial manually.

- 1 During an outside call, press [Menu].
- 2 [↵]: "Phonebook" → [Select]
- 3 [↵]: Select the desired entry. → [Select]
- 4 [↵]: Select the desired phone number.
- 5 Press [Call] to dial the number.

Note:

- When storing a calling card access number and your PIN in the phonebook as one phonebook entry, press [▲] (Pause) to add pauses after the number and PIN as necessary (page 14).
- If you have rotary/pulse service, you need to press [☒] (TONE) before pressing [Menu] in step 1 to change the dialing mode temporarily to tone. When adding entries to the phonebook, we recommend adding [☒] (TONE) to the beginning of phone numbers you wish to chain dial (page 17).

Speed dial

You can assign 1 phone number to each of the dial keys ([1] to [9]) on the handset.

Adding phone numbers to speed dial keys

■ By entering phone numbers:

- 1 Press and hold the desired speed dial key ([1] to [9]). → [Add]
- 2 [↵]: "Manual" → [Select]
- 3 Enter the party's name (16 characters max.; page 17). → [OK]
- 4 Enter the party's phone number (24 digits max.). → [OK] → [Select] → [OFF]

■ From the phonebook:

- 1 Press and hold the desired speed dial key ([1] to [9]). → [Add]
- 2 [↵]: "Phonebook" → [Select]
- 3 [↵]: Select the desired entry. → [Select]
- 4 [↵]: Select the desired phone number.
- 5 [Save] → [OFF]

Note:

- If you edit a phonebook entry which is assigned to a speed dial key, the edited entry does not transfer to the speed dial key.

Editing an entry

- 1 Press and hold the desired speed dial key ([1] to [9]). → [Menu]
- 2 [↵]: "Edit" → [Select]
- 3 Edit the name if necessary. → [OK]
- 4 Edit the phone number if necessary. → [OK] → [Select] → [OFF]

Erasing an entry

- 1 Press and hold the desired speed dial key ([1] to [9]). → [Menu]
- 2 [↵]: "Erase" → [Select]
- 3 [↵]: "Yes" → [Select] → [OFF]

Viewing an entry/Making a call

- 1 Press and hold the desired speed dial key (1 to 9).
- 2 To make a call, press .

Menu list

To access the features, there are 2 methods.

■ Scrolling through the display menus

- 1 **[Menu]** (right soft key)
- 2 Press **[▼]**, **[▲]**, **[▶]**, or **[◀]** to select the desired main menu. → **[Select]**
- 3 Press **[▼]** or **[▲]** to select the desired item from the next sub-menus. → **[Select]**
- 4 Press **[▼]** or **[▲]** to select the desired setting. → **[Save]**

■ Using the direct command code

- 1 **[Menu]** (right soft key) → Enter the desired code.
Example: Press **[Menu]** (right soft key) **[#][1][0][1]**.
- 2 Select the desired setting. → **[Save]**

Note:

- To exit the operation, press **[OFF]**.
- In the following table, < > indicates the default settings.
- In the following table,  indicates the reference page number.
- Display menu order and sub-menu may vary depending on your model.

Display the menu tree and direct command code table

Main menu: **→** "Caller list"

Operation	Code	
Viewing the caller list.	#213	33

Main menu: **☐** "Answering device"

Sub-menu 1	Sub-menu 2	Settings	Code	
Message list	–	–	#329	36
Play new message	–	–	#323	36
Play all message	–	–	#324	36
Erase all message* ¹	–	–	#325	37
Greeting	Record greeting* ¹	–	#302	35
	Check greeting	–	#303	36
	Pre-recorded* ¹ (Reset to pre-recorded greeting)	–	#304	35

Programming

Sub-menu 1	Sub-menu 2	Settings	Code	
New message alert	Outgoing call* ¹ – On/Off	1: On 0: <Off>	#338	37
	Outgoing call* ¹ – Notification to	–		
	Outgoing call* ¹ – Remote code	1: Activate 0: <Inactivate>		
	Handset beep	1: On 0: <Off>	#339	37
Settings	Ring count* ¹	2-7: 2-7 rings 4: <4 rings> 0: Toll saver	#211	40
	Recording time* ¹	1: 1 min 3: <3 min> 0: Greeting only* ²	#305	40
	Remote code* ¹	<111>	#306	38
	Screen call	1: <On> 0: Off	#310	40
Answer on* ¹	–	–	#327	35
Answer off* ¹	–	–	#328	35

Main menu:  "Voice Mail access"

Operation	Code	
Listening to voice mail messages.	#330	41

Main menu:  "Intercom"

Operation	Code	
Paging the desired unit.	#274	16

Main menu:  "Set date & time"

Sub-menu 1	Sub-menu 2	Settings	Code	
Date and time* ¹	–	–	#101	12
Memo alarm	1-5: Alarm1-5	1: Once 2: Daily 3: Weekly 0: <Off>	#720	27
Time adjustment* ^{1, *3}	–	1: <Caller ID auto> 0: Manual	#226	–

Main menu:  "Settings"

Sub-menu 1	Sub-menu 2	Settings	Code	
Ring adjustments	Ringer volume	0-6: Off-6 <6>	#160	-
	Ringer tone ^{*4, *5}	<Tone 1>	#161	-
	Silent mode - On/Off	1: On 0: <Off>	#238	27
	Silent mode - Start/End	<11:00 PM/06:00 AM>	#237	28
	Silent mode - Select group	1-9: Group 1-9	#241	28
Set date & time	Date and time ^{*1}	-	#101	12
	Memo alarm - 1-5: Alarm1-5	1: Once 2: Daily 3: Weekly 0: <Off>	#720	27
	Time adjustment ^{*1, *3}	1: <Caller ID auto> 0: Manual	#226	-
Talking Caller ID	-	1: <On> 0: Off	#162	33
Handset name	-	-	#104	31
Key detector setting ^{*6} - 1: Add new device (for Detector1) ^{*7} - 2: Add new device (for Detector2) - 3: Add new device (for Detector3) - 4: Add new device (for Detector4)	Change name ^{*1}	Detector1	#6561	-
		Detector2 ^{*8}	#6562 ^{*9}	
		Detector3 ^{*8}	#6563 ^{*9}	
		Detector4 ^{*8}	#6564 ^{*9}	
	Registration	-	#6571	-
		-	#6572 ^{*9}	
		-	#6573 ^{*9}	
		-	#6574 ^{*9}	
	Deregistration	-	#6581	-
		-	#6582 ^{*9}	
-		#6583 ^{*9}		
-		#6584 ^{*9}		
Call block ^{*1}	-	-	#217	28
	First ring ^{*1}	1: <On> 0: Off	#173	29
	Block w/o num ^{*1, *2} (Block calls without phone number)	1: On 0: <Off>	#240	28
Speed dial	-	-	#261	19

Sub-menu 1	Sub-menu 2	Settings	Code	
Voice mail	Save VM access#* ¹ (VM: Voice mail)	–	#331	41
	VM tone detect* ¹	1: <On> 0: Off	#332	41
Display	Wallpaper	<Wallpaper1>	#181	–
	Clock* ¹⁰	1: Analog (Small) 2: Analog (Large) 3: <Digital (Large)> 4: Digital (Small) 0: Off	#198	–
	Display color	1: <Color1> 2: Color2	#182	–
	Display mode* ¹¹	1: <Multi items> 0: Single item	#192	–
	Key backlight	1: <On> 0: Off	#276	–
	LCD backlight* ¹²	1: <On> 0: Off	#191	–
	LCD contrast (Display contrast)	1-6: Contrast 1-6 <Contrast 3>	#145	–
Auto intercom	–	1: On 0: <Off>	#273	16
Key tone	–	1: <On> 0: Off	#165	–
Caller ID edit (Caller ID number auto edit)	–	1: <On> 0: Off	#214	34
Auto talk* ¹³	–	1: On 0: <Off>	#200	14

Sub-menu 1	Sub-menu 2	Settings	Code	
Set tel line	Set dial mode* ¹	1: Pulse 2: <Tone>	#120	13
	Set flash time* ¹ ,* ¹⁴	0: 900 ms 1: <700 ms> 2: 600 ms 3: 400 ms 4: 300 ms 5: 250 ms *: 200 ms #: 160 ms 6: 110 ms 7: 100 ms 8: 90 ms 9: 80 ms	#121	15
	Set line mode* ¹ ,* ¹⁵	1: A 2: 	#122	–
Call sharing* ¹ ,* ¹⁶	–	1: <On> 0: Off	#194	15
Registration	Register handset	–	#130	32
	Deregistration* ²	–	#131	32
Customer support	–	–	#680	–
Change language	Display	1: <English> 2: Español	#110	12
	Voice prompt* ¹	1: <English> 2: Español	#112	12

Main menu:  “Baby monitor”

Sub-menu 1	Sub-menu 2	Settings	Code	
On/Off	–	1: On 0: <Off>	#268	29
Sensitivity level	–	1: Low 2: <Middle> 3: High	#269	30

Main menu:  “Calendar”

Operation	Code	
Viewing the calendar and setting the schedule alarm.	#727	31

Main menu:  “Key detector”*⁶

Sub-menu 1	Sub-menu 2	Settings	Code	
Search	–	–	#655	–
Battery check	–	–		

Main menu:  "Ring adjustments"^{*17}

Sub-menu 1	Sub-menu 2	Settings	Code	
Ringer volume	–	0-6: Off-6 <6>	#160	–
Ringer tone ^{*4, *5}	–	<Tone 1>	#161	–
Silent mode	On/Off	1: On 0: <Off>	#238	27
	Start/End	<11:00 PM/06:00 AM>	#237	28
	Select group	1-9: Group 1-9	#241	28

- *1 If you program these settings using one of the handsets, you do not need to program the same item using another handset.
- *2 This menu is not displayed when scrolling through the display menus. It is only available in direct command code.
- *3 This feature allows the unit to automatically adjust the date and time each time caller information including date and time is received.
To turn this feature on, select "**Caller ID auto**". To turn this feature off, select "**Manual**". (Caller ID subscribers only)
To use this feature, set the date and time first (page 12).
- *4 If you subscribe to a distinctive ring service (such as IDENT-A-RING), select a tone (tone 1 to 2). If you select a melody, you cannot distinguish lines by their ringers.
- *5 The preset melodies in this product ("**Tone 3**" - "**Melody 30**") are used with permission of © 2012 Copyrights Vision Inc.
- *6 This setting is available when you have the key detector (KX-TGA20). Read the installation manual for more information on the key detector.
- *7 For models with supplied key detectors, the display shows "**1:Detector1**".
- *8 If you register 2 or more key detectors.
- *9 If you have 2 or more key detectors.
- *10 Wallpaper is displayed in the standby mode only when you select "**Digital (Small)**" or "**Off**" for this setting.
- *11 You can select to display either a single item or multiple items on one screen at a time for the handset main menu icons in function menu, recorded message list, phonebook list, caller list, and redial list.
- *12 You can set the handset display backlight while on charge.
– "**On**": Backlight is on (dimmed).
– "**Off**": Backlight turns off after 10 seconds of charging.
- *13 If you subscribe to a Caller ID service and want to view the caller's information after lifting up the handset to answer a call, turn off this feature.
- *14 The flash time depends on your telephone exchange or host PBX. Contact your PBX supplier if necessary. The setting should stay at "**700 ms**" unless pressing [**FLASH**] fails to pick up the waiting call.
- *15 Generally, the line mode setting should not be changed. This setting automatically maintains receiver volume at the proper level depending on the current telephone line condition. Set the line mode to "**A**" if telephone line condition is not good.
- *16 To prevent other users from joining your conversations with outside callers, turn this feature on.
- *17 This menu icon is displayed when the key detector is not registered.

Alarm

An alarm sounds at the set time for 1 minute and is repeated 5 times at 5 minute intervals (snooze function). A text memo can also be displayed for the alarm. A total of 5 separate alarm times can be programmed for each handset. You can set one of 3 different alarm options (once, daily, or weekly) for each alarm time.

Important:

- Make sure the unit's date and time setting is correct (page 12).

- 1 **[Menu]** (right soft key) **# 7 2 0**
- 2 Select an alarm by pressing **1** to **5**. → **[Select]**
- 3 **[↕]**: Select the desired alarm option. → **[Select]**

"Off"	Turns alarm off. Go to step 10.
"Once"	An alarm sounds once at the set time.
"Daily"	An alarm sounds daily at the set time. Go to step 5.
"Weekly"	Alarm sounds weekly at the set time(s).

- 4 Proceed with the operation according to your selection in step 3.
 - **Once:**
Enter the desired month and date. → **[OK]**
 - **Weekly:**
[↕]: Select the desired day of the week and press **[Select]**. → **[OK]**
- 5 Set the desired time.
- 6 **[⊗]**: Select "AM" or "PM". → **[OK]**
- 7 Enter a text memo (30 characters max.). → **[OK]**

- 8 **[↕]**: Select the desired alarm tone. → **[Select]**
 - We recommend selecting a different ringer tone from the one used for outside calls.
- 9 **[↕]**: Select the desired snooze setting. → **[Select]**

10 **[Select]** → **[OFF]**

Note:

- Press **[Stop]** to stop the alarm completely.
- When the handset is in use, the alarm will not sound until the handset is in standby mode.
- Press any dial key or **[Snooze]** to stop the sound but keep the snooze function activated.
- If you want to make an outside call when the snooze function is activated, please stop the snooze function before making the call.

Silent mode

Silent mode allows you to select a period of time during which the handset will not ring for outside calls. This feature is useful for time periods when you do not want to be disturbed, for example, while sleeping. Silent mode can be set for each handset.

Using the phonebook's group feature (page 18), you can also select groups of callers whose calls override silent mode and ring the handset (Caller ID subscribers only).

Important:

- Make sure the unit's date and time setting is correct (page 12).
- If you have set the alarm, the alarm sounds even if the silent mode is turned on.

Turning silent mode on/off

- 1 **[Menu]** (right soft key) **# 2 3 8**
- 2 **[↕]**: Select the desired setting. → **[Save]**
 - If you select "Off", press **[OFF]** to exit.
- 3 Enter the desired hour and minute you wish to start this feature.

- 4 [X]: Select "AM" or "PM". → [OK]
- 5 Enter the desired hour and minute you wish to end this feature.
- 6 [X]: Select "AM" or "PM".
- 7 [Save] → [OFF]

Changing the start and end time

- 1 [Menu] (right soft key) [#][2][3][7]
- 2 Continue from step 3, "Turning silent mode on/off", page 27.

Selecting groups to bypass silent mode

- 1 [Menu] (right soft key) [#][2][4][1]
- 2 Select your desired groups by pressing [1] to [9].
 - "✓" is displayed next to the selected group numbers.
 - To cancel a selected group, press the same dial key again. "✓" disappears.
- 3 [Save] → [OFF]

Call block

This feature allows the unit to reject calls when:

- the unit receives a call from a phone number stored in the call block list as unwanted ("Storing unwanted callers", page 28).
- the unit receives a call without phone number ("Blocking incoming calls without phone number", page 28).

When a call is received, the unit rings for a short time^{*1} while the caller is being identified. If the phone number matches an entry in the call block list, the unit emits no sound to the caller, and disconnects the call. (Caller ID subscribers only)

*1 This is called first ring. If you do not want the first ring to sound, turn this setting to "Off" (page 29).

Important:

- When the unit receives a call from a number that is stored in the call block list or

a call without a recognized phone number, the call is logged in the caller list (page 33) with [V] after the call is disconnected.

Storing unwanted callers

You can store up to 100 phone numbers in the call block list.

Important:

- You must store the phone number with an area code in the call block list.

■ From the caller list:

- 1 [v] CID
- 2 [↕]: Select the entry to be blocked. → [Detail]
 - To edit the number: [Menu] → [↕]: "Edit" → [Select]
Press [Edit] repeatedly until the phone number is shown in the 10-digit format. And then, press [Save]. Go to step 5.
- 3 [Menu]
- 4 [↕]: "Save CID" → [Select]
- 5 [↕]: "Call block" → [Select]
- 6 [↕]: "Yes" → [Select]
- 7 Edit the phone number if necessary (24 digits max.).
- 8 [Save] → [OFF]

■ By entering phone numbers:

- 1 [Menu] (right soft key) [#][2][1][7]
- 2 [Menu] → [↕]: "Add" → [Select]
- 3 Enter the phone number (24 digits max.).
- 4 [Save] → [OFF]

Blocking incoming calls without phone number

You can reject a call when no phone number is provided, such as a call just showing "Out of area".

- 1 [Menu] (right soft key) [#][2][4][0]
- 2 [↕]: Select the desired setting. → [Save]

3 [OFF]

Setting the first ring for the call block list

If you do not want the first ring from a number on the call block list to sound, turn the first ring setting to "Off". The default setting is "On".

- 1 **[Menu]** (right soft key) **#173**
- 2 **[↓]**: Select the desired setting. → **[Save]**
- 3 **[OFF]**

Viewing/editing/erasing call block numbers

- 1 **[Menu]** (right soft key) **#217**
- 2 **[↓]**: Select the desired entry.
 - To exit, press **[OFF]**.
- 3 **To edit a number:**
[Edit] → Edit the phone number. → **[Save]** → **[OFF]**
To erase a number:
[Erase] → **[↓]**: "Yes" → **[Select]** → **[OFF]**

Baby monitor

This feature allows you to listen in on a room where another handset is located, allowing you to easily monitor from different areas of the house or place. The monitored handset (placed in a baby's room, for example) will automatically call the monitoring handset or the phone number stored when it detects sound.

Important:

- You should perform a test run of the baby monitor procedure to ensure that the baby monitor feature is set correctly. For example, test its sensitivity. Check the connection if you are diverting the baby monitor to an outside line.

Note:

- If the unit is connected to a PBX system, you cannot set the baby monitor.

- During the monitoring mode, battery consumption is faster than usual. We recommend leaving the monitored handset on the base unit or charger.
- The monitored handset never rings during the monitoring mode.

Setting the baby monitor

Perform the setting operation with the handset to be monitored (for example, the handset placed in a baby's room).

To monitor with a handset

The internal baby monitor feature is only available between handsets in the same radio cell.

- 1 **[Menu]** (right soft key) **#268**
- 2 **[↓]**: "On" → **[Select]**
- 3 **[↓]**: Select the desired handset number to monitor with. → **[Save]**
 - "Baby monitor" will be displayed.
 - The registered handset name/number is displayed.

Note:

- When this feature is on, another handset can hear the monitored handset by making an intercom call.

To monitor from an outside line**■ From the phonebook:**

- 1 **[Menu]** (right soft key) **#268**
- 2 **[↓]**: "On" → **[Select]**
- 3 **[↓]**: Select "External" to monitor from an outside line. → **[Edit]** → **[Add]**
- 4 **[↓]**: "Phonebook" → **[Select]**
- 5 **[↓]**: Select the phonebook entry. → **[Select]**
- 6 **[↓]**: Select the desired phone number. → **[Save]**
 - "Baby monitor" will be displayed.

Note:

- If you edit a phonebook entry which is assigned for monitoring, the edited entry does not transfer to the monitor.

■ By entering phone numbers:

- 1 **[Menu]** (right soft key) **[#][2][6][8]**
- 2 **[↕]**: "On" → **[Select]**
- 3 **[↕]**: Select "External" to monitor from an outside line. → **[Edit]** → **[Add]**
- 4 **[↕]**: "Manual" → **[Select]**
- 5 Enter the desired name. → **[OK]**
- 6 Enter the desired number. → **[OK]** → **[Select]**
 - "Baby monitor" will be displayed.

Note:

- The registered name/number is displayed.

Turning off the baby monitor

The monitored handset cannot be used while baby monitor is set to "On".

- 1 Press **[Menu]** on the handset being monitored.
- 2 **[↕]**: "On/Off" → **[Select]**
- 3 **[↕]**: "Off" → **[Select]** → **[OFF]**

Editing an outside monitoring number

- 1 Press **[Menu]** on the handset being monitored.
- 2 **[↕]**: "On/Off" → **[Select]**
- 3 **[↕]**: "On" → **[Select]**
- 4 **[↕]**: Select the outside line. → **[Edit]**
- 5 **[Menu]** → **[↕]**: "Edit" → **[Select]**
- 6 Edit the name if necessary. → **[OK]**
- 7 Edit the phone number if necessary. → **[OK]** → **[Select]**

Erasing an outside monitoring number

- 1 Press **[Menu]** on the handset being monitored.

- 2 **[↕]**: "On/Off" → **[Select]**
- 3 **[↕]**: "On" → **[Select]**
- 4 **[↕]**: Select the outside line. → **[Edit]**
- 5 **[Menu]** → **[↕]**: "Erase" → **[Select]**
- 6 **[↕]**: "Yes" → **[Select]** → **[OFF]**

Baby monitor sensitivity

You can adjust the sensitivity of the baby monitor. Increase or decrease the sensitivity to adjust the sound level needed to trigger the baby monitor feature.

- This feature cannot be set during a monitoring call.
- 1 Press **[Menu]** on the handset being monitored.
 - 2 **[↕]**: "Sensitivity level" → **[Select]**
 - 3 **[↕]**: Select the desired setting. → **[Save]** → **[OFF]**

Answering the baby monitor

■ When monitoring with a handset:

Press **[↵]** to answer calls.

If you want to respond from the monitoring handset, press **[Mute]**.

- The monitoring handset will answer calls automatically when the auto intercom feature is set to "On" (page 16).

Note:

- If you receive an outside call when communicating with the monitored handset, you hear 2 tones. To answer the call, press **[OFF]**, then press **[↵]**.

■ When monitoring from an outside line:

To answer a call, follow the operation for your phone.

If you want to respond from the monitoring handset, press **[#][1]** using tone dialing.

You can turn off the baby monitor feature by pressing **[#][0]**.

Note:

- 2 minutes after the monitored handset starts a call, communication between the monitored handset and monitoring phone line is turned off automatically.

Other programming

Changing the handset name

Each handset can be given a customized name ("Bob", "Kitchen", etc.). This is useful when you make intercom calls between handsets. You can also select whether or not the handset name is displayed in standby mode. The default setting is "No". If you select "Yes" without entering any handset name, "Handset 1" to "Handset 6" is displayed.

- 1 **[Menu]** (right soft key) $\boxed{\#104}$
- 2 Enter the desired name (max. 10 characters).
- 3 **[Save]**
- 4 $\boxed{\uparrow}$: Select the desired setting. \rightarrow **[Select]** 2 times \rightarrow **[OFF]**

Calendar/Schedule

You can program 20 schedule alarms for each handset using the calendar. A schedule alarm sounds at the set time for 1 minute. A text memo can also be displayed for the schedule alarm.

Important:

- Make sure the unit's date and time setting is correct (page 12).

Adding a new entry

- 1 **[Menu]** (right soft key) \rightarrow $\boxed{\text{☰}}$ \rightarrow **[Select]**
- 2 $\boxed{\uparrow}$: Select the desired date. \rightarrow **[Select]**
- 3 **[Menu]** \rightarrow $\boxed{\uparrow}$: "Add new entry" \rightarrow **[Select]**
- 4 Edit the date if necessary. \rightarrow **[OK]**
- 5 Set the desired time. \rightarrow **[OK]**
- 6 Enter a text memo (30 characters max.; page 17). \rightarrow **[OK]**
- 7 $\boxed{\uparrow}$: Select the desired alarm tone. \rightarrow **[Select]** 2 times
 - You can select "OFF" if you prefer not to hear an alarm tone.

- We recommend selecting a different ringer tone from the one used for outside calls.

8 [OFF]

Note:

- To stop the alarm, press **[Stop]** or place the handset on the base unit or charger.
- When the handset is in use, the alarm will not sound until the handset is in standby mode.

Viewing entries

- 1 **[Menu]** (right soft key) \rightarrow $\boxed{\text{☰}}$ \rightarrow **[Select]**
- 2 To see the entries on the selected date, press **[Select]**.
To see the schedule list, press **[List]**.
 - You can see detailed information about the schedule by pressing **[Menu]**. \rightarrow $\boxed{\uparrow}$: "Detail" \rightarrow **[Select]**

Editing an entry

- 1 **[Menu]** (right soft key) \rightarrow $\boxed{\text{☰}}$ \rightarrow **[Select]**
- 2 **[List]** \rightarrow $\boxed{\uparrow}$: Select the desired entry.
- 3 **[Menu]** \rightarrow $\boxed{\uparrow}$: "Edit" \rightarrow **[Select]**
- 4 Edit the date if necessary. \rightarrow **[OK]**
- 5 Edit the time if necessary. \rightarrow **[OK]**
- 6 Edit the text memo if necessary (30 characters max.). \rightarrow **[OK]**
- 7 $\boxed{\uparrow}$: Select the desired alarm tone. \rightarrow **[Select]** 2 times \rightarrow **[OFF]**

Erasing an entry

Schedule alarm entries are not erased automatically after the schedule alarm sounds. Erase unwanted entries.

- 1 **[Menu]** (right soft key) \rightarrow $\boxed{\text{☰}}$ \rightarrow **[Select]**
- 2 **[List]** \rightarrow $\boxed{\uparrow}$: Select the desired entry.
- 3 **[Menu]** \rightarrow $\boxed{\uparrow}$: "Erase" \rightarrow **[Select]**
- 4 $\boxed{\uparrow}$: "Yes" \rightarrow **[Select]** \rightarrow **[OFF]**

Erasing all entries

- 1 **[Menu]** (right soft key) →  → **[Select]**
- 2 **[List]** → **[Menu]**
- 3 **[↓]**: "Erase all" → **[Select]**
- 4 **[↓]**: "Yes" → **[Select]**
- 5 **[↓]**: "Yes" → **[Select]** → **[OFF]**

Registering a unit

Operating additional units

Additional handsets





Up to 6 handsets can be registered to the base unit.

Important:

- The additional handset model recommended for use with this unit is noted on page 4. If another handset model is used, certain operations may not be available.



Registering a handset to the base unit

The supplied handset and base unit are pre-registered. If for some reason the handset is not registered to the base unit (for example,  is displayed even when the handset is near the base unit), re-register the handset.

- 1 **Handset:**
[Menu] (right soft key)  **1**  **3**  **0**
- 2 **Base unit:**
Press and hold  for about 5 seconds.
 - If all registered handsets start ringing, press  again to stop, then repeat this step.
- 3 **Handset:**
Press **[OK]**, then wait until a long beep sounds.

Deregistering a handset

A handset can cancel its own registration to the base unit, or other handsets registered to the same base unit. This allows the handset to end its wireless connection with the system.

- 1 **[Menu]** (right soft key)  **1**  **3**  **1**
 - All handsets registered to the base unit are displayed.
- 2 **[↓]**: Select the handset you want to cancel. → **[Select]**
- 3 **[↓]**: "Yes" → **[Select]**
- 4 **[OFF]**

Using Caller ID service

Important:

- This unit is Caller ID compatible. To use Caller ID features, you must subscribe to a Caller ID service. Contact your service provider/telephone company for details.

Caller ID features

When an outside call is being received, the caller information is displayed.

Caller information for the last 50 callers is logged in the caller list from the most recent call to the oldest.

- If the unit cannot receive caller information, the following is displayed:
 - “**Out of area**”: The caller dials from an area which does not provide a Caller ID service.
 - “**Private caller**”: The caller requests not to send caller information.
 - “**Long distance**”: The caller makes a long distance call.
- If the unit is connected to a PBX system, caller information may not be properly received. Contact your PBX supplier.

Missed calls

If a call is not answered, the unit treats it as a missed call and “**Missed call**” is displayed. This lets you know if you should view the caller list to see who called while you were away.

Even if only one missed call in the caller list is viewed (page 33), “**Missed call**” disappears from the display. When you receive another new call, “**Missed call**” is displayed again.

Note:

- Even when there are unviewed missed calls, “**Missed call**” disappears from the standby display if the following operation is performed by one of the registered handsets:
 - Being replaced on the base unit or charger.
 - Pressing [OFF].

Phonebook name display

When caller information is received and it matches a phone number stored in the phonebook, the stored name in the phonebook is displayed and logged in the caller list.

Talking Caller ID

This feature lets you know who is calling without looking at the display.

To use this feature, you must:

- subscribe to a Caller ID service of your service provider/telephone company.
- turn this feature on (page 23).

When caller information is received, the handsets announce the caller’s name or phone number received from your service provider/telephone company following every ring.

The unit announces in English only.

- Name pronunciation may vary. This feature may not pronounce all names correctly.
- Caller ID service has a limit of how many characters can be displayed. If the caller’s name is too long, the unit may not be able to display or announce the entire name.

Phonebook name announcement

When caller information is received and it matches a phone number stored in the phonebook, the stored name in the phonebook is announced.

Caller list

Important:

- Make sure the unit’s date and time setting is correct (page 12).

Viewing the caller list and calling back

1 [v] CID

- Press **[▼]** to search from the most recent call, or press **[▲]** to search from the oldest call.
 - You can see the detailed information about the caller by pressing **[Detail]** when in multiple display mode.
- To call back, press **[↶]**.
To exit, press **[OFF]**.

Note:

- If the entry has already been viewed or answered, "✓" is displayed.

Editing a caller's phone number

You can edit a phone number in the caller list by removing its area code and/or the long distance code "1".

- [▼]** CID
- [↕]**: Select the desired entry. → **[Detail]**
- [Menu]** → **[↕]**: "Edit" → **[Select]**
- Press **[Edit]** repeatedly until the phone number is shown in the desired format.
- [↶]**

Note:

- The number edited in step 4 will not be saved in the caller list.

Caller ID number auto edit feature

Once you call back an edited number, the unit which was used to call back remembers the area code and format of the edited number. The next time someone calls from the same area code, caller information is customized by the unit as follows:

- When the call is being received, the Caller ID number is displayed in the same format as the edited number.
- After the call has ended, the caller's phone number is displayed in the same format as the edited number, when reviewed from the caller list.

For example, you can use this feature to set the unit to ignore the area code of callers in your area, so that you can call these local numbers using caller information without dialing the area code.

To activate this feature, you must edit an entry in the caller list, then call that number. After that, phone numbers from that caller's area code are edited automatically. This feature can be set for each unit (page 24). The default setting is "On".

Note:

- Phone numbers from the 4 most recently edited area codes are automatically edited.

Erasing selected caller information

- [▼]** CID
- [↕]**: Select the desired entry.
- [Erase]** → **[↕]**: "Yes" → **[Select]** → **[OFF]**

Erasing all caller information

- [▼]** CID
- [Erase]** → **[↕]**: "Yes" → **[Select]** → **[OFF]**

Answering system

The answering system can answer and record calls for you when you are unavailable to answer the phone.

You can also set the unit to play a greeting message but not to record caller messages by selecting **"Greeting only"** as the recording time setting (page 40).

Important:

- Make sure the unit's date and time setting is correct (page 12).

Memory capacity (including your greeting message)

The total recording capacity is about 38 minutes. A maximum of 64 messages can be recorded.

Note:

- When message memory becomes full:
 - **"Messages full"** is shown on the handset display.
 - If you use the pre-recorded greeting message, the unit automatically switches to another pre-recorded greeting message asking callers to call again later.
 - If you recorded your own greeting message, the same message is still announced to callers even though their messages are not recorded.

Turning the answering system on/off

The answering system is preset to on.

- To turn on:**
[Menu] (right soft key) **#327**
To turn off:
[Menu] (right soft key) **#328**
- [OFF]**

Note:

- When the answering system is turned on, **AD** is displayed.

Greeting message

When the unit answers a call, a greeting message is played to callers.

You can use either:

- your own greeting message
- a pre-recorded greeting message

Recording your greeting message

- [Menu]** (right soft key) **#302**
- [↓]: "Yes" → [Select]**
- After a beep sounds, hold the handset about 20 cm (8 inches) away and speak clearly into the microphone (2 minutes max.).
- Press **[Stop]** to stop recording. → **[OFF]**

Using a pre-recorded greeting message

The unit provides 2 pre-recorded greeting messages:

- If you erase or do not record your own greeting message, the unit plays a pre-recorded greeting asking callers to leave a message.
- If the message recording time (page 40) is set to **"Greeting only"**, callers' messages are not recorded and the unit plays a different pre-recorded greeting message asking callers to call again.

Resetting to a pre-recorded greeting message

If you want to use a pre-recorded greeting message once you record your own greeting message, you need to erase your own greeting message.

- [Menu]** (right soft key) **#304**
- [Yes] → [OFF]**

Playing back the greeting message

- 1 **[Menu]** (right soft key) **# 3 0 3**
- 2 To exit, press **[OFF]**.

Listening to messages

When new messages have been recorded, "New message" is displayed on the handset.

- 1 **To listen to new messages:**
[Play]^{*1}
or
[Menu] (right soft key) **# 3 2 3**
To listen to all messages:
[Menu] (right soft key) **# 3 2 4**
 - 2 When finished, press **[OFF]**
- *1 If there are no new messages in the answering system, **[Play]** is not displayed.

Note:

- To switch to the receiver, press **[↶]**.

Listening to messages from the message list

You can select the item to play back.

- 1 **[Menu]** (right soft key) **# 3 2 9**
- 2 **[↕]**: Select the desired item from the message list. → **[Play]**
 - You can erase the selected message as follows:
[Menu] → **[↕]**: "Erase" → **[Select]**
→ **[↕]**: "Yes" → **[Select]**
- 3 When finished, press **[OFF]**

Note:

- If the item has already been heard, "✓" is displayed, even if it was heard using another handset.
- "Message" is displayed in the message list if the unit cannot receive caller information.

Operating the answering system

[Menu] (right soft key) → **[0]** → **[Select]**

Key	Operation
[▲] or [▼]	Adjust the receiver or speaker volume (during playback)
[1] or [◀]	Repeat message (during playback) ^{*1}
[2] or [▶]	Skip message (during playback) ^{*2}
[3]	Enter the "Settings" menu
[4]	Play new messages
[5]	Play all messages
[6]	Play greeting message
[7][6]	Record greeting message
[8]	Turn answering system on
[Pause]	Pause message ^{*3}
[9] or [Stop]	Stop recording Stop playback
[0]	Turn answering system off
[*][4] ^{*4}	Erase currently playing message
[*][5]	Erase all messages
[*][6]	Reset to a pre-recorded greeting message

- *1 If pressed within the first 5 seconds of a message, the previous message is played except when playing back from the message list.
- *2 When you play a message from the message list, the unit stops message playback and the display goes back to the message list.
- *3 To resume playback:
[↕]: "Playback" → **[Select]**
- *4 You can also erase as follows:
[Pause] → **[↕]**: "Erase" → **[Select]**
→ **[↕]**: "Yes" → **[Select]**

Rewinding the message

Press and hold **[◀]** until the unit plays the desired part of the message.

- During rewinding, the handset makes a continuous beeping sound. Rewinding speed may vary depending on the recorded message.
- At the beginning of the message, the unit plays the message at normal speed.

Fast-forwarding the message

Press and hold **[▶]** until the unit plays the desired part of the message.

- During fast-forwarding, the handset makes a continuous beeping sound. Fast-forwarding speed may vary depending on the recorded message.
- Even if you press and hold **[▶]** when the end of this message is played, the next message is played at normal speed.

Calling back (Caller ID subscribers only)

- 1 Press **[Pause]** during playback.
- 2 **[↕]**: "Call back" → **[Select]**

Editing the number before calling back

- 1 Press **[Pause]** during playback.
- 2 **[↕]**: "Edit & Call" → **[Select]**
- 3 Press **[Edit]** repeatedly until the phone number is shown in the desired format (page 34). → **[↶]**

Erasing all messages

- 1 **[Menu]** (right soft key) **[#][3][2][5]**
- 2 **[↕]**: "Yes" → **[Select]** → **[OFF]**

Advanced new message alerting features

Audible message alert

This feature allows the handset to beep to inform you of a new message arrival when new messages are recorded. The handset

beeps 2 times every minute until you listen to the messages, if the "Handset beep" setting is turned on. The default setting is "Off".

- 1 **[Menu]** (right soft key) **[#][3][3][9]**
- 2 **[↕]**: Select the desired setting. → **[Save]** → **[OFF]**

New message alert by a call

This feature allows you to receive a notification by phone when new messages are recorded. The base unit calls a phone number you specify. You can then operate the answering system remotely to listen to the new message.

To use this feature, you must:

- store a phone number to which the unit makes the call to.
- turn on the new message alert setting.

After you answer the new message alert call, you can listen to messages from that call (page 38).

Important:

- A new message alert is stopped 1 minute after the unit starts to call. The unit will not retry the call even if the call is not answered.

Storing a phone number to which the unit makes an alert call

■ From the phonebook:

- 1 **[Menu]** (right soft key) **[#][3][3][8]**
- 2 **[↕]**: "Notification to" → **[Select]** → **[Add]**
- 3 **[↕]**: "Phonebook" → **[Select]**
- 4 **[↕]**: Select the desired phonebook entry. → **[Select]**
- 5 **[↕]**: Select the desired phone number. → **[Save]** → **[OFF]**

■ By entering a phone number:

- 1 **[Menu]** (right soft key) **[#][3][3][8]**
- 2 **[↕]**: "Notification to" → **[Select]** → **[Add]**
- 3 **[↕]**: "Manual" → **[Select]**

- 4 Enter the desired name (16 characters max.). → **[OK]**
- 5 Enter the desired number (24 digits max.). → **[OK]** → **[Select]** → **[OFF]**

Turning on/off the new message alert setting

- 1 **[Menu]** (right soft key) **# [3] [3] [8]**
- 2 **[↕]**: “On/Off” → **[Select]**
- 3 **[↕]**: Select the desired setting. → **[Save]** → **[OFF]**

Editing the set phone number

- 1 **[Menu]** (right soft key) **# [3] [3] [8]**
- 2 **[↕]**: “Notification to” → **[Select]**
- 3 **[Menu]** → **[↕]**: “Edit” → **[Select]**
- 4 Edit the name if necessary (16 characters max.). → **[OK]**
- 5 Edit the phone number if necessary (24 digits max.). → **[OK]** → **[Select]** → **[OFF]**

Erasing the set phone number

- 1 **[Menu]** (right soft key) **# [3] [3] [8]**
- 2 **[↕]**: “Notification to” → **[Select]**
- 3 **[Menu]** → **[↕]**: “Erase” → **[Select]**
- 4 **[↕]**: “Yes” → **[Select]** → **[OFF]**
 - The new message alert setting is turned off.

Activating/inactivating the remote access code to play messages

If you activate this feature, you must enter the remote access code (page 38) to play the new message from the new message alert call. This is so that unauthorized parties cannot listen to your messages. The default setting is “Inactivate”.

- “Inactivate”: You can listen to the message by pressing **[4]** to play new messages (without entering the remote access code).

- “Activate”: You must enter your remote access code (page 38) and then press **[4]** to play new message.

- 1 **[Menu]** (right soft key) **# [3] [3] [8]**
- 2 **[↕]**: “Remote code” → **[Select]**
- 3 **[↕]**: “Activate” or “Inactivate” → **[Save]** → **[OFF]**

Listening to messages

After you answer the new message alert, you can listen to the messages as follows.

- **When the remote access code is set to “Inactivate”:**
Press **[4]** to play the new message during the announcement.
- **When the remote access code is set to “Activate”:**
 - 1 Enter the remote access code (page 38) during the announcement.
 - 2 Press **[4]** to play the new message.

Note:

- Within 10 seconds after listening to new messages, you can press **[#] [9]** during the call to turn off the new message alert by a call feature.
- Even if the unit makes a new message alert call, the handset redial list does not show the record.

Remote operation

Using a touch-tone phone, you can call your phone number from outside and access the unit to listen to messages or change answering system settings. The unit's voice guidance prompts you to press certain dial keys to perform different operations.

Remote access code

A 3-digit remote access code must be entered when operating the answering system remotely. This code prevents unauthorized parties from listening to your messages remotely. The default setting is “111”.

Important:

- To prevent unauthorized access to this product, we recommend that you regularly change the remote code.

- 1 [Menu]** (right soft key) **[#] [3] [0] [6]**
- 2** Enter the desired 3-digit remote access code.
- 3 [Save]** → **[OFF]**

Deactivating remote operation

Press **[X]** in step 2 on "Remote access code", page 38.

- The entered remote access code is deleted.

Using the answering system remotely

- 1** Dial your phone number from a touch-tone phone.
- 2** After the greeting message starts, enter your remote access code.
- 3** Follow the voice guidance prompts as necessary or control the unit using remote commands (page 39).
- 4** When finished, hang up.

Voice guidance

■ When the English voice guidance is selected

During remote operation, the unit's voice guidance starts and prompts you to press **[1]** to perform a specific operation, or press **[2]** to listen to more available operations.

■ When the Spanish voice guidance is selected

To start the voice guidance, press **[9]**. The voice guidance announces the available remote commands (page 39).

Note:

- If you do not press any dial keys within 10 seconds after a voice guidance prompt, the unit disconnects your call.

Remote commands

You can press dial keys to access certain answering system functions without waiting for the voice guidance to prompt you.

Key	Operation
[1]	Repeat message (during playback)*1
[2]	Skip message (during playback)
[4]	Play new messages
[5]	Play all messages
[9]	Stop playback*2 Start voice guidance*3
[0]	Turn answering system off
[X] [4]	Erase currently playing message
[X] [5]	Erase all messages
[X] [#]	End remote operation (or hang up)

*1 If pressed within the first 5 seconds of a message, the previous message is played.

*2 For English voice guidance only

*3 For Spanish voice guidance only

Turning on the answering system remotely

- 1** Dial your phone number from a touch-tone phone.
- 2** Let the phone ring 15 times.
 - A long beep is heard.
- 3** Enter your remote access code within 10 seconds after the long beep.
 - The greeting message is played back.
 - You can either hang up, or enter your remote access code again and begin remote operation (page 38).

Answering system settings

Call screening

While a caller is leaving a message, you can listen to the call through the handset's speaker. To adjust the speaker volume, press [▲] or [▼] repeatedly. You can answer the call by pressing [↶] on the handset. Call screening can be set for each handset. The default setting is "On".

- 1 [Menu] (right soft key) #310
- 2 [↕]: Select the desired setting. → [Save] → [OFF]

Number of rings before the unit answers a call

You can change the number of times the phone rings "Ring count" before the unit answers calls. You can select 2 to 7 rings, or "Toll saver".

The default setting is "4 rings".

"Toll saver": The unit's answering system answers at the end of the 2nd ring when new messages have been recorded, or at the end of the 5th ring when there are no new messages. If you call your phone from outside to listen to new messages (page 39), you know that there are no new messages when the phone rings for the 3rd time. You can then hang up without being charged for the call.

- 1 [Menu] (right soft key) #211
- 2 [↕]: Select the desired setting. → [Save] → [OFF]

For voice mail service subscribers

If you subscribe to a flat-rate service package that includes Caller ID, call waiting, voice mail, and unlimited local/regional/long distance calls, please note the following:

- To use the voice mail service provided by your service provider/telephone company rather than the unit's answering system, turn off the answering system (page 35).
- To use this unit's answering system rather than the voice mail service provided by

your service provider/telephone company, please contact your service provider/telephone company to deactivate your voice mail service.

If your service provider/telephone company cannot do this:

- Set this unit's "Ring count" setting so that this unit's answering system answers calls before the voice mail service of your service provider/telephone company does. It is necessary to check the number of rings required to activate the voice mail service provided by your service provider/telephone company before changing this setting.
- Change the number of rings of the voice mail service so that the answering system can answer the call first. To do so, contact your service provider/telephone company.

Caller's recording time

You can change the maximum message recording time allowed for each caller. The default setting is "3 min".

- 1 [Menu] (right soft key) #305
- 2 [↕]: Select the desired setting. → [Save] → [OFF]

Selecting "Greeting only"

You can select "Greeting only" which sets the unit to announce a greeting message to callers but not record messages.

Select "Greeting only" in step 2 on "Caller's recording time", page 40.

Note:

- When you select "Greeting only":
 - If you do not record your own message, the unit will play the pre-recorded greeting-only message asking callers to call again later.
 - If you use your own message, record the greeting-only message asking callers to call again later (page 35).

Voice mail service

Voice mail is an automatic answering service offered by your service provider/telephone company. After you subscribe to this service, your service provider/telephone company's voice mail system answers calls for you when you are unavailable to answer the phone or when your line is busy. Messages are recorded by your service provider/telephone company, not your telephone. Please contact your service provider/telephone company for details of this service.

Important:

- To use the voice mail service provided by your service provider/telephone company rather than the unit's answering system, turn off the answering system (page 35). For details, see page 40.

Storing the voice mail (VM) access number

In order to listen to your voice mail messages, you must dial your service provider/telephone company's voice mail access number. Once you have stored your voice mail access number, you can dial it automatically (page 41).

- [Menu]** (right soft key) **#3331**
- Enter your access number (24 digits max.). → **[Save]** → **[OFF]**

Note:

- When storing your voice mail access number and your mailbox password, press **[▲]** (Pause) to add pauses (page 14) between the access number and the password as necessary. Contact your service provider/telephone company for the required pause time.

Example:

1-222-333-4444	PPPP	8888
VM access	Pauses	Password
number		

To erase the voice mail access number

- [Menu]** (right soft key) **#3331**
- Press and hold **[Clear]** until all digits are erased. → **[Save]** → **[OFF]**

Voice mail (VM) tone detection

Your service provider/telephone company sends special signals (sometimes called "voice mail tones" or "stutter tones") to the unit to let you know you have new voice mail messages. If you hear a series of dial tones followed by a continuous dial tone after you press **[📞]**, you have new voice mail messages. Soon after you hang up a call or after the phone stops ringing, your unit checks the phone line to see if new voice mail messages have been recorded.

Turn this feature off when:

- You do not subscribe to voice mail service.
- Your service provider/telephone company does not send voice mail tones.
- Your phone is connected to a PBX.

If you are not sure which setting is required, contact your service provider/telephone company.

Turning VM tone detection on/off

The default setting is "On".

- [Menu]** (right soft key) **#3332**
- [↕]**: Select the desired setting. → **[Save]** → **[OFF]**

Listening to voice mail messages

The unit lets you know that you have new voice mail messages in the following way:

- "New Voice Mail" is displayed if message indication service is available.
- [VM]*1**
or
[Menu] (right soft key) **#3330**
 - The speakerphone turns on.
 - Follow the pre-recorded instructions.
 - When finished, press **[OFF]**.

Useful Information

*1 If there are no new messages in the voice mail, **[VM]** is not displayed.

Note:

- If the handset still indicate there are new messages even after you have listened to

all new messages, turn it off by pressing and holding **[#]** until the handset beeps.

Error messages

Display message	Cause/solution
Ask phone company for VM access #	<ul style="list-style-type: none">● You have not stored the voice mail access number. Store the number (page 41).
Base no power or No link to base. Reconnect main base AC adaptor.	<ul style="list-style-type: none">● The handset has lost communication with the base unit. Move closer to the base unit and try again.● Unplug the base unit's AC adaptor to reset the unit. Reconnect the adaptor and try again.● The handset's registration may have been canceled. Re-register the handset (page 32).
Busy	<ul style="list-style-type: none">● The called unit is in use.● Other units are in use and the system is busy. Try again later.● The handset you are using is too far from the base unit. Move closer and try again.
Check tel line	<ul style="list-style-type: none">● The supplied telephone line cord has not been connected yet or not connected properly. Check the connections (page 9).
Error!!	<ul style="list-style-type: none">● Recording was too short. Try again.
Invalid	<ul style="list-style-type: none">● There is no handset registered to the base unit matching the handset number you entered.● The handset is not registered to the base unit. Register the handset (page 32).
Memory full	<ul style="list-style-type: none">● The phonebook memory is full. Erase unwanted entries (page 18).● Message memory is full. Erase unwanted messages (page 36).● The call block list memory is full. Erase unwanted entries (page 29).● The schedule alarm memory is full. Erase unwanted entries (page 31).
Requires subscription to Caller ID.	<ul style="list-style-type: none">● You must subscribe to a Caller ID service. Once you receive caller information after subscribing to a Caller ID service, this message will not be displayed.
Use rechargeable battery.	<ul style="list-style-type: none">● A wrong type of battery such as Alkaline or Manganese was inserted. Use only the rechargeable Ni-MH batteries noted on page 3, 6.

Troubleshooting

If you still have difficulties after following the instructions in this section, disconnect the base unit's AC adaptor, then reconnect the base unit's AC adaptor. Remove the batteries from the handset, and then insert the batteries into the handset again.

General use

Problem	Cause/solution
The handset does not turn on even after installing charged batteries.	<ul style="list-style-type: none"> Place the handset on the base unit or charger to turn on the handset.
The unit does not work.	<ul style="list-style-type: none"> Make sure the batteries are installed correctly (page 9). Fully charge the batteries (page 10). Check the connections (page 9). Unplug the base unit's AC adaptor to reset the unit. Reconnect the adaptor and try again. The handset has not been registered to the base unit. Register the handset (page 32).
The handset display is blank or dark.	<ul style="list-style-type: none"> The handset is in screen saver mode (page 12). Activate the handset display again by: <ul style="list-style-type: none"> pressing  when on a call. pressing [OFF] at all other times. "LCD backlight" is set to "OFF" while on charge. Change the setting (page 24).
I cannot hear a dial tone.	<ul style="list-style-type: none"> Make sure that you are using the supplied telephone line cord. Your old telephone line cord may have a different wiring configuration. The base unit's AC adaptor or telephone line cord is not connected. Check the connections. Disconnect the base unit from the telephone line and connect the line to a known working telephone. If the working telephone operates properly, contact our service personnel to have the unit repaired. If the working telephone does not operate properly, contact your service provider/telephone company.
The handset beeps.	<ul style="list-style-type: none"> New messages have been recorded. Listen to the new messages (page 36).
The handset display begins operating automatically.	<ul style="list-style-type: none"> Demonstration mode is activated. Remove the batteries from the handset, and then insert the batteries into the handset again.



Menu list

Problem	Cause/solution
The display is in a language I cannot read.	<ul style="list-style-type: none"> Change the display language (page 12).

Useful Information

Problem	Cause/solution
I cannot display the wallpaper.	<ul style="list-style-type: none">● Wallpaper is displayed in the standby mode only when you select "Digital (Small)" or "Off" for the clock setting. Change the clock setting (page 24).
I cannot register a handset to a base unit.	<ul style="list-style-type: none">● The maximum number of handsets (6) is already registered to the base unit. Cancel unused handset registrations from the base unit (page 32).

Battery recharge

Problem	Cause/solution
The handset beeps and/or  flashes.	<ul style="list-style-type: none">● Battery charge is low. Fully charge the batteries (page 10).
I fully charged the batteries, but <ul style="list-style-type: none">–  still flashes,–  is displayed, or– the operating time seems to be shorter.	<ul style="list-style-type: none">● Clean the battery ends (+, -) and the charge contacts with a dry cloth and charge again.● It is time to replace the batteries (page 9).

Making/answering calls, intercom

Problem	Cause/solution
 is displayed.	<ul style="list-style-type: none">● The handset is too far from the base unit. Move closer.● The base unit's AC adaptor is not properly connected. Reconnect AC adaptor to the base unit.● The handset is not registered to the base unit. Register it (page 32).
Noise is heard, sound cuts in and out.	<ul style="list-style-type: none">● You are using the handset or base unit in an area with high electrical interference. Re-position the base unit and use the handset away from sources of interference.● Move closer to the base unit.● If you use a DSL/ADSL service, we recommend connecting a DSL/ADSL filter between the base unit and the telephone line jack. Contact your DSL/ADSL provider for details.
The handset does not ring.	<ul style="list-style-type: none">● The ringer volume is turned off. Adjust ringer volume (page 14, 23).● Silent mode is turned on. Turn it off (page 27).
I cannot make a call.	<ul style="list-style-type: none">● The dialing mode may be set incorrectly. Change the setting (page 13).
I cannot make long distance calls.	<ul style="list-style-type: none">● Make sure that you have long distance service.

Caller ID/Talking Caller ID

Problem	Cause/solution
Caller information is not displayed.	<ul style="list-style-type: none"> ● You must subscribe to a Caller ID service. Contact your service provider/telephone company for details. ● If your unit is connected to any additional telephone equipment such as a Caller ID box or cordless telephone line jack, plug the unit directly into the wall jack. ● If you use a DSL/ADSL service, we recommend connecting a DSL/ADSL filter between the base unit and the telephone line jack. Contact your DSL/ADSL provider for details. ● The name display service may not be available in some areas. Contact your service provider/telephone company for details. ● Other telephone equipment may be interfering with this unit. Disconnect the other equipment and try again.
Caller information is displayed or announced late.	<ul style="list-style-type: none"> ● Depending on your service provider/telephone company, the unit may display or announce the caller's information at the 2nd ring or later. ● Move closer to the base unit.
Caller information is not announced.	<ul style="list-style-type: none"> ● The handset ringer volume is turned off. Adjust it (page 14, 23). ● The Talking Caller ID feature is turned off. Turn it on (page 23). ● The number of rings for the answering system is set to "2 rings" or "Toll saver". Select a different setting (page 40).
The caller list/incoming phone numbers are not edited automatically.	<ul style="list-style-type: none"> ● The Caller ID number auto edit feature is turned off. Turn it on and try again (page 24). ● You need to call back the edited number to activate Caller ID number auto edit.
I cannot dial the phone number edited in the caller list.	<ul style="list-style-type: none"> ● The phone number you dialed might have been edited incorrectly (for example, the long distance "1" or the area code is missing). Edit the phone number with another pattern (page 34).
Time on the unit has shifted.	<ul style="list-style-type: none"> ● Incorrect time information from incoming Caller ID changes the time. Set the time adjustment to "Manual" (off) (page 23).
The 2nd caller's information is not displayed during an outside call.	<ul style="list-style-type: none"> ● In order to use Caller ID, call waiting, or Call Waiting Caller ID (CWID), you must first contact your service provider/telephone company and subscribe to the desired service. After subscribing, you may need to contact your service provider/telephone company again to activate this specific service, even if you already subscribed to both Caller ID and Call Waiting with Caller ID services (CWID).

Answering system

Problem	Cause/solution
The unit does not record new messages.	<ul style="list-style-type: none">● The answering system is turned off. Turn it on (page 35).● The message memory is full. Erase unwanted messages (page 37).● The recording time is set to "Greeting only". Change the setting (page 40).● If you subscribe to a voice mail service, messages are recorded by your service provider/telephone company, not your telephone. Change the unit's number of rings setting or contact your service provider/telephone company (page 40).
I cannot operate the answering system remotely.	<ul style="list-style-type: none">● The remote access code is not set. Set the remote access code (page 38).● You are entering the wrong remote access code. If you have forgotten your remote access code, enter the remote access code setting to check your current code (page 38).● The answering system is turned off. Turn it on (page 39).
The unit does not emit the specified number of rings.	<ul style="list-style-type: none">● If the first ring is turned off, the number of rings decreases by 1 from the specified number of rings.

Liquid damage

Problem	Cause/solution
Liquid or other form of moisture has entered the handset/base unit.	<ul style="list-style-type: none">● Disconnect the AC adaptor and telephone line cord from the base unit. Remove the batteries from the handset and leave to dry for at least 3 days. After the handset/base unit are completely dry, reconnect the AC adaptor and telephone line cord. Insert the batteries and charge fully before use. If the unit does not work properly, contact an authorized service center.

Caution:

- To avoid permanent damage, do not use a microwave oven to speed up the drying process.

FCC and other information

This equipment complies with Part 68 of the FCC rules and the requirements adopted by the ACTA. On the bottom of this equipment is a label that contains, among other information, a product identifier in the format US:ACJ-----.

If requested, this number must be provided to the telephone company.

- Registration No.....(found on the bottom of the unit)
- Ringer Equivalence No. (REN).....0.1B

A plug and jack used to connect this equipment to the premises wiring and telephone network must comply with the applicable FCC Part 68 rules and requirements adopted by the ACTA. A compliant telephone cord and modular plug is provided with the product. It is designed to be connected to a compatible modular jack that is also compliant.

The REN is used to determine the number of devices that may be connected to a telephone line. Excessive RENs on a telephone line may result in the devices not ringing in response to an incoming call. In most but not all areas, the sum of RENs should not exceed five (5.0). To be certain of the number of devices that may be connected to a line, as determined by the total RENs, contact the local telephone company. For products approved after July 23, 2001, the REN for the product is part of the product identifier that has the format US:AAEQ##TXXXX. The digits represented by ## are the REN without a decimal point (e.g., 03 is a REN of 0.3).

If this equipment causes harm to the telephone network, the telephone company will notify you in advance that temporary discontinuance of service may be required. But if advance notice isn't practical, the telephone company will notify the customer as soon as possible. Also, you will be

advised of your right to file a complaint with the FCC if you believe it is necessary.

The telephone company may make changes in its facilities, equipment, operations or procedures that could affect the operation of the equipment. If this happens the telephone company will provide advance notice in order for you to make necessary modifications to maintain uninterrupted service.

If trouble is experienced with this equipment, for repair or warranty information, please contact a Factory Service Center or other Authorized Servicer. If the equipment is causing harm to the telephone network, the telephone company may request that you disconnect the equipment until the problem is resolved.

Connection to party line service is subject to state tariffs. Contact the state public utility commission, public service commission or corporation commission for information.

If your home has specially wired alarm equipment connected to the telephone line, ensure the installation of this equipment does not disable your alarm equipment. If you have questions about what will disable alarm equipment, consult your telephone company or a qualified installer.

This equipment is hearing aid compatible as defined by the FCC in 47 CFR Section 68.316.

When you hold the phone to your ear, noise might be heard in your Hearing Aid. Some Hearing Aids are not adequately shielded from external RF (radio frequency) energy. If noise occurs, use an optional headset accessory or the speakerphone option (if applicable) when using this phone. Consult with your audiologist or Hearing Aid

Useful Information

manufacturer about the availability of Hearing Aids which provide adequate shielding to RF energy commonly emitted by digital devices.

WHEN PROGRAMMING EMERGENCY NUMBERS AND/OR MAKING TEST CALLS TO EMERGENCY NUMBERS:

- 1) Remain on the line and briefly explain to the dispatcher the reason for the call.
- 2) Perform such activities in the off-peak hours, such as early morning or late evenings.

This device complies with Part 15 of the FCC Rules. Operation is subject to the following two conditions:

(1) This device may not cause harmful interference, and (2) this device must accept any interference received, including interference that may cause undesired operation.

Privacy of communications may not be ensured when using this phone.

CAUTION:

Any changes or modifications not expressly approved by the party responsible for compliance could void the user's authority to operate this device.

NOTE:

This equipment has been tested and found to comply with the limits for a Class B digital device, pursuant to Part 15 of the FCC Rules. These limits are designed to provide reasonable protection against harmful interference in a residential installation. This equipment generates, uses, and can radiate radio frequency energy and, if not installed and used in accordance with the instructions, may cause harmful interference to radio communications. However, there is no guarantee that interference will not occur in a particular installation. If this equipment does cause harmful interference to radio or television reception, which can be determined by turning the equipment off and on, the user is

encouraged to try to correct the interference by one or more of the following measures:

- Reorient or relocate the receiving antenna.
- Increase the separation between the equipment and receiver.
- Connect the equipment into an outlet on a circuit different from that to which the receiver is connected.
- Consult the dealer or an experienced radio/TV technician for help.

Some cordless telephones operate at frequencies that may cause interference to nearby TVs and VCRs. To minimize or prevent such interference, the base of the cordless telephone should not be placed near or on top of a TV or VCR. If interference is experienced, move the cordless telephone further away from the TV or VCR. This will often reduce or eliminate interference.

FCC RF Exposure Warning:

- This product complies with FCC radiation exposure limits set forth for an uncontrolled environment.
- To comply with FCC RF exposure requirements, the base unit must be installed and operated 20 cm (8 inches) or more between the product and all person's body.
- This product may not be collocated or operated in conjunction with any other antenna or transmitter.
- For body-worn operation, the handset must be used only with a non-metallic accessory. Use of other accessories may not ensure compliance with FCC RF exposure requirements.

Notice:

- FCC ID can be found inside the battery compartment or on the bottom of the units.

Guía Rápida Española

Conexiones

Unidad base

- ① Conecte el adaptador de corriente alterna a la unidad hasta que escuche un clic.
- ② Enganche el cable para fijarlo.
- ③ Conecte el adaptador de corriente alterna a la toma de corriente.
- ④ Conecte el cable de la línea telefónica a la unidad hasta que escuche un clic.
- ⑤ Enganche el cable para fijarlo.
- ⑥ Conecte el cable de la línea telefónica a la toma de una sola línea telefónica (RJ11C) hasta que escuche un clic.
- ⑦ Se requiere un filtro DSL/ADSL (no incluido) si tiene este tipo de servicio.

Nota:

- Use solo el adaptador de corriente alterna Panasonic PNLV226 que se suministra.

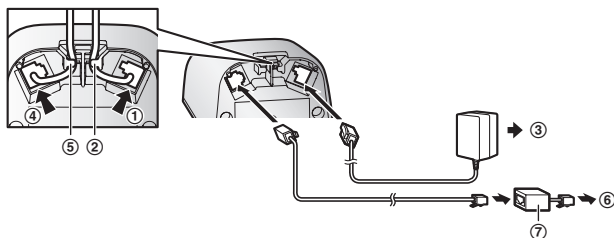

Instalación y carga de la batería

Cargue aproximadamente durante 7 horas.

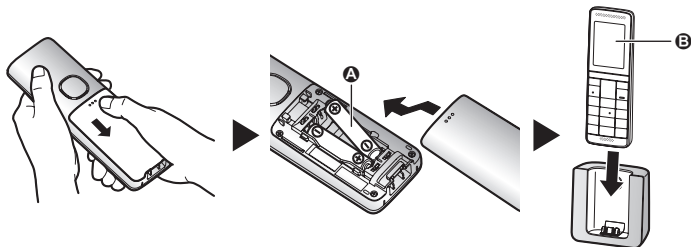

Nota:

- UTILICE SOLO baterías recargables de Ni-MH tamaño AAA (R03) (A).
- NO utilice baterías Alcalinas, de Manganeseo o de Ni-Cd.
- Confirme que las polaridades estén correctas (+, -).
- Cambie el idioma de la pantalla (página 50).
- Confirme que aparezca "Cargando" (B).

Sugerencias de operación

Teclas de función

Al oprimir una tecla de función, puede seleccionar la función que aparece directamente encima de ella en la pantalla. Preste atención a la pantalla para ver qué funciones están asignadas a las teclas de función durante la operación.

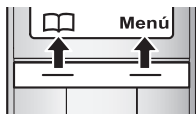

Tecla navegadora

- [▲], [▼], [◀] o [▶]: Navegue por diversas listas y elementos.
- ▲ (Volumen: [▲] o [▼]): Ajuste el volumen del receptor o el altavoz mientras habla.
- [▼] CID (identificador de llamadas): Vea la lista de personas que llaman.
- [◀] □□: Vea la entrada del directorio telefónico.
- [▶] REDIAL (Remarcación): Vea la lista de remarcación.

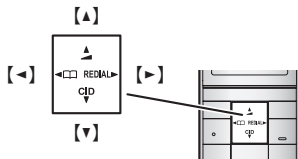

Cambio de idiomas (Auricular) (predeterminado: "English")

Cuando instale las baterías por primera vez, es posible que aparezca "Date and time Press [Select]". Oprima [OFF] para salir.

Idioma de la pantalla

[Menú] (tecla de función de la derecha) #1110 → [↕]: "Español" → [Guardar] → [OFF]

Idioma de la guía de voz

[Menú] (tecla de función de la derecha) #1112 → [↕]: "Español" → [Guardar] → [OFF]

Fecha y hora (Auricular)

- 1 [Menú] (tecla de función de la derecha) #101
- 2 Introduzca el día, mes y año actuales. → [OK]
- 3 Introduzca la hora y minuto actuales.
- 4 [Guardar] → [OFF]

Operaciones básicas	
Cómo hacer y contestar llamadas (Auricular)	
Para hacer llamadas	Marque el número telefónico. → [📞]/[📞]
Para contestar llamadas	[📞]/[📞]
Para colgar	[OFF]
Para ajustar el volumen del receptor o del altavoz	Oprima [▲] o [▼] repetidamente mientras habla.
Cómo hacer una llamada usando la lista de remarcación	[▶] REDIAL → [⬆] : Seleccione el número telefónico deseado. → [📞]
Volumen del timbre del auricular	Oprima [▲] o [▼] repetidamente para seleccionar el volumen deseado mientras timbra.
Directorio telefónico (Auricular)	
Cómo agregar entradas al directorio telefónico	<ol style="list-style-type: none"> [□] o [◀] □ → [Menú] [⬆]: "Agregar Ent. Nueva" → [Selec.] [⬆]: "(Nombre)" → [Selec.] Introduzca el nombre de la persona (máx. 16 caracteres). → [OK] [⬆]: "(Núm Teléfono 1)" → [Selec.] <ul style="list-style-type: none"> Puede almacenar hasta 3 números telefónicos por cada entrada. Introduzca el número telefónico de la persona (máx. 24 dígitos). → [OK] [⬆]: "Grupo 1" → [Selec.] [⬆]: Seleccione el grupo deseado. → [Selec.] [Guardar] → [OFF]
Para hacer llamadas	<ol style="list-style-type: none"> [□] o [◀] □ [⬆]: Seleccione la entrada deseada. → [📞] [⬆]: Seleccione el número telefónico deseado. → [📞]
Sistema contestador de llamadas (Auricular)	
Para escuchar mensajes	<p>Para escuchar mensajes nuevos: [Reproducir] o [Menú] (tecla de función de la derecha) # [3] [2] [3]</p> <p>Para escuchar todos los mensajes: [Menú] (tecla de función de la derecha) # [3] [2] [4]</p>

Preguntas frecuentes	
Pregunta	Causa y solución
¿Por qué aparece  ?	<ul style="list-style-type: none"> ● El auricular está demasiado lejos de la unidad base. Acérquelo. ● El adaptador para corriente de la unidad base no está conectado correctamente. Conecte de nuevo el adaptador para corriente a la unidad base. ● El auricular no está registrado en la unidad base. Regístrelo. <ol style="list-style-type: none"> Auricular: [Menú] (tecla de función de la derecha) # 1 3 0 Unidad base: Oprima y mantenga oprimido [••] durante aproximadamente 5 segundos. Auricular: Oprima [OK], y después espere hasta que suene un pitido largo.
¿Cómo se incrementa el nivel de volumen del auricular?	<ul style="list-style-type: none"> ● Oprima la tecla de navegación [▲] repetidamente mientras habla.
¿Por qué hay ruido o se corta la conversación?	<ul style="list-style-type: none"> ● Trate de reubicar la unidad base de forma que se minimice la distancia al auricular. ● Si ocurre el mismo problema aunque el auricular se encuentre enseguida de la unidad base, visite: http://www.panasonic.com/support
¿Es posible añadir otro auricular accesorio a mi unidad base?	<ul style="list-style-type: none"> ● Sí, puede añadir hasta 6 auriculares (incluyendo los que se venden con su unidad base) a una sola unidad base. ● Para adquirir auriculares accesorios adicionales (KX-PRSA10), visite: http://www.pstc.panasonic.com Los usuarios TTY (usuarios con impedimentos auditivos o del habla) pueden llamar al 1-866-605-1277.
¿Es posible mantener cargando las baterías todo el tiempo?	<ul style="list-style-type: none"> ● Puede dejar el auricular en la unidad base o el cargador en cualquier momento. Esto no daña las baterías.
¿Cómo se contestan las llamadas en espera (segunda llamada)?	<ul style="list-style-type: none"> ● Oprima [CALL WAIT] cuando escuche el tono de llamada en espera.

Customer services

Customer Services Directory (United States and Puerto Rico)

Obtain Product Information and Operating Assistance; locate your nearest Dealer or Service Center; purchase Parts and Accessories; or make Customer Service and Literature requests by visiting our Web Site at:

<http://www.panasonic.com/help>

or, contact us via the web at:

<http://www.panasonic.com/contactinfo>

For hearing or speech impaired TTY users, TTY: 1-877-833-8855

Accessory Purchases (United States and Puerto Rico)

Purchase Parts, Accessories and Owner's Manual online for all Panasonic Products by visiting our Web Site at:

<http://www.pstc.panasonic.com>

or, send your request by E-mail to:

npcparts@us.panasonic.com

You may also contact us directly at:

1-800-237-9080 (Fax Only)

(Monday - Friday 9 am to 9 pm, EST.)

Panasonic National Parts Center

20421 84th Avenue S., Kent, WA 98032

(We accept Visa, MasterCard, Discover Card, American Express.)

For hearing or speech impaired TTY users, TTY: 1-866-605-1277

Warranty (For United States and Puerto Rico)

Panasonic Telephone Products Limited Warranty

Limited Warranty Coverage

If your product does not work properly because of a defect in materials or workmanship, Panasonic Corporation of North America (referred to as "the warrantor") will, for the length of the period indicated on the chart below, which starts with the date of original purchase ("Limited Warranty period"), at its option either (a) repair your product with new or refurbished parts, or (b) replace it with a new or a refurbished equivalent value product, or (c) refund your purchase price. The decision to repair, replace or refund will be made by the warrantor.

Parts	Labor
One (1) Year	One (1) Year

During the "Labor" Limited Warranty period there will be no charge for labor. During the "Parts" Limited Warranty period, there will be no charge for parts. You must mail-in your product prepaid during the Limited Warranty period. This Limited Warranty excludes both parts and labor for batteries, antennas, and cosmetic parts (cabinet). This Limited Warranty only applies to products purchased and serviced in the United States or Puerto Rico. This Limited Warranty is extended only to the original purchaser and only covers products purchased as new.

Mail-In Service--Online

Online Repair Request

To submit a new repair request and for quick repair status visit our Web Site at <http://www.panasonic.com/repair>

When shipping the unit carefully pack in a padded shipping carton, include all accessories, and send it prepaid. Include a letter detailing the complaint, a return address and provide a day time phone number where you can be reached. P.O. Boxes are not acceptable. Keep the tracking number for your records. A copy of valid registered receipt is required under the 1 year parts and labor Limited Warranty.

For Limited Warranty service for headsets if a headset is included with this product please follow instructions above.

IF REPAIR IS NEEDED DURING THE LIMITED WARRANTY PERIOD THE PURCHASER WILL BE REQUIRED TO FURNISH A SALES RECEIPT/PROOF OF PURCHASE INDICATING DATE OF PURCHASE, AMOUNT PAID AND PLACE OF PURCHASE. CUSTOMER WILL BE CHARGED FOR THE REPAIR OF ANY UNIT RECEIVED WITHOUT SUCH PROOF OF PURCHASE.

Limited Warranty Limits And Exclusions

This Limited Warranty ONLY COVERS failures due to defects in materials or workmanship, and DOES NOT COVER normal wear and tear or cosmetic damage. The Limited Warranty ALSO DOES NOT COVER damages which occurred in shipment, or failures which are caused by products not supplied by the warrantor, or failures which result from accidents, misuse, abuse, neglect, bug infestation, mishandling, misapplication, alteration, faulty installation, set-up adjustments, misadjustment of consumer controls, improper maintenance, power line surge, lightning damage, modification, introduction of sand, humidity or liquids, commercial use such as hotel, office, restaurant, or other business or rental use of the product, or service by anyone other than a Factory Service Center or other Authorized Servicer, or damage that is attributable to acts of God.

THERE ARE NO EXPRESS WARRANTIES EXCEPT AS LISTED UNDER "LIMITED WARRANTY COVERAGE". THE WARRANTOR IS NOT LIABLE FOR INCIDENTAL OR CONSEQUENTIAL DAMAGES RESULTING FROM THE USE OF THIS PRODUCT, OR ARISING OUT OF ANY BREACH OF THIS LIMITED WARRANTY. (As examples, this excludes damages for lost time, lost calls or messages, cost of having someone remove or re-install an installed unit if applicable, travel to and from the servicer. The items listed are not exclusive, but are for illustration only.) **ALL EXPRESS AND IMPLIED WARRANTIES, INCLUDING THE WARRANTY OF MERCHANTABILITY, ARE LIMITED TO THE PERIOD OF THE LIMITED WARRANTY.**

Some states do not allow the exclusion or limitation of incidental or consequential damages, or limitations on how long an implied warranty lasts, so the exclusions may not apply to you.

This Limited Warranty gives you specific legal rights and you may also have other rights which vary from state to state. If a problem with this product develops during or after the Limited Warranty period, you may contact your dealer or Service Center. If the problem is not handled to your satisfaction, then write to the warrantor's Consumer Affairs Department at the addresses listed for the warrantor.

PARTS AND SERVICE, WHICH ARE NOT COVERED BY THIS LIMITED WARRANTY, ARE YOUR RESPONSIBILITY.

When you ship the product

- Carefully pack your unit, preferably in the original carton.
- Attach a letter, detailing the symptom.
- Send the unit to Panasonic Exchange Center, prepaid and adequately insured.
- Do not send your unit to Panasonic Corporation of North America listed on the back cover or to executive or regional sales offices. These locations do not repair consumer products.

Index

- # 3-way conference: 15
- A Additional handsets: 32
 - Alarm: 27
 - Answering calls: 14
 - Answering system: 35
 - Call screening: 40
 - Erasing messages: 36, 37, 39
 - Greeting message: 35
 - Greeting only: 40
 - Listening to messages: 36, 39
 - Message list: 36
 - New message alerting: 37
 - Number of rings: 40
 - Recording time: 40
 - Remote access code: 38
 - Remote operation: 38
 - Ring count: 40
 - Toll saver: 40
 - Turning on/off: 35
 - Auto intercom: 16
 - Auto talk: 14, 24
- B Baby monitor: 29
 - Battery: 9, 10
 - Booster (Clarity booster): 15
- C Calendar: 31
 - Call block: 28
 - First ring: 29
 - Call share: 15, 25
 - Call waiting: 15
 - Call Waiting Caller ID: 15
 - Caller ID number auto edit: 24, 34
 - Caller ID service: 33
 - Caller list: 33
 - Caller list edit: 34
 - Chain dial: 19
 - CID (Caller ID): 33
 - Conference calls: 16
 - Control type: 11
 - Customer support: 25
- D Date and time: 12
 - Dialing mode: 13
 - Direct command code: 21
 - Display
 - Clock: 24
 - Color: 24
 - Contrast: 24
 - Display mode: 24
 - Language: 12
 - LCD backlight: 24
 - Wallpaper: 24
- E Eco mode: 10
 - Equalizer: 15
 - Error messages: 42
- F Flash: 15, 25
- G Groups: 18
- H Handset
 - Deregistration: 32
 - Name: 31
 - Registration: 32
 - Hold: 14
- I Intercom: 16
- K Key detector: 23, 25
 - Key tone: 24
- L Line mode: 25
- M Making calls: 14
 - Missed calls: 33
 - Mute: 14
- N Noise reduction: 15
- P Pause: 14
 - Phonebook: 17
 - Power failure: 10
- R Redialing: 14
 - Ringer tone: 23
 - Rotary/pulse service: 15
- S Schedule: 31
 - Silent mode: 27
 - Speed dial: 19
 - SP-PHONE (Speakerphone): 14
- T Talking Caller ID: 23, 33
 - Temporary tone dialing: 15
 - Time adjustment: 23
 - Transferring calls: 16
 - Troubleshooting: 43
 - TTY: 53
- V VM (Voice mail): 41
 - Voice guidance language: 12
 - Voice mail: 40, 41
 - Volume
 - Receiver: 14
 - Ringer (Handset): 14, 23
 - Speaker: 14

IMPORTANT!

If your product is not working properly. . .

- ① **Reconnect AC adaptor to the base unit.**
- ② **Check if telephone line cord is connected.**
- ③ **Use rechargeable Ni-MH batteries.**
(Alkaline/Manganese/Ni-Cd batteries CANNOT be used.)
- ④ Read **troubleshooting** page in the **Operating Instructions**.



Visit our Web site: <http://www.panasonic.com/help>

- **FAQ and troubleshooting hints are available.**

For your future reference

We recommend keeping a record of the following information to assist with any repair under warranty.

Serial No.	Date of purchase
(found on the bottom of the base unit)	
Name and address of dealer	

Attach your purchase receipt here.

Panasonic Corporation of North America

Two Riverfront Plaza, Newark, NJ 07102-5490

© Panasonic System Networks Co., Ltd. 2013

Printed in China



PNQX6043YA

PNQX6043YA TT0913MU1014 (E)