



Panasonic®

Operating Instructions

Compact Plain Paper Fax with DECT

Model No. **KX-FC265E**
KX-FC275E

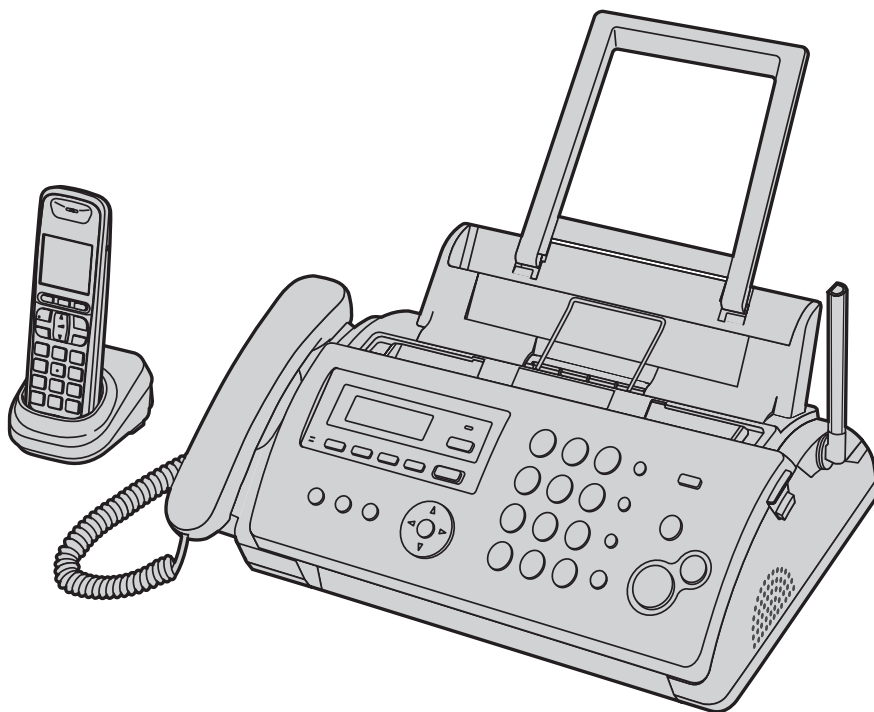

KX-FC275

Please read these operating instructions before using the unit and save for future reference.

Charge the battery for about 7 hours before initial use.

- This unit is compatible with Caller ID. Subscription to the appropriate service through your service provider/telephone company is required.

Thank you for purchasing a Panasonic fax machine.

Things you should keep a record of

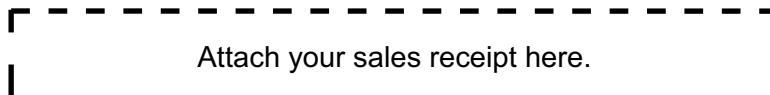

For your future reference

Date of purchase
Serial number (found on the rear of the unit)
Retailer's/Dealer's name and address
Retailer's/Dealer's telephone number

Note:

- The suffix in the model number will be omitted in these instructions.

Caution:

- Note that the images of copied or received documents will remain on the used ink film. Use discretion when disposing of the used ink film.
- Do not rub or use an eraser on the printed side of the recording paper, as the print may smear.
- In the event of problems, you should contact your equipment supplier in the first instance.
- This equipment is designed for use on the UK and Republic of Ireland analogue telephone network.

Declaration of Conformity:

- Panasonic System Networks Co., Ltd. declares that this equipment is in compliance with the essential requirements and other relevant provisions of Radio & Telecommunications Terminal Equipment (R&TTE) Directive 1999/5/EC.
Declarations of Conformity for the relevant Panasonic products described in this manual are available for download by visiting:
<http://www.doc.panasonic.de>

Contact to Authorised Representative:
Panasonic Testing Centre
Panasonic Marketing Europe GmbH
Winsbergring 15, 22525 Hamburg, Germany

Notice for product disposal, transfer, or return:

- This product can store your private/confidential information. To protect your privacy/confidentiality, we recommend that you erase the information such as phonebook (or caller information) from the memory before you dispose of, transfer or return the product.

Environment:

- Panasonic's strategic direction incorporates concern for the environment into all aspects of the product life cycle, from product development to energy saving designs; from greater product reusability to waste-conscious packaging practices.

ENERGY STAR:

- As an ENERGY STAR® Partner, Panasonic has determined that this product meets the ENERGY STAR guidelines for energy efficiency. ENERGY STAR is a U.S. registered mark.



For your safety

To prevent severe injury and loss of life/property, read this section carefully before using the unit to ensure proper and safe operation of your unit.

WARNING

Power and ground connection

- Unplug this unit from power outlets if it emits smoke, an abnormal smell or makes unusual noise. These conditions can cause fire or electric shock. Confirm that smoke has stopped and contact an authorised service centre.
- Use only the power source marked on the unit. If you are not sure of the type of power supplied to your home, consult your retailer/dealer or local power company.
- For safety purposes this unit is equipped with a grounded plug. If you do not have this type of outlet, please have one installed. Do not ignore this safety feature by tampering with the plug.
- Do not place objects on the mains lead. Install the unit where no one can step or trip on the cord.
- Do not overload power outlets and extension cords. This can result in the risk of fire or electric shock.
- Completely insert the AC adaptor/power plug into the power outlet. Failure to do so may cause electric shock and/or excessive heat resulting in a fire.
- Regularly remove any dust, etc. from the AC adaptor/power plug by pulling it from the power outlet, then wiping with a dry cloth. Accumulated dust may cause an insulation defect from moisture, etc. resulting in a fire.
- Unplug from power outlets and never touch the inside of the product if its casing has been broken open.
- Never touch the plug with wet hands. There is a danger of electric shock.

Installation

- Place the unit securely on a stable, level surface. Serious damage and/or injury may result if the unit falls.
- To prevent the risk of fire or electrical shock, do not expose this product to rain or any type of moisture.
- Use this unit in a well ventilated area. Particularly, if you will be using the unit for extended periods of time or will be printing in large volumes, be sure to ventilate the room sufficiently.
- Do not place or use this product near automatically controlled devices such as automatic doors and fire alarms. Radio waves emitted from this product may cause such devices to malfunction resulting in an accident.
- Do not allow the AC adaptor or telephone line cord to be excessively pulled, bent or placed under heavy objects.

Operating safeguards

- Unplug this unit from power outlets before cleaning. Do not use liquid or aerosol cleaners.
- Do not cover slots and openings on the unit. They are provided for ventilation and protection against overheating. Never place the unit near radiators, or in a place where proper ventilation is not provided.
- Never push any objects through slots in this unit. This may result in the risk of fire or electric shock. Never spill any liquid on the unit.
- To reduce the risk of electric shock, do not disassemble this unit. Take the unit to an authorised service centre when service is required. Opening or removing covers may expose you to dangerous voltage or other risks. Incorrect reassembly can cause electric shock when the unit is subsequently used.
- Follow all warnings and instructions marked on this unit.
- Do not disassemble the product.
- Do not spill liquids (detergents, cleansers, etc.) onto the telephone line cord plug, or allow it to become wet at all. This may cause a fire. If the telephone line cord plug becomes wet, immediately pull it from the telephone wall jack, and do not use.
- Unplug this unit from power outlets and refer servicing to an authorised service centre when any of the following conditions occur:
 - If the mains lead is damaged or frayed.
 - If the unit has been exposed to rain or water, or liquid has been spilled into the unit. Do not use a microwave oven to speed up the drying process of any parts of the unit (including the cordless handset) to avoid permanent damage.
 - If the unit does not work normally by following the operating instructions. Adjust only controls covered by the operating instructions. Improper adjustment may require extensive work by an authorised service centre.
 - If the unit has been dropped or physically damaged.
 - If the unit exhibits a distinct change in performance.

Medical

- Consult the manufacturer of any personal medical devices, such as pacemakers or hearing aids, to determine if they are adequately shielded from external RF (radio frequency) energy. (The product operates in the frequency range of 1.88 GHz to 1.90 GHz, and the RF transmission power is 250 mW (max.).)
- Do not use the product in health care facilities if any regulations posted in the area instruct you not to do so. Hospitals or health care facilities may be using equipment that could be sensitive to external RF energy.

CAUTION**Installation and relocation**

- After moving the unit from cold areas to warmer areas, wait approximately 30 minutes before connecting the unit to allow the unit to adjust to the ambient temperature. If the unit is connected too soon after a sudden climate change, condensation may form inside the unit, causing malfunction.
- Never turn the unit upside down or sideways when moving it.
- Never install telephone wiring during a lightning storm.
- Never install telephone jacks in wet locations unless the jack is specifically designed for wet locations.
- Never touch uninsulated telephone wires or terminals unless the telephone line has been disconnected at the network interface.
- Use caution when installing or modifying telephone lines.
- The AC adaptor is used as the main disconnect device. Ensure that the AC outlet is installed near the unit and is easily accessible.
- This unit is unable to make calls when:
 - the cordless handset batteries need recharging or have failed.
 - there is a power failure.
 - the key lock feature is turned ON.
- Do not position the unit in a location where it is unstable or subject to vibrations.

LED light**CLASS 1 LED PRODUCT**

- When using the unit, do not look directly at the CIS's LED light. Direct eye exposure can cause eye damage.

CIS's LED light properties

LED radiation output : Max. 1 mW
 Wavelength : Yellowish Green 570 nm typical
 Emission duration : Continuous

Battery

- Do not mix old and new batteries.
- Do not open or mutilate the battery(ies). Released electrolyte from the battery(ies) is corrosive and may cause burns or injury to the eyes or skin. The electrolyte is toxic and may be harmful if swallowed.
- Exercise care when handling the battery(ies). Do not allow conductive materials such as rings, bracelets or keys to touch the battery(ies), otherwise a short circuit may cause the battery(ies) and/or the conductive material to overheat and cause burns.
- Charge the battery(ies) provided with or identified for use with this product only in accordance with the

instructions and limitations specified in these operating instructions.

- Only use the compatible charger to charge the battery(ies). Do not tamper with the charger. Failure to follow these instructions may cause the battery(ies) to swell or explode.

Important safety instructions

When using this unit, basic safety precautions should always be followed to reduce the risk of fire, electric shock, or personal injury.

1. Do not use this unit near water, for example near a bathtub, wash bowl, kitchen sink, etc.
2. During thunderstorms, avoid using telephones except cordless types. There may be a remote risk of an electric shock from lightning.
3. Do not use the telephone of this unit (if so equipped) to report a gas leak, when in the vicinity of the leak.
4. Use only the mains lead and batteries indicated in these operating instructions.
5. Do not dispose of the battery(ies) in a fire. They may explode. Check with local codes for possible special disposal instructions.

SAVE THESE INSTRUCTIONS**For best performance****Location**

- To avoid malfunction, do not position the unit near appliances such as TVs or speakers which generate an intense magnetic field.

Static electricity

- To prevent static electricity damage to the interface connectors or other electrical components inside the unit, touch a grounded metal surface before touching the components.

Location and noise

The base unit and other compatible Panasonic units use radio waves to communicate with each other.

- For maximum coverage and noise-free communications, place your base unit:
 - at a convenient, high, and central location with no obstructions between the cordless handset and base unit in an indoor environment.
 - away from electronic appliances such as TVs, radios, personal computers, wireless devices, or other phones.
 - facing away from radio frequency transmitters, such as external antennas of mobile phone cell stations. (Avoid putting the base unit on a bay window or near a window.)

Important Information

- Coverage and voice quality depends on the local environmental conditions.
- If the reception for a base unit location is not satisfactory, move the base unit to another location for better reception.

Environment

- Keep the unit away from electrical noise generating devices, such as fluorescent lamps and motors.
- The unit should be kept free from dust, high temperature and vibration.
- The unit should not be exposed to direct sunlight.
- Do not place heavy objects on top of the unit.
- When you leave the unit unused for a long period of time, unplug this unit from the power outlet.
- The unit should be kept away from heat sources such as heaters, kitchen stoves, etc. It should not be placed in rooms where the temperature is less than 5 °C (base unit)/0 °C (cordless handset, charger unit) or greater than 35 °C (base unit)/40 °C (cordless handset, charger unit). Damp basements should also be avoided.
- The maximum calling distance may be shortened when the unit is used in the following places: Near obstacles such as hills, tunnels, underground, near metal objects such as wire fences, etc.

Routine care

- Wipe the outer surface of the unit with a soft cloth. Do not use benzine, thinner, or any abrasive powder.

Information for Users on Collection and Disposal of Old Equipment and used Batteries

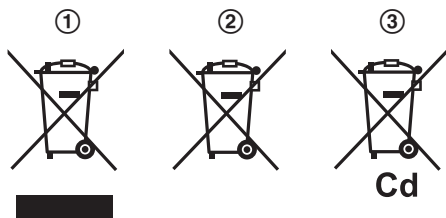

These symbols (①, ②, ③) on the products, packaging, and/or accompanying documents mean that used electrical and electronic products and batteries should not be mixed with general household waste.

For proper treatment, recovery and recycling of old products and used batteries, please take them to applicable collection points, in accordance with your national legislation and the Directives 2002/96/EC and 2006/66/EC.

By disposing of these products and batteries correctly, you will help to save valuable resources and prevent any potential negative effects on human health and the environment which could otherwise arise from inappropriate waste handling.

For more information about collection and recycling of old products and batteries, please contact your local municipality, your waste disposal service or the point of sale where you purchased the items.

Penalties may be applicable for incorrect disposal of this waste, in accordance with national legislation.

For business users in the European Union

If you wish to discard electrical and electronic equipment, please contact your dealer or supplier for further information.

Information on Disposal in other Countries outside the European Union

These symbols (①, ②, ③) are only valid in the European Union. If you wish to discard these items, please contact your local authorities or dealer and ask for the correct method of disposal.

Note for the battery symbol

This symbol (②) might be used in combination with a chemical symbol (③). In this case it complies with the requirement set by the Directive for the chemical involved.

Illegal copies

- **It is unlawful to make copies of certain documents.**

Copying certain documents may be illegal in your country. Penalties of fines and/or imprisonment may be imposed on those found guilty. The following are examples of items that may be illegal to copy in your country.

- Currency
- Bank notes and cheques
- Bank and government bonds and securities
- Passports and identification cards
- Copyright material or trademarks without the consent of the owner
- Postage stamps and other negotiable instruments

This list is not inclusive and no liability is assumed for either its completeness or accuracy. In case of doubt, contact your legal counsel.

Notice:

- Install your machine near a supervised area to prevent illegal copies from being made.

Important Information

The connection to the telecommunication systems must not be hard wired and must be unplugged before the earth is disconnected.

Method of connection

This apparatus is connected to the exchange line or PABX/PMBX extension by the new standard British Telecom plug and socket. Arrangements for provision of this type of termination can be made through the nearest British Telecom Sales Office.

This apparatus may be connected to the following types of installation.

- a) For connection to the public switched telephone network (PSTN) and compatible PBX (Private Branch Exchange), which use DTMF signalling. (Please consult your supplier for an up to date list of compatible PBX's.)
- b) The apparatus can be used on extension sockets connected to a direct exchange line (D.E.L.).
- c) This apparatus is suitable for connection to the telecommunication system directly or via compatible private branch exchange as an extension. The supplier of the apparatus should be consulted for an up to date list of PBX's with which the apparatus is compatible.

It cannot be guaranteed that the apparatus will operate under all possible conditions of connection to compatible PBX's.

- This apparatus is suitable for connection to a PBX with or without initial proceed indication.
- This apparatus is suitable for connection to a PBX with or without secondary proceed indication.

Any cases of difficulty should be referred in the first instance to the supplier of the apparatus.

- d) The apparatus must not be connected in the following manner:
 - As an extension to a pay phone
 - As a party line with shared service

NOTES:

- If you experience any problems with the normal use of your apparatus, you should unplug it from the telephone outlet and connect a known working telephone in its place. If the known working telephone still gives problems, then please contact the customer service department of your PSTN operator (e.g. BT etc.). If it operates properly, then the problems are likely to be a fault in your apparatus. In this case, consult your supplier for advice.
- Your PSTN operator may charge you if they attend a service call that is not due to apparatus supplied by them.

For your safety

This appliance is supplied with a moulded three pin mains plug for your safety and convenience.

Should the fuse need to be replaced please ensure that the replacement fuse is of the same rating and that it is approved by ASTA or BSI to BS1362.

Check for ASTA mark  or the BSI

mark  on the body of the fuse.

If the plug contains a removable fuse cover you must ensure that it is refitted when the fuse is replaced.

If you lose the fuse cover the plug must not be used until a replacement cover is obtained.

A replacement fuse cover can be purchased from your local Panasonic dealer.

IF THE FITTED MOULDED PLUG IS UNSUITABLE FOR THE SOCKET OUTLET IN YOUR HOME THEN THE FUSE SHOULD BE REMOVED AND THE PLUG CUT OFF AND DISPOSED OF SAFELY. THERE IS A DANGER OF SEVERE ELECTRICAL SHOCK IF THE CUT OFF PLUG IS INSERTED INTO ANY 13 AMP SOCKET.

If a new plug is to be fitted please observe the wiring code as shown below.

If in any doubt please consult a qualified electrician.

WARNING: THIS APPLIANCE MUST BE EARTHED.

IMPORTANT:

The wires in this mains lead are coloured in accordance with the following code:

Green-and-Yellow:	Earth
Blue:	Neutral
Brown:	Live

As the colours of the wire in the mains lead of this appliance may not correspond with the coloured markings identifying the terminals in your plug, proceed as follows.

The wire which is coloured GREEN-AND-YELLOW must be connected to the terminal in the plug which is marked with the letter E or by the Earth symbol \perp or coloured GREEN or GREEN-AND-YELLOW.

The wire which is coloured BLUE must be connected to the terminal in the plug which is marked with the letter N or coloured BLACK.

The wire which is coloured BROWN must be connected to the terminal in the plug which is marked with letter L or coloured RED.

How to replace the fuse: Open the fuse compartment with a screwdriver and replace the fuse (and fuse cover).

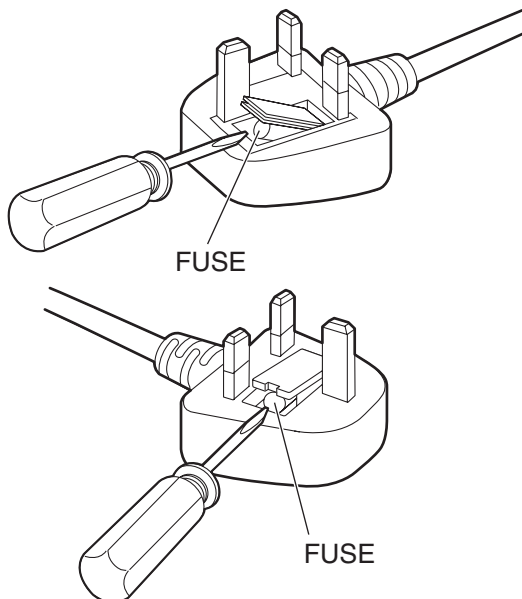

1. Introduction and Installation

Accessories

- 1.1 Supplied accessories11
- 1.2 Accessory information11

Finding the Controls

- 1.3 Button descriptions of the base unit12
- 1.4 Button descriptions of the cordless handset13
- 1.5 Display descriptions of the cordless handset13
- 1.6 Overview14

Installation

- 1.7 Ink film15
- 1.8 Paper tray17
- 1.9 Recording paper17
- 1.10 Handset cord (KX-FC275 only)18
- 1.11 Battery installation / replacement18

2. Preparation

Connections and Setup

- 2.1 Connections20
- 2.2 Battery charge21
- 2.3 Turning the cordless handset power ON/OFF21

Volume

- 2.4 Adjusting cordless handset volume21
- 2.5 Adjusting base unit volume22

Initial Programming

- 2.6 Date and time22
- 2.7 Your logo22
- 2.8 Your fax number23

3. Telephone

Making and Answering Calls

- 3.1 Making phone calls24
- 3.2 Answering phone calls24

Automatic Dialling

- 3.3 Cordless handset phonebook25
- 3.4 Chain dial (Cordless handset only)25
- 3.5 Base unit phonebook26
- 3.6 One touch dial (Base unit only)26

Caller Identification

- 3.7 Caller ID service27
- 3.8 Viewing and calling back27
- 3.9 Editing a caller's telephone number before calling back28
- 3.10 Erasing caller information28
- 3.11 Storing caller information into the phonebook29

4. Fax

Sending Faxes

- 4.1 Sending a fax manually30
- 4.2 Document requirements30
- 4.3 Sending a fax using the phonebook and one touch dial31
- 4.4 Broadcast transmission31

Receiving Faxes

- 4.5 Selecting the way to use your fax machine32
- 4.6 Receiving a fax manually – Auto answer OFF33
- 4.7 Receiving a fax automatically – Auto answer ON34
- 4.8 Receive polling (retrieving a fax placed on another fax machine)35
- 4.9 Junk fax prohibitor (preventing fax reception from undesired callers)35

5. Copy

Copying

- 5.1 Making a copy37

6. Answering Machine

Greeting

- 6.1 Recording your greeting message38

Incoming Messages

- 6.2 Listening to recorded messages38

Memo Message

- 6.3 Leaving a message for others or yourself39

Remote Operation

- 6.4 Using the answering machine with the cordless handset39
- 6.5 Operating from a remote location40

7. Programmable Features

Base Unit

- 7.1 Base unit programming42

Cordless Handset

- 7.2 Cordless handset programming47

8. Multi-unit Operation

Additional Units

- 8.1 Operating additional units50
- 8.2 Registering a cordless handset to a base unit50

Other Features

- 8.3 Intercom50
- 8.4 Transferring a call/conference51
- 8.5 Copying phonebook items52

9. Useful Information

Useful Information

- 9.1 Character entry53

10. Help

Reports and Displays

- 10.1 Report messages55
- 10.2 Display messages55

Troubleshooting

- 10.3 When a function does not work57

11. Maintenance

Jams

- 11.1 Recording paper jams64
- 11.2 Document jams65

Cleaning

- 11.3 Document feeder/recording paper feeder/
scanner glass cleaning65
- 11.4 Thermal head cleaning66

12. General Information

Printed Reports

- 12.1 Reference lists and reports (Base unit
only)68

Specifications

- 12.2 Specifications68

Guarantee

- 12.3 Condition of guarantee70

13. Index

- 13.1 Index.....71

1.1 Supplied accessories

- ① Telephone line cord
(PQJA87S)*2*3



- ② Handset*1
(PNLXN1005Z)*2



- ③ Handset cord*1
(PFJA04C003Z)*2

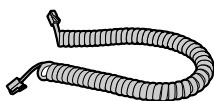

- ④ Paper tray
① Paper support
(PFKS1148Z2 or
PFKS1148Z3)*2

- ② Paper tray
(PFKS1145Z3 or
PFKS1145Z4)*2

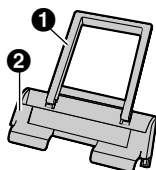

- ⑤ Starter ink film
(10 metres long)

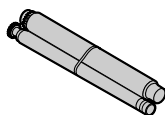

- ⑥ Cordless handset



- ⑦ Rechargeable
batteries
(HHR-55AAAB)*2



- ⑧ AC adaptor
(PQLV219E)*1*2



- ⑨ Charger*1
(PNLC1008YS)*2



- ⑩ Operating
instructions
(PNQX3064Z)*2



- ⑪ Quick installation
guide
(PNQW1872Y)*2

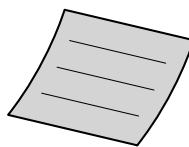

*1 KX-FC275 only

*2 Part numbers are subject to change without notice.

*3 For UK.

Note:

- Save the original carton and packing materials for future shipping and transportation of the unit.
- After unpacking the product, take care of the packing materials and/or power plug cap appropriately.

1.2 Accessory information

1.2.1 Sales and Support Information

Customer Care Centre

- For customers within the UK:
0844 844 3878 (for fax machine)
0844 844 3867 (for MFP)
- For customers within the Republic of Ireland:
01 6130082 (for fax machine)
01 2898255 (for MFP)
- Visit our website for product information
- E-mail: customer.care@panasonic.co.uk

Direct Sales at Panasonic UK

- Order accessory and consumable items for your product with ease and confidence by phoning our Customer Care Centre Monday - Thursday 9:00am - 5:30pm, Friday 9:30am - 5:30pm (Excluding public holidays).
- Or go on line through our Internet Accessory ordering application at www.panasonic.co.uk.
- Most major credit and debit cards accepted.
- All enquires transactions and distribution facilities are provided directly by Panasonic UK Ltd.
- It couldn't be simpler!
- Also available through our Internet is direct shopping for a wide range of finished products, take a browse on our website for further details.

Additional/replacement accessories

- **Replacement film*1**
Model No. (Part No.): KX-FA52X
30 m × 2 rolls (Each roll will print about 90 A4-sized pages.)
- **Rechargeable batteries*2**
Model No. (Part No.): P03P or HHR-4MRE

1. Introduction and Installation

2 rechargeable nickel metal hydride (Ni-MH) batteries, AAA (R03) size

– **Additional digital cordless handset**

Model No. (Part No.): KX-TGA641E

– **DECT repeater**

Model No. (Part No.): KX-A272

*1 To ensure the unit operates properly, we recommend using the Panasonic replacement film. **The ink film is not reusable. Do not rewind and use the ink film again.**

*2 Replacement batteries may have a different capacity from that of the supplied batteries.

To place an order for KX-FA52X online

Visit our web site:

<https://www.pas-europe.com/>

1.3 Button descriptions of the base unit

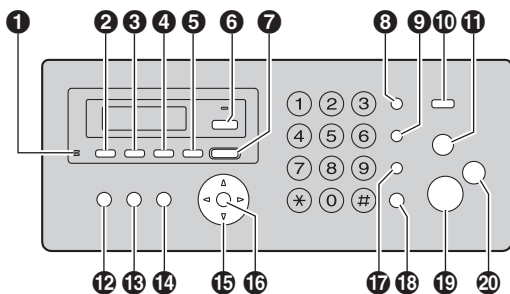

1 [MIC] (Microphone)

- The built-in microphone.

2 [GREETING REC]

- To record a greeting message (page 38).

3 [GREETING CHECK]

- To check a greeting message (page 38).

4 [MEMO]

- To record a memo message (page 39).

5 [ERASE]

- To erase messages (page 38, 38).

6 [AUTO ANSWER]

- To turn the auto answer setting ON/OFF (page 33, 34).

7 [PLAYBACK]

- To play messages (page 38).

8 [REDIAL]/[PAUSE]

- To redial the last number dialed. If the line is busy when you make a call using the **[SP-PHONE]** button, the unit will automatically redial the number up to 11 times for phone calls and 5 times for faxes.

- To insert a pause during dialling.

9 [RECALL]

- To access special telephone services or for transferring extension calls.
- The recall/flash time can be changed (feature #72 on page 46).

10 [CALLER ID]

- To use Caller ID features (page 28).

11 [STOP]

- To stop an operation or programming session.
- To erase a character/number (page 53).

12 [LOCATOR]/[INTERCOM]

- To make/answer intercom calls (page 50).
- To page or locate a cordless handset (page 51).

13 [PRINT REPORT]

- To print lists and reports for reference purposes (page 68).

14 [MENU]

- To start or exit programming.

15 Navigator/[PHONEBOOK]/[VOLUME]

- To search for a stored item (page 26, 31).
- To select features or feature settings during programming (page 42).
- To adjust the volume (page 22).
- To open a phonebook.

16 [SET]

- To store a setting during programming.

17 [MUTE]

- To mute your voice during a conversation. Press again to resume the conversation.

18 [SP-PHONE]

- For speakerphone operation.

19 [FAX START]

- To send or receive a fax.

20 [COPY]

- To copy a document (page 37).

1.4 Button descriptions of the cordless handset

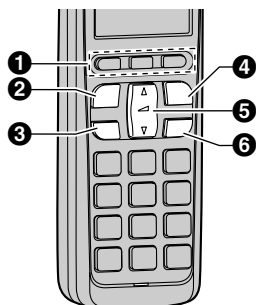

1 Soft keys

- To select the features or operations displayed directly above each key (page 13).

2 [↶] (Talk)

- To make/answer calls (page 24, 24).

3 [☎] (Speakerphone)

- For speakerphone operation.

4 [⏻] (Off/Power)

- To turn power ON/OFF (page 21).
- To hang up (page 24, 24).
- To stop an operation or programming.

5 Navigator

- To adjust the receiver or speaker volume (up or down) while talking (page 21).
- To scroll through (up or down) various lists or items (page 25).
- To move the cursor (left or right) to edit number or name.

6 [R/⊙] (Recall)

- To access special telephone services or for transferring extension calls.
- The recall/flash time can be changed (feature #72 on page 46).
- To set the alarm feature (page 49).

1.5 Display descriptions of the cordless handset

Display items

Display item	Meaning
∇	Within range of a base unit <ul style="list-style-type: none"> When flashing: Cordless handset is searching for base unit. (page 60)
⋮))	Paging, intercom mode.

Display item	Meaning
	Cordless handset is on an outside call.
	Missed call*1 (page 27)
	When displayed next to the battery icon: Auto answer setting is ON. (page 34) <ul style="list-style-type: none"> When feature #10 is set to "GREETING ONLY", ☎ will be displayed.
	When displayed with a number: New messages have been recorded. (page 39)
	Answering machine answers calls with a greeting message and caller messages are not recorded. (page 40)
	Battery level
	Alarm is ON. (page 49)
	Ringer volume is OFF. (page 21)
	New voice mail message received.*2
	<ul style="list-style-type: none"> Someone is using the line. Answering machine is being used by another cordless handset.

*1 Caller ID subscribers only

*2 Voice mail subscribers only

Soft keys



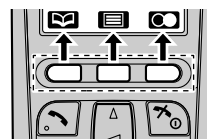



The cordless handset features 3 soft keys. By pressing a soft key, you can select the feature shown directly above it on the display.



Soft key icons

Soft key icon	Action
	Return to the previous screen.
	Display the menu.
	Accept the current selection.
	Display a previously dialed telephone number.
	Open the cordless handset phonebook.
	Display the character entry mode for phonebook search. (page 25)
	Turn the key lock feature OFF. (page 24)
	Select a character entry mode.

1. Introduction and Installation

Soft key icon	Action
	Stop recording or playback.
	Insert a dialling pause.
	Erase the selected item.
	Allow you to make an intercom call.
	Switch the screen. (page 27)
	Erase a number/character.
	Put the call on mute.

Symbols used in these operating instructions

Symbol	Meaning
" "	Select the words in quotations shown on the display (e.g., "Time Settings") by pressing [▲] or [▼]

1.6 Overview

1.6.1 Base unit

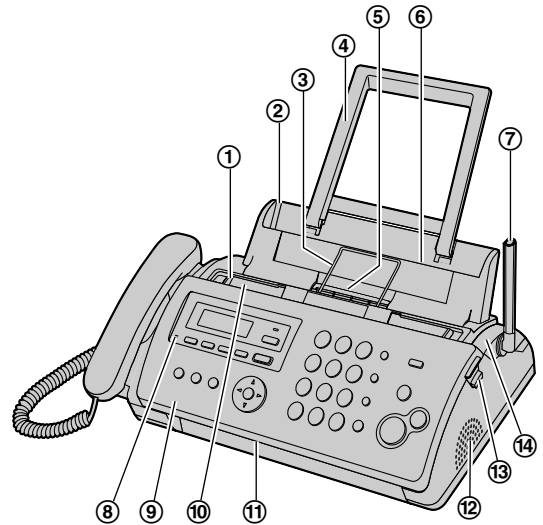

* The pictured model is KX-FC275.

- ① Document guides
- ② Paper tray
- ③ Metal recording paper guide
- ④ Paper support
- ⑤ Recording paper exit
- ⑥ Recording paper entrance
- ⑦ Antenna
- ⑧ Microphone
- ⑨ Front cover
- ⑩ Document entrance
- ⑪ Document exit
- ⑫ Speaker
- ⑬ Green button (Back cover release button)
- ⑭ Back cover

Removing the shipping tape

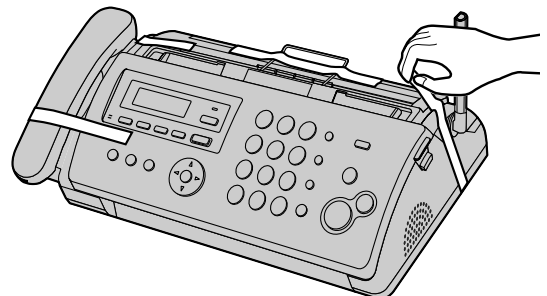

* The pictured model is KX-FC275.

Note:

- Shipping tape positions are subject to change without notice.

1.6.2 Cordless handset

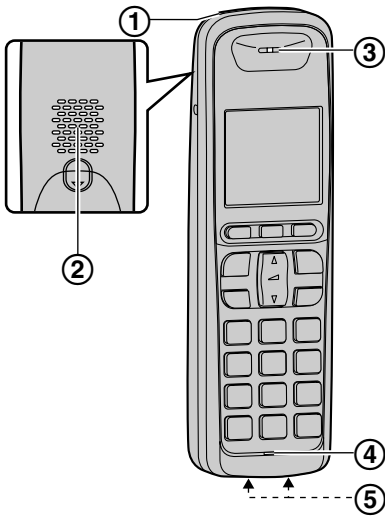

- ① Charge indicator
Ringer indicator
- ② Speaker
- ③ Receiver
- ④ Microphone
- ⑤ Charge contacts

- 2 Release the back cover by pushing the green button (①).

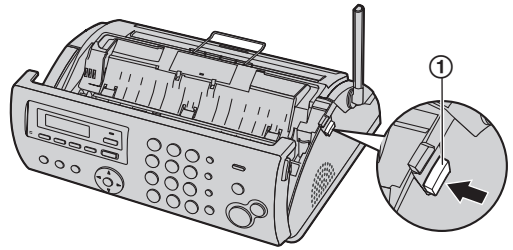

- 3 Open the back cover.

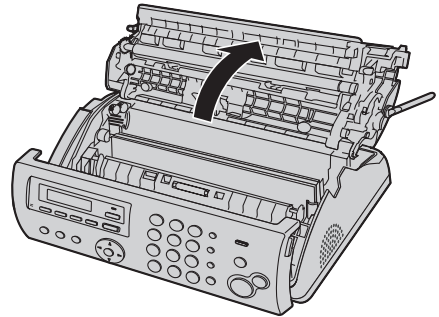

- 4 Insert the blue gear of the ink film roll into the front left slot of the unit (②) and the white gear of the ink film roll into the rear left slot of the unit (③).
 - The ink film is safe to touch and will not rub off on your hands like carbon paper.
 - Make sure the blue gear (②) and white gear (③) are installed as shown.

1.7 Ink film

The supplied film roll is a starter ink film.

- 1 Open the front cover.

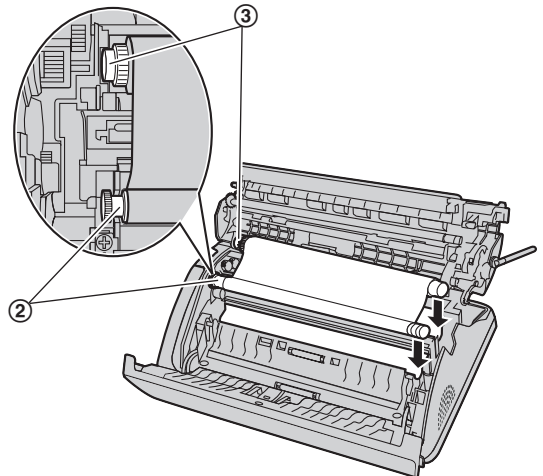
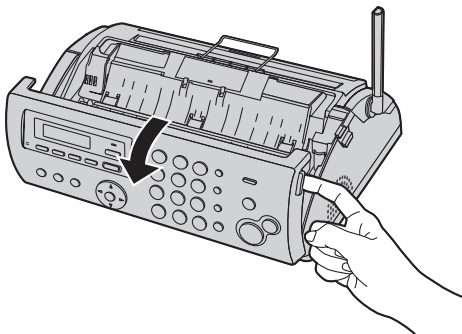

1. Introduction and Installation

- 5 Turn the blue gear (④) in the direction of the arrow until the ink film is tight (⑤) and at least one layer of ink film is wrapped around the blue core (⑥).

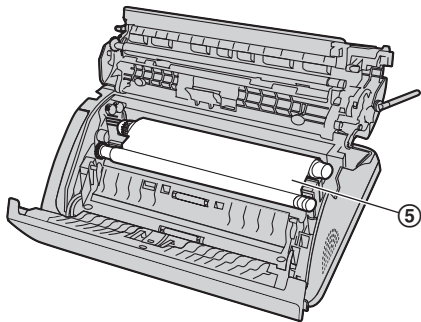
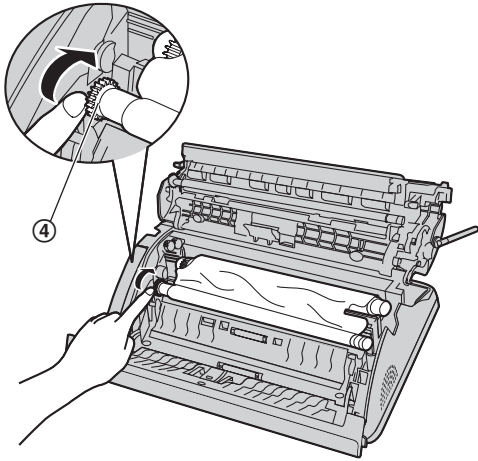

Correct

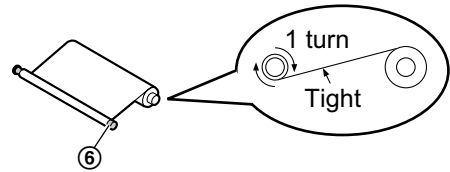

Incorrect

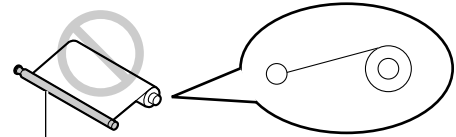

No ink film is wrapped around the blue core.

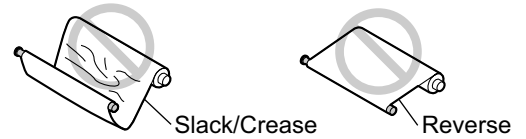

- 6 Close the back cover securely by pushing down on the dotted area at both ends (⑦).

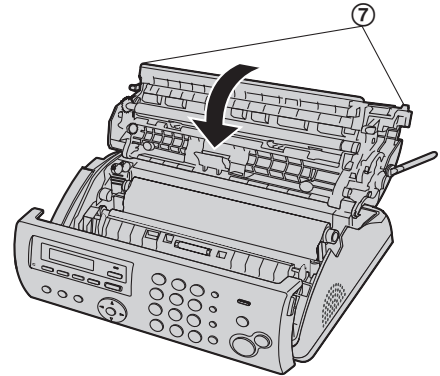

- 7 Close the front cover securely.

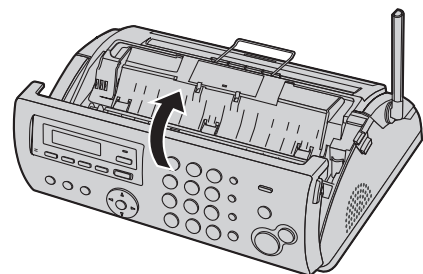

1.8 Paper tray

Pull up the metal recording paper guide (①), then install the paper tray (②).

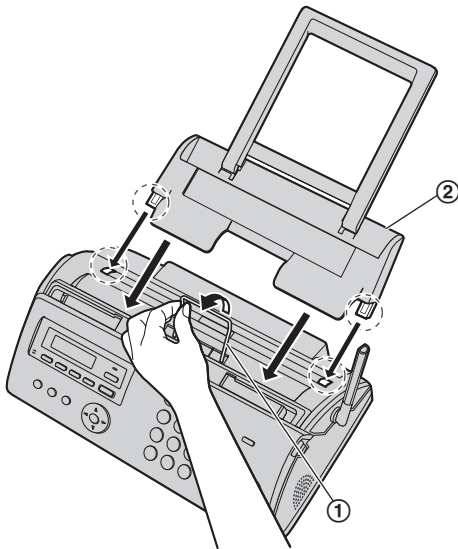

- Make sure the arrows on the paper tray and the unit match.

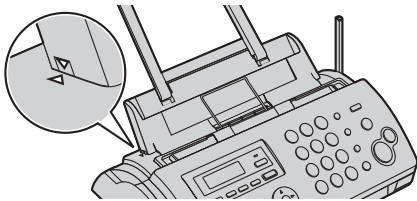

- If the paper support is folded, unfold it.

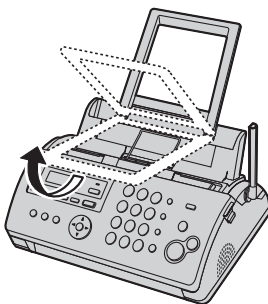

1.9 Recording paper

The unit can hold up to 20 sheets of 64 g/m² to 80 g/m² paper.

Note for recording paper:

- Do not use the following types of paper:

- Paper with a cotton and/or fibre content that is over 20 %, such as letterhead paper or paper used for resumes
- Extremely smooth or shiny paper, or paper that is highly textured
- Coated, damaged or wrinkled paper
- Paper with foreign objects attached, such as tabs or staples
- Paper which has dust, lint or oil stains
- Paper that will melt, vaporize, discolour, scorch or emit dangerous fumes near 200 °C, such as vellum paper. These materials may transfer onto the fusing roller and cause damage.
- Moist paper
- Some paper only accepts print on one side. Try using the other side of the paper if you are not happy with the print quality or if misfeeding occurs.
- For proper paper feeding and best print quality, we recommend using long-grained paper.
- Do not use paper of different types or thickness at the same time. This may cause a paper jam.
- Avoid double-sided printing.
- Do not use paper printed from this unit for double-sided printing with other copiers or printers. This may cause a paper jam.
- To avoid curling, do not open paper packs until you are ready to use the paper. Store unused paper in the original packaging, in a cool and dry location.
- For customers who live in high humidity areas: Please be sure to store paper in an air-conditioned room at all times. If you print using moist paper, it may cause paper jam.
- 1. Fan the paper to prevent paper jams.

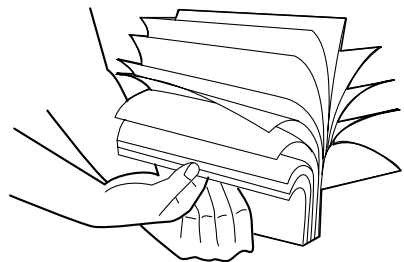

1. Introduction and Installation

2. Insert the paper gently, print-side down (①).
 - Do not force the paper into the paper tray.

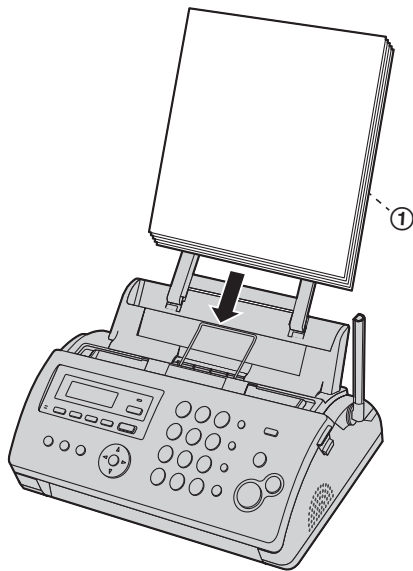

- If the paper is not inserted correctly, remove all of the installed paper, and re-install it gently. Otherwise the paper may jam.

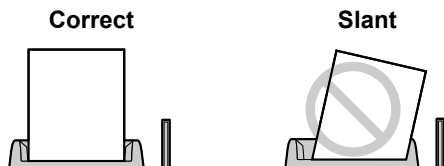

Note:

- Remove all of the installed paper before adding paper.

1.10 Handset cord (KX-FC275 only)

Connect the handset cord (①).

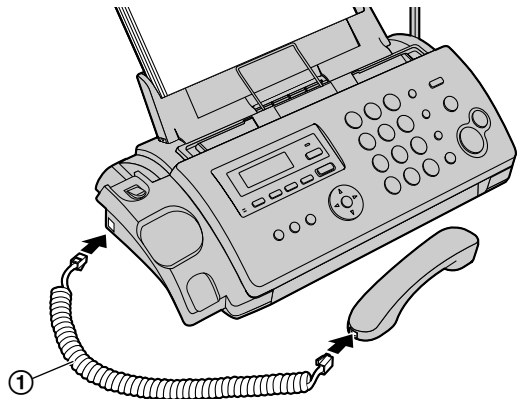

1.11 Battery installation / replacement

Important:

- **USE ONLY Ni-MH batteries AAA (R03) size.**
Do NOT use alkaline/Manganese/Ni-Cd batteries etc.

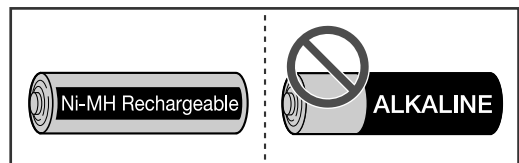

- Use the supplied rechargeable batteries. For replacement, we recommend using the Panasonic rechargeable batteries noted on page 5, 11.
- Wipe the battery ends (+, -) with a dry cloth.
- Avoid touching the battery ends (+, -) or the unit contacts.
- Confirm correct polarities (+, -).
- Install the batteries without touching the battery ends (+, -) or the unit contacts.

- 1 Press the notch on the cordless handset cover firmly, and slide the cover.
 - When replacing batteries, remove the old batteries positive (\oplus) terminal first.

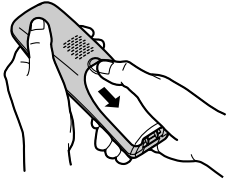

- 2 Insert the batteries negative (\ominus) terminal first. Close the cordless handset cover.

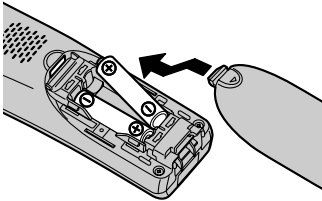

- | |
|--|
| <ul style="list-style-type: none">• When the language selection is displayed, see page 49. |
|--|

2. Preparation

2.1 Connections

Important:

- This unit is not designed for making emergency telephone calls when the power fails. We recommend connecting a corded-type telephone (without AC adaptor) to the same telephone line so in the case of power failure you will still be able to make emergency calls.

2.1.1 Base unit

- ① Telephone line cord
 - Connect to telephone network.
- ② Mains lead
 - Connect to Household Mains Supply (220 V – 240 V, 50 Hz).

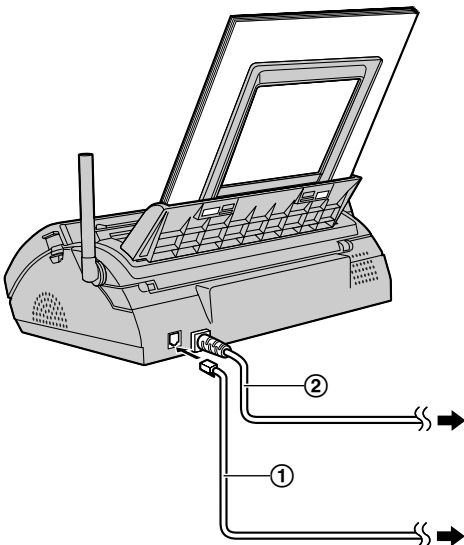

Caution:

- The mains lead must remain connected at all times.
- Never install telephone wiring during a lightning storm.
- When you operate this product, the power outlet should be near the product and easily accessible.
- Be sure to use the telephone line cord supplied with this unit.
- Do not extend the telephone line cord.

Note:

- If any other device is connected to the same telephone line, this unit may disturb the network condition of the device.

- If you use the unit with a computer and your internet provider instructs you to install a filter (③), please connect it as follows.

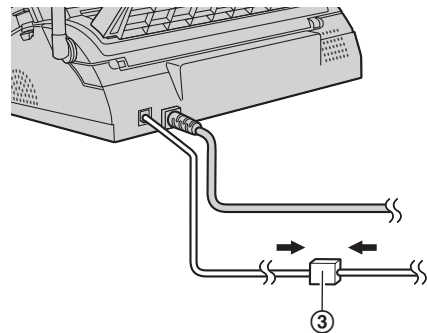

2.1.2 Charger unit (KX-FC275 only)

- ① AC adaptor
 - Connect to Household Mains Supply (220 V – 240 V, 50 Hz).
- ② Hooks
 - Fasten the AC adaptor cord to prevent it from being disconnected.
- ③ Screws (not supplied)
 - The charger can be mounted on the wall, if required.

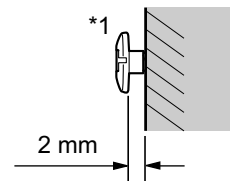
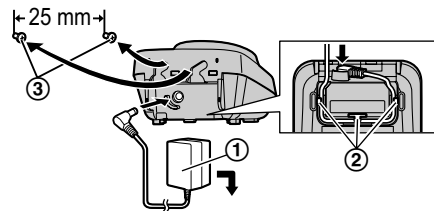

*1 Use screws longer than 20 mm.

Caution:

- **USE ONLY WITH** the supplied Panasonic AC adaptor.
- The AC adaptor must remain connected at all times. (It is normal for the adaptor to feel warm during use.)
- The AC adaptor should be connected to a vertically oriented or floor-mounted AC outlet. Do not connect the AC adaptor to a ceiling-mounted AC outlet, as the weight of the adaptor may cause it to become disconnected.

- Press the AC adaptor plug firmly.

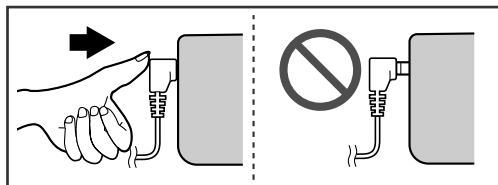

cloth once a month. Clean more often if the unit is exposed to grease, dust, or high humidity.

Battery level

Icon	Battery level
	High
	Medium
	Low
	Needs charging.

Panasonic Ni-MH battery performance (supplied batteries)

Operation	Operating time
In continuous use	18 hours max.
Not in use (standby)	170 hours max.

Note:

- It is normal for batteries not to reach full capacity at the initial charge. Maximum battery performance is reached after a few complete cycles of charge/discharge (use).
- Actual battery performance depends on a combination of how often the cordless handset is in use and how often it is not in use (standby).
- Even after the cordless handset is fully charged, the cordless handset can be left on the base unit or charger without any ill effect on the batteries.
- The battery level may not be displayed correctly after you replace the batteries. In this case, place the cordless handset on the base unit or charger and let it charge for at least 7 hours.

2.2 Battery charge

Place the cordless handset on the base unit or charger for about **7 hours** before initial use. Confirm “Charging” is displayed.

When the batteries are fully charged, the charge indicator (①) goes OFF.

KX-FC275

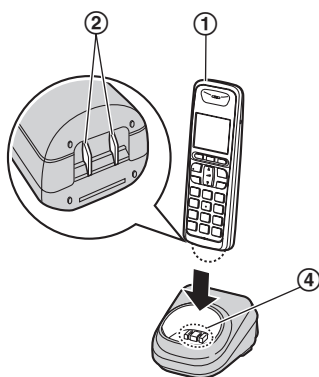

KX-FC265

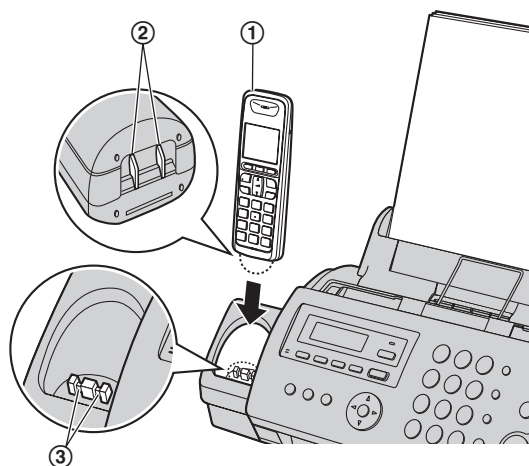

Note:

- It is normal for the cordless handset to feel warm during charging.
- Clean the charge contacts of the cordless handset (②), base unit (③) or charger (④) with a soft and dry

2.3 Turning the cordless handset power ON/OFF

Power ON

Press [**⏻**] for about 1 second.

Power OFF

Press [**⏻**] for about 2 seconds.

2.4 Adjusting cordless handset volume

Ringer volume

- 1.
2. Press [**▲**] or [**▼**] to select “Handset Setup”. → **OK**
3. Press [**▲**] or [**▼**] to select “Ringer Setup”. → **OK**
4. Press [**▲**] or [**▼**] to select “Ringer Volume”. → **OK**

2. Preparation

5. Press **[▲]** or **[▼]** to select the desired volume. → **OK** → **[*⓪]**

Note:

- When receiving a call, you can adjust the ringer volume by pressing **[▲]** or **[▼]**.
- When the ringer volume is turned OFF, **ⓧ** is displayed and the cordless handset does not ring for outside calls.
However even when the ringer volume is set to OFF, the cordless handset rings:
 - at the low level for alarm (page 49) and intercom calls (page 50)
 - at the high level for paging (page 51)

Cordless handset receiver volume

While using the receiver, press **[▲]** or **[▼]**.

Speaker volume

While using the speakerphone, press **[▲]** or **[▼]**.

2.5 Adjusting base unit volume

Ringer volume

While the unit is idle, press **[+]** or **[-]**.

- The ringer volume can only be adjusted if there are no documents in the document feeder entrance.

To turn the ringer OFF

Press **[-]** repeatedly to display “**RINGER OFF= OK?**”. → **[SET]**

- The base unit will not ring for outside calls. The base unit will ring at the low level for intercom calls.
- To turn the ringer back ON, press **[+]**.

Handset receiver volume (KX-FC275 only)

While using the receiver, press **[+]** or **[-]**.

Speaker volume

While using the speakerphone, press **[+]** or **[-]**.

2.6 Date and time

The date and time can be set using either the cordless handset or the base unit.

- The other party's fax machine will print the date and time on the top of each page you send according to your unit's date and time setting.
- If a power failure occurs, the date and time setting may be lost. If the correct date and time is not displayed after the power has been restored, set the date and time again.

2.6.1 With the cordless handset

1 **[☰]**

2 “**Handset Setup**” → **OK**

3 “**Time Settings**” → **OK**

4 “**Set Date/Time**” → **OK**

5 Enter the current date, month, and year. → **OK**
Example: 3 August, 2010
[0][3] [0][8] [1][0]

6 Enter the current hour and minute.
Example: 10:15 (12 hour clock format)
[1][0] [1][5]

- You can select 24-hour or 12-hour clock format (“**AM**” or “**PM**”) by pressing **[*]**.

7 **OK** → **[*⓪]**

To correct a mistake

Press **[▲]** or **[▼]** to move the cursor to the incorrect number, and make the correction.

2.6.2 With the base unit

Important:

- If **⓪** is displayed on the base unit, either the date and time has not been set or the setting has been lost (due to a power failure, etc.). Set the date and time by pressing **[SET]**, then follow step 2 to 4.

1 **[MENU]** → **[#][0][1]** → **[SET]**

2 Enter the current date/month/year by selecting 2 digits for each.
Example: 3 August, 2010
[0][3] [0][8] [1][0]

3 Enter the current hour/minute by selecting 2 digits for each.
Example: 10:15 PM (12 hour clock format)
1. **[1][0] [1][5]**

2. Press **[*]** repeatedly to select “**PM**”.

Press **[*]** repeatedly to select “**AM**” or “**PM**”, or 24-hour time entry.

4 **[SET]**

5 Press **[MENU]** to exit.

To correct a mistake

Press **[◀]** or **[▶]** to move the cursor to the incorrect number, and make the correction.

If you have subscribed to a Caller ID service

The date and time will be automatically set according to the received caller information.

- If the time has not previously been set, Caller ID will not adjust the clock.
- You can turn this feature OFF (feature #33 on page 44).

2.7 Your logo

You can program your logo (name, company name, etc.) so that it appears on the top of each page sent.

With the base unit

- 1 **[MENU]** → **[#][0][2]** → **[SET]**
 - 2 Enter your logo, up to 30 characters (see page 53 for character entry).
 - To enter a hyphen, press **[RECALL]**.
 - To enter a space, press **[MUTE]**.
 - 3 **[SET]**
 - 4 Press **[MENU]** to exit.
-

To correct a mistake

Press **[◀]** or **[▶]** to move the cursor to the incorrect character, and make the correction.

- To erase all of the characters, press and hold **[STOP]**.
-

2.8 Your fax number

You can program your fax number so that it appears on the top of each page sent.

With the base unit

- 1 **[MENU]** → **[#][0][3]** → **[SET]**
 - 2 Enter your fax number, up to 20 digits.
 - To enter a "+", press **[*]**.
 - To enter a space, press **[#]**.
 - To enter a hyphen, press **[RECALL]**.
 - To erase a number, press **[STOP]**.
 - 3 **[SET]**
 - 4 Press **[MENU]** to exit.
-

To correct a mistake

Press **[◀]** or **[▶]** to move the cursor to the incorrect number, and make the correction.

- To erase all of the numbers, press and hold **[STOP]**.
-

3. Telephone

3.1 Making phone calls

3.1.1 With the cordless handset

- 1 Lift the cordless handset and dial the telephone number.
 - To correct a digit, press **C**.
- 2 **[↶]**
 - To make hands-free telephone calls, press **[☎]**.
- 3 To hang up, press **[✕⓪]** or place the cordless handset on the base unit or charger.

Note:

- While talking using **[↶]**, you can switch to a hands-free telephone conversation by pressing **[☎]**. To switch back, press **[↶]**.
- For best performance, use the speakerphone in a quiet environment.

To mute your conversation

While mute is turned ON, you can hear the other party, but the other party cannot hear you.

1. Press **[M]** during conversation.
 - **[M]** flashes.
2. To return to the conversation, press **[M]** again.

To redial using the redial list (Memory redial)

The last 10 telephone numbers dialed from the cordless handset are stored in the redial list (each 24 digits max.).

1. **[M]**
2. Press **[▲]** or **[▼]** to select the desired number.
3. **[↶]** or **[☎]**

To erase numbers in the redial list

1. **[M]**
2. Press **[▲]** or **[▼]** repeatedly to select the desired number. → **[M]** → **OK**
3. "Yes" → **OK** → **[✕⓪]**

Key lock

The cordless handset can be locked so that no calls or settings can be made. Incoming calls can be answered, but all other functions are disabled while key lock is ON.

To turn key lock ON, press **[M]** for about 3 seconds.

- **[M]** is displayed.
- To turn key lock OFF, press **[M]** for about 3 seconds.

Note:

- Calls to emergency numbers cannot be made until key lock is turned OFF.

Pause (for PBX/long distance service users)

A pause is sometimes required when making calls using a PBX or long distance service. When storing a calling card access number and/or PIN in the phonebook, a pause is also needed (page 26).

Example: If you need to dial the line access number "0" when making outside calls with a PBX:

1. **[0]** → **P**
2. Dial the telephone number. → **[↶]**

Note:

- A 3 second pause is inserted each time **P** is pressed. Repeat as needed to create longer pauses.

3.1.2 With the base unit

KX-FC275:

- 1 Lift the handset or press **[SP-PHONE]**.
- 2 Dial the telephone number.
- 3 To hang up, replace the handset or press **[SP-PHONE]**.

KX-FC265:

- 1 **[SP-PHONE]**
- 2 Dial the telephone number.
- 3 To hang up, press **[SP-PHONE]**.

To redial the last number dialed from the base unit

KX-FC275:

Lift the handset or press **[SP-PHONE]**. → **[REDIAL]**

KX-FC265:

[SP-PHONE] → **[REDIAL]**

- If **[SP-PHONE]** is pressed and the line is busy, the unit will automatically redial the number up to 11 times.

To mute your conversation

When the call is muted, you will be able to hear the other party but the other party will not be able to hear you.

Press **[MUTE]**.

- To release the mute, press **[MUTE]**.

3.2 Answering phone calls

3.2.1 With the cordless handset

When a call is being received, the ringer indicator on the cordless handset flashes.

- 1 Lift the cordless handset and press **[↶]** or **[☎]** when the cordless handset rings.
 - You can also answer the call by pressing any dial key from **[0]** to **[9]**, **[*]** or **[#]** (**Any key talk feature**).
- 2 To hang up, press **[✕⓪]** or place the cordless handset on the base unit or charger.

Auto talk feature (Cordless handset)

You can answer calls simply by lifting the cordless handset off the base unit or charger. You do not need to press **[↶]**. To turn this feature ON, see page 47.

3.2.2 With the base unit**KX-FC275:**

- 1 Lift the handset or press **[SP-PHONE]** and talk into **[MIC]**.
- 2 To hang up, replace the handset or press **[SP-PHONE]**.

KX-FC265:

- 1 Press **[SP-PHONE]** and talk into **[MIC]**.
- 2 To hang up, press **[SP-PHONE]**.



3.3 Cordless handset phonebook

You can store 100 items to the cordless handset phonebook.

When the system has additional cordless handsets (page 50), each cordless handset can have its own phonebook.

- The base unit has its own individual phonebook (page 26).
- You can copy phonebook items between the base unit and the cordless handset, or between 2 cordless handsets (page 52).

3.3.1 Storing phonebook items

- 1  → 
- 2 "New Entry" → **OK**
- 3 Enter the name, up to 16 characters (see page 53 for character entry). → **OK**
 - You can change the character entry mode by pressing **[1A/2]** (page 53).
- 4 Enter the telephone number, up to 24 digits. → **OK** 2 times
 - To add other entries, repeat from step 3.
- 5 **[↶⊙]**

3.3.2 Making a phone call using the phonebook

- 1 
- 2 Press **[▲]** or **[▼]** repeatedly to display the desired item.
 - You can scroll through the phonebook item by pressing and holding **[▼]** or **[▲]**.
- 3 **[↶]**

To search for a name by initial

1. 
 - Change the character entry mode if necessary: **[ABC]** → Press **[▼]** or **[▲]** to select the character entry mode. → **OK**
2. Press the dial key (**[0]** to **[9]**) which contains the character you are searching for (page 53).
 - Press the same dial key repeatedly to display the first item corresponding to each character located on that dial key.
 - If there is no item corresponding to the character you selected, the next item is displayed.
3. Press **[▲]** or **[▼]** repeatedly to scroll through the phonebook if necessary.



3.3.3 Editing a stored item**Changing a name, telephone number**

1. Find the desired item (page 25). → 
2. "Edit" → **OK**
3. Edit the name if necessary. For further details, see the storing procedure on page 25. → **OK**
4. Edit the telephone number if necessary. For further details, see the storing procedure on page 25. → **OK** 2 times
5. **[↶⊙]**

3.3.4 Erasing a stored item**To erase a specific item**

1. Find the desired item (page 25). → 
2. "Erase" → **OK**
3. "Yes" → **OK** → **[↶⊙]**

To erase all items

1.  → 
2. "Erase All" → **OK**
3. "Yes" → **OK**
4. "Yes" → **OK** → **[↶⊙]**

3.4 Chain dial (Cordless handset only)

This feature allows you to dial telephone numbers in the cordless handset phonebook while you are on a call. This feature can be used, for example, to dial a calling card access number or bank account PIN that you have stored in the cordless handset phonebook, without having to dial manually.

- 1 During an outside call, press . → **OK**
- 2 Press **[▲]** or **[▼]** repeatedly to select the desired item.
 - To search by first character (index search), see page 25.

3. Telephone

- 3 Press **OK** to dial the number.

Note:

- When storing a calling card access number and your PIN in the phonebook as one phonebook item, press **P** to add pauses after the number and PIN as necessary (page 24).

3.5 Base unit phonebook

You can store 100 items to the base unit phonebook.

- The cordless handset has its own individual phonebook (page 25).
- You can copy phonebook items between the base unit and the cordless handset (page 52).

3.5.1 Storing phonebook items

- 1 Press **[MENU]** repeatedly to display “**PHONEBOOK SET**”. → **[*]**
- 2 Enter the name, up to 16 characters (see page 53 for character entry). → **[SET]**
- 3 Enter the telephone number, up to 24 digits. → **[SET]**
 - To program other items, repeat steps 2 to 3.
- 4 **[MENU]**

3.5.2 Making a phone call using the phonebook

- 1 **[PHONEBOOK]**
- 2 Press **[+]** or **[-]** repeatedly to display the desired item.
- 3 **KX-FC275:**
Lift the handset or press **[SP-PHONE]**.
KX-FC265:
[SP-PHONE]

To search for a name by initial

1. **[PHONEBOOK]**
2. Press **[+]** or **[-]** to initiate the phonebook.
3. Press the dial key (**[0]** to **[9]**) which contains the character you are searching for (page 53).
 - Press the same dial key repeatedly to display the first item corresponding to each letter located on that dial key.
 - If there is no item corresponding to the letter you selected, press another dial key.
4. Press **[+]** or **[-]** repeatedly to scroll through the phonebook if necessary.

3.5.3 Editing a stored item

- 1 **[PHONEBOOK]**

- 2 Press **[+]** or **[-]** repeatedly to display the desired item. → **[MENU]** → **[*]**
- 3 Edit the name if necessary. → **[SET]**
- 4 Edit the telephone number if necessary. → **[SET]**

3.5.4 Erasing a stored item

- 1 **[PHONEBOOK]**
- 2 Press **[+]** or **[-]** repeatedly to display the desired item. → **[MENU]** → **[#]**
 - To cancel erasing, press **[STOP]**.
- 3 **[SET]**

3.5.5 Erasing all items

- 1 **[PHONEBOOK]** → **[ERASE]**
- 2 Press **[+]** or **[-]** repeatedly to select “**YES**”. → **[SET]**
 - To cancel erasing, press **[STOP]**.
- 3 **[SET]**

3.6 One touch dial (Base unit only)

Base unit dial keys **[1]** to **[9]** can each be used as a one touch dial key, allowing you to dial a number from the base unit's phonebook by simply pressing a dial key.

To assign an item to a one touch dial key

1. **[PHONEBOOK]**
2. Press **[+]** or **[-]** repeatedly to display the desired item. → **[MENU]** → **[0]**
3. Press **[+]** or **[-]** repeatedly to select a desired dial key.
 - When the dial key is already used as a one touch dial key, ✓ is displayed next to the dial key number. If you select this dial key, you can overwrite the previous assignment.
4. **[SET]** → **[SET]**
 - To program other items, repeat steps 2 to 4.
5. **[STOP]**

To make a call using a one touch dial key

1. Press and hold the desired one touch dial key (**[1]** to **[9]**).
 - You can view other one touch dial assignments by pressing **[+]** or **[-]**.
2. **KX-FC275:**
Lift the handset or press **[SP-PHONE]**.
KX-FC265:
[SP-PHONE]

To erase a one touch dial assignment

1. Press and hold the desired one touch dial key ([1] to [9]). → [ERASE]
 - To cancel erasing, press [STOP].
2. [SET]

Note:

- The corresponding base unit phonebook item will not be erased.

3.7 Caller ID service

This unit is compatible with the Caller ID service offered by your local telephone company. To use this unit's Caller ID features, you must subscribe to a Caller ID service.

Important:

- This unit is designed in accordance with the ETS (European Telecommunication Standard) and only supports the basic CLIP (Calling Line Identification Presentation) features.
- This unit will only display the caller's telephone number and name.
- This unit will not support future additional telephone services.
- Depending on the service of the local telephone company, the date/time of the call or the caller's name may not be displayed.

Make sure the following ring count is set to 2 or more rings beforehand.

- FAX ring count (feature #06 on page 42)
- TEL/FAX ring count (feature #78 on page 46)
- The name display service may not be available in some areas. For further information, please contact your telephone company.

3.7.1 How Caller ID is displayed

The calling party's name or telephone number will be displayed. You have the option of whether or not to answer the call.

The unit will automatically store caller information (name, telephone number and date and time of the call) from the 50 most recent calls. It is possible to view caller information on the display (page 27) or print the entire Caller ID list (page 68).

- When caller information is received and it matches a telephone number stored in the unit's phonebook, the stored name will be displayed.
- If the unit is connected to a PBX (Private Branch Exchange) system, caller information may not be received properly. Consult your PBX supplier.
- If the unit cannot receive caller information, the following is displayed:
"OUT OF AREA"/"Out of Area": The caller dials from an area which does not provide a Caller ID service.

"PRIVATE CALLER"/"Private Caller": The caller requests not to send caller information.

Missed calls

If a call is not answered, the unit treats the call as a missed call. The number of missed calls are shown on the display (the cordless handset also shows →). This lets you know if you should view the caller list to see who called while you were away.

To confirm caller information by printing the Caller ID list (Base unit only)

- To print manually, see page 68.
- To print automatically after every 50 new calls, activate feature #26 (page 44).

For call waiting or Call Waiting Caller ID service users

To use call waiting, you must first subscribe to the call waiting service of your service provider/telephone company.

This feature allows you to receive calls while you are already talking on the telephone. If you receive a call while on the telephone, you will hear a call waiting tone.

If you subscribe to both Caller ID and Call Waiting with Caller ID services, the 2nd caller's information is displayed on the base unit or cordless handset that is in use after you hear the call waiting tone.

1. Press [RECALL] on the base unit or [R/⊕] on the cordless handset to answer the 2nd call.
2. To switch between calls, press [RECALL] on the base unit or [R/⊕] on the cordless handset.

Note:

- Please contact your service provider/telephone company for details and availability of this service in your area.

3.8 Viewing and calling back

Important:

- If the area code of the received telephone number is the same as yours, the area code may need to be deleted before calling back. This may only apply to some areas. To edit the number, see page 28.
- Make sure the unit's date and time setting is correct (page 22).

3.8.1 With the cordless handset

- 1 
- 2 "Caller List" → **OK**
- 3 Press [▼] to search from the most recent call, or press [▲] to search from the oldest call.

3. Telephone

- If the other party's name is displayed on the screen, you can switch the screen between the name and its telephone number by pressing  repeatedly.
- To erase the item, press **X**. → "Yes" → **OK**

4 Press  or  to start dialling.

3.8.2 With the base unit

1 **[CALLER ID]**

2 Press **[−]** to search from the most recent call, or press **[+]** to search from the oldest call.

3 **KX-FC275:**

Lift the handset or press **[SP-PHONE]** to start dialling.

KX-FC265:

Press **[SP-PHONE]** to start dialling.

- To send a fax, insert the document FACE DOWN and press **[FAX START]**.
-

To change the way caller information is displayed

Press **[CALLER ID]** repeatedly after step 2 to change name/telephone number information.

3.8.3 Symbols and operations for caller information

What "✓" means

If the item has already been viewed or answered, "✓" is displayed, even if it was viewed or answered using another unit.

To stop viewing

Press **[⏏]** on cordless handset or **[STOP]** on the base unit.

3.9 Editing a caller's telephone number before calling back

3.9.1 With the cordless handset

1 

2 "Caller List" → **OK**

3 Press **[▲]** or **[▼]** repeatedly to display the desired item.

- If the other party's name is displayed on the screen, you can switch the screen between the name and its telephone number by pressing  repeatedly.

4  → "Edit & Call" → **OK**

5 Edit the number.

- Press dial key (**[0]** to **[9]**) to add, **C** to delete.
-

6  or 

3.9.2 With the base unit

1 **[CALLER ID]**

2 Press **[+]** or **[−]** repeatedly to display the desired item.

3 Press **[CALLER ID]** repeatedly to display the telephone number.

4 Press **[*]**, then edit the number.

- Press dial key (**[0]** to **[9]**) to add, **[STOP]** to delete.

5 **KX-FC275:**

Lift the handset or press **[SP-PHONE]**.

KX-FC265:

[SP-PHONE]

- To send a fax, insert the document FACE DOWN and press **[FAX START]**.
-

3.10 Erasing caller information

3.10.1 With the cordless handset

1 

2 "Caller List" → **OK**

3 Press **[▲]** or **[▼]** repeatedly to display the desired item. → 

4 "Erase" → **OK**

- To erase all items, select "Erase All". → **OK**

5 "Yes" → **OK** → **[⏏]**

3.10.2 With the base unit

To erase all caller information

1 Press **[MENU]** repeatedly to display "CALLER SETUP". → **[SET]**

- "CALL LIST ERASE" will be displayed.

2 **[SET]**

- To cancel erasing, press **[STOP]**, then **[MENU]**.

3 **[SET]** → **[STOP]**



To erase specific caller information

1 **[CALLER ID]**

2 Press **[+]** or **[−]** repeatedly to display the desired item. → **[ERASE]** → **[STOP]**

3.11 Storing caller information into the phonebook

3.11.1 Into the cordless handset

- 1 
- 2 "Caller List" → **OK**
- 3 Press [**▲**] or [**▼**] repeatedly to display the desired item. → 
- 4 "Add Phonebook" → **OK**
- 5 If a name is required, enter the name, up to 16 characters (see page 53 for character entry). → **OK**
- 6 Enter the telephone number, up to 24 digits. → **OK** → **OK** → [**☒**]

3.11.2 Into the base unit

- 1 [**CALLER ID**]
- 2 Press [**+**] or [**-**] repeatedly to display the desired item. → [**MENU**]
- 3 If a name is required, enter up to 16 characters for the name (see page 53 for character entry). → [**SET**] → [**SET**]



4. Fax

4.1 Sending a fax manually

- 1 Adjust the width of the document guides to fit the actual size of the document.
- 2 Insert the document (up to 10 pages) FACE DOWN until a single beep is heard and the unit grasps the document.
- 3 If necessary, press **[+]** or **[-]** repeatedly to select the desired resolution.
- 4 **KX-FC275:**
Lift the handset or press **[SP-PHONE]**.
KX-FC265:
[SP-PHONE]
- 5 Dial the fax number.
- 6 **When a fax tone is heard:**
Press **[FAX START]**.
When the other party answers your call:
Ask them to press their start button. When the fax tone is heard, press **[FAX START]**.

To select the resolution

Select the desired resolution according to the character size.

- “**STANDARD**”: For normal-sized characters.
- “**FINE**”: For small-sized characters.
- “**SUPER FINE**”: For very small-sized characters.
- “**PHOTO**”: For photographs, shaded drawings, etc.
- Using the “**FINE**”, “**SUPER FINE**” and “**PHOTO**” settings will increase transmission time.

To redial the last number

[REDIAL] → **[FAX START]**

- If the line is busy, the unit will automatically redial the number up to 5 times.
- To cancel redialling, press **[STOP]**.

To send more than 10 pages at a time

Insert the first 10 pages of the document. Add the other pages (up to 10 at a time) on top of the previously inserted pages while the last page is being fed into the unit.

Pre-dialling a fax number

1. Enter the fax number.
2. Insert the document.
3. **[FAX START]**

Sending from memory (Quick scan feature)

To use this feature, activate feature #34 (page 44) beforehand.

1. Insert the document.
2. Enter the fax number. → **[FAX START]**
 - If the document exceeds the memory capacity, transmission will be cancelled and this feature will be

turned OFF automatically. You must send the entire document manually.

- This feature cannot be used if the handset is being used (KX-FC275 only), or if **[SP-PHONE]** on the base unit, **[☎]** or **[☎]** on the cordless handset is pressed.

To stop sending

Press **[STOP]**.

To send a fax using the cordless handset

1. While talking to the other party, insert the document, then press **[☎]**.
2. Select “**Fax Start**”, then press **[OK]**.

Printing a sending report

A sending report provides you with a printed record of transmission results (errors, etc.). To print the sending reports, make sure that feature #04 is activated (page 42). The default setting is “**ERROR**”. For an explanation of the messages, see page 55.

Printing a journal report

A journal report provides you with a printed record of the 30 most recent fax transmissions and receptions. To print it manually, see page 68. To print it automatically after every 30 new fax transmissions and receptions, make sure feature #22 is activated (page 43). For an explanation of the messages, see page 55.

4.2 Document requirements

Minimum document size

128 mm in width, 128 mm in length

Maximum document size

216 mm in width, 600 mm in length

Effective scanning area

- Shaded area will be scanned.

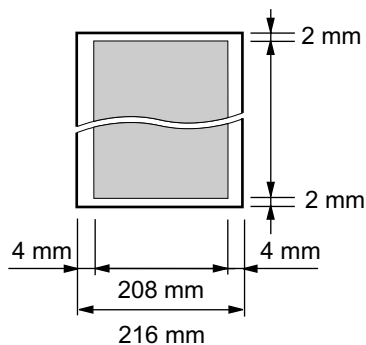

Document weight

- Single sheet:
45 g/m² to 90 g/m²
- Multiple sheets:
60 g/m² to 80 g/m²

Note:

- Remove clips, staples or other fasteners.
- Do not send the following types of documents: (Make a copy of the document using another copier and send the copy.)
 - Chemically treated paper such as carbon or carbonless duplicating paper
 - Electrostatically charged paper
 - Badly curled, creased or torn paper
 - Paper with a coated surface
 - Paper with a faint image
 - Paper with printing on the opposite side that can be seen through the other side, such as newsprint
- Check that ink, paste or correction fluid has dried completely.
- To send a document with a width of less than 210 mm, we recommend using a copy machine to copy the original document onto A4 or letter-sized paper, then sending the copied document.

4.3 Sending a fax using the phonebook and one touch dial

Before using this feature, store the desired names and telephone numbers into the base unit's phonebook (page 26) and the base unit's one touch dial (page 26).

- 1 Adjust the width of the document guides to fit the actual size of the document.
- 2 Insert the document (up to 10 pages) FACE DOWN until a single beep is heard and the unit grasps the document.
- 3 If necessary, press **[+]** or **[-]** repeatedly to select the desired resolution (page 30).
- 4 **Using the phonebook:**
 1. **[PHONEBOOK]**
 2. Press **[+]** or **[-]** repeatedly to display the desired item. → **[FAX START]**

Using one touch dial:

1. Press and hold the desired one touch dial key (**[1]** to **[9]**).
 - You can view other one touch dial assignments by pressing **[+]** or **[-]**.
2. **[FAX START]**

Fax auto redial

If the line is busy or if there is no answer, the unit will automatically redial the number up to 5 times.

- To cancel redialling, press **[STOP]**.

4.4 Broadcast transmission

By storing the base unit's phonebook items (page 26) into the broadcast memory, you can send the same document to multiple parties (up to 20). Your

programmed items will remain in the broadcast memory, allowing frequent re-use.

4.4.1 Programming items into the broadcast memory

- 1 Press **[MENU]** repeatedly to display "BROADCAST SET". → **[#]**
- 2 Press **[+]** or **[-]** repeatedly to display the desired item. → **[SET]**
 - The number in brackets indicates the number of registered items.
 - If you have programmed the wrong item, press **[STOP]** to erase the item.
 - To program other items, repeat step 2 (up to 20 items).
- 3 **[SET]**

4.4.2 Adding a new item into the broadcast memory

- 1 **[PHONEBOOK]**
- 2 Press **[+]** or **[-]** repeatedly to display "<BROADCAST>". → **[MENU]** → **[*]**
- 3 Press **[+]** or **[-]** repeatedly to display the desired item. → **[SET]**
 - To add other items, repeat step 3 (up to 20 items).
- 4 **[STOP]**

4.4.3 Erasing a stored item from the broadcast memory

- 1 **[PHONEBOOK]**
- 2 Press **[+]** or **[-]** repeatedly to display "<BROADCAST>". → **[MENU]** → **[#]**
- 3 Press **[+]** or **[-]** repeatedly to display the desired item you want to erase.
 - To cancel erasing, press **[STOP]**.
- 4 **[SET]** → **[SET]** → **[STOP]**

4.4.4 Sending the same document to pre-programmed parties

- 1 Insert the document FACE DOWN.
- 2 If necessary, press **[+]** or **[-]** repeatedly to select the desired resolution (page 30). → **[PHONEBOOK]**
- 3 Press **[+]** or **[-]** repeatedly to display "<BROADCAST>". → **[FAX START]**
 - After transmission, the unit will automatically print a report (**Broadcast sending report**).

4. Fax

Note:

- If you select “**FINE**”, “**SUPER FINE**” or “**PHOTO**” resolution, the number of pages that the unit can send will decrease.
- If the document exceeds the memory capacity, transmission will be cancelled.
- If a party is busy or does not answer, it will be skipped and redialled later up to 5 times.

To send the same document to a one-time group of items

1. Insert the document. → **[PHONEBOOK]**
2. Press **[+]** or **[-]** repeatedly to display “<ONE TIME BROAD>”. → **[SET]**
3. Press **[+]** or **[-]** repeatedly to display the desired party. → **[SET]**
 - If you have programmed the wrong item, press **[STOP]** to erase the item.
 - To program other parties, repeat step 3 (up to 20 items).
4. Press **[FAX START]** to start transmission to the programmed parties.

To cancel broadcast transmission

Press **[STOP]** repeatedly to display “**SEND CANCELLED?**”. → **[SET]**

4.5 Selecting the way to use your fax machine

Depending on your situation, select the way you prefer to use your fax machine.

- Use as a telephone answering machine and/or fax (TAM/FAX mode)
- Use only as a fax (FAX ONLY mode)
- Use mostly as a telephone (TEL mode)
- Use as a telephone and/or fax (TEL/FAX mode)

4.5.1 Use as a telephone answering machine and/or fax (TAM/FAX mode)

Your situation

You want to answer phone calls using the telephone answering machine and receive faxes automatically.

Setup

Set the fax machine to TAM/FAX mode (page 34) by pressing **[AUTO ANSWER]** repeatedly.

- The **[AUTO ANSWER]** indicator on the base unit turns ON and **[☎]** (next to the battery icon) appears on the cordless handset display.

Note:

- Make sure feature #77 is set to “**TAM/FAX**” beforehand (page 46).
- Do not connect an answering machine to the same telephone line. If connected, set the automatic

answer feature to OFF by pressing **[AUTO ANSWER]** repeatedly.

How phone calls and faxes are received

If the call is a phone call, the fax machine will record the caller’s message automatically.

If a fax calling tone is detected, the fax machine will receive the fax automatically.

4.5.2 Use only as a fax (FAX ONLY mode)

Your situation

You have a separate telephone line just for faxes.

Setup

Set the fax machine to FAX ONLY mode (page 35) by pressing **[AUTO ANSWER]** repeatedly.

- The **[AUTO ANSWER]** indicator on the base unit turns ON and **[☎]** (next to the battery icon) appears on the cordless handset display.

Note:

- Make sure feature #77 is set to “**FAX ONLY**” beforehand (page 46).

How faxes are received

All incoming calls will be answered as faxes.

4.5.3 Use mostly as a telephone (TEL mode)

Your situation

You want to answer calls by yourself. If a fax call is received, you must receive the fax manually.

Setup

Set the fax machine to TEL mode (page 33) by pressing **[AUTO ANSWER]** repeatedly.

- The **[AUTO ANSWER]** indicator on the base unit turns OFF and **[☎]** (next to the battery icon) disappears from the cordless handset display.

Note:

- Make sure feature #73 is set to “**TEL**” beforehand (page 46).

How to receive phone calls and faxes

You have to answer all calls manually.

To receive a fax, press **[FAX START]**.

4.5.4 Use as a telephone and/or fax (TEL/FAX mode)

Your situation

You want to answer phone calls yourself and receive faxes automatically without rings.

Setup

Set the fax machine to TEL/FAX mode (page 33) by pressing **[AUTO ANSWER]** repeatedly.

- The **[AUTO ANSWER]** indicator on the base unit turns OFF and  (next to the battery icon) disappears from the cordless handset display.

Note:

- Make sure feature #73 is set to “**TEL/FAX**” beforehand (page 46).

How phone calls and faxes are received

If the call is a phone call, the fax machine will ring. If a fax calling tone is detected, the fax machine will receive the fax automatically without ringing.

4.6 Receiving a fax manually – Auto answer OFF

Note:

- By default, the unit reduces the size of the received document to 92% when printing (See feature #36 on page 44 for details).

4.6.1 Activating TEL mode

- 1 Make sure feature #73 is set to “**TEL**” beforehand (page 46).
- 2 Press **[AUTO ANSWER]** repeatedly to display “**TEL MODE**”.
 - The **[AUTO ANSWER]** indicator on the base unit turns OFF and  (next to the battery icon) disappears from the cordless handset display.

Activating TEL mode with the cordless handset

1. 
2. “**Answer System**” → **OK**
3. “**Answer Off**” → **OK** → **[*][#][9]**

Note:

- Make sure feature #73 is set to “**TEL**” beforehand (page 46).

How to receive phone calls and faxes with the base unit

KX-FC275:

1. Lift the handset or press **[SP-PHONE]** to answer the call.
2. When:
 - document reception is required,
 - a fax calling tone (slow beep) is heard, or
 - no sound is heard,
 press **[FAX START]**.
3. Replace the handset if using it.

KX-FC265:

1. Press **[SP-PHONE]** to answer the call.
2. When:
 - document reception is required,
 - a fax calling tone (slow beep) is heard, or

- no sound is heard, press **[FAX START]**.

How to receive calls and faxes with the cordless handset

1. Lift the cordless handset and press **[📞]** or **[📞]** to answer the call.
2. When:
 - document reception is required,
 - a fax calling tone (slow beep) is heard, or
 - no sound is heard,
 press .
3. Select “**Fax Start**”, then press **OK**.
 - You can also press **[FAX START]** on the base unit.

How to receive faxes with an extension telephone

If you have another telephone connected to the same line (extension telephone), you can use the extension telephone to receive faxes.

1. When the extension telephone rings, lift the handset of the extension telephone.
2. When:
 - document reception is required,
 - a fax calling tone (slow beep) is heard, or
 - no sound is heard,
 press **[*][#][9]** (default fax activation code) **firmly**.
3. Replace the handset.

Note:

- To receive fax documents using the extension telephone, you must set the remote fax activation to ON (feature #41 on page 45) beforehand. The default setting is ON.

To stop receiving

Press **[STOP]**.

4.6.2 Activating TEL/FAX mode

- 1 Make sure feature #73 is set to “**TEL/FAX**” beforehand (page 46).
- 2 Press **[AUTO ANSWER]** repeatedly to display “**TEL/FAX MODE**”.
 - The **[AUTO ANSWER]** indicator turns OFF and  (next to the battery icon) disappears from the cordless handset display.
- 3 The ringer volume setting should be ON (page 22).

Activating TEL/FAX mode with the cordless handset

1. 
2. “**Answer System**” → **OK**
3. “**Answer Off**” → **OK** → **[*][#][9]**

4. Fax

Note:

- Make sure feature #73 is set to “**TEL/FAX**” beforehand (page 46).

How phone calls and faxes are received

1. “**INCOMING CALL**” will be displayed but the unit will not ring.
2. The unit will wait for the duration of **2 rings** before answering the call.
 - The number of rings is determined by the “**TEL/FAX delayed ring count**” (feature #78 on page 46).
 - During this time, an extension telephone will ring.
3. The unit will answer the call and try to detect a fax calling tone.

When a fax calling tone is detected

The unit receives the fax automatically without ringing.

When a fax calling tone is not detected

- 1 The unit will ring. You may answer the call.
 - To answer the call, lift the handset (KX-FC275 only) or cordless handset and press **[↶]**, then talk to the other party.
 - To answer using another telephone connected to the same telephone line as this unit, lift the handset and press **[*][0]** (default auto disconnection code, feature #49 on page 45) to talk to the other party.

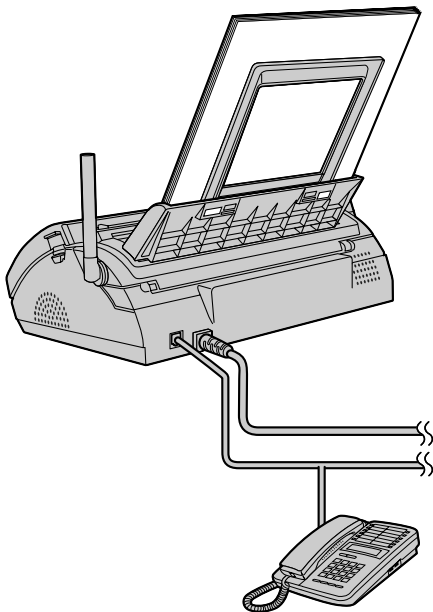

- Callers will hear a ring back tone different from the one generated by the telephone company.
- 2 If you do not answer the call, the unit will activate the fax function.
- Some fax machines do not generate fax calling tones when sending faxes, therefore the unit will

try to receive a fax even if no fax calling tone is detected.

Note:

- The auto disconnection code can be changed in feature #49 on page 45.

4.7 Receiving a fax automatically – Auto answer ON

Note:

- By default, the unit reduces the size of the received document to 92% when printing (See feature #36 on page 44 for details).

4.7.1 Activating TAM/FAX mode (Telephone Answering Machine/Fax mode)

- 1 Make sure feature #77 is set to “**TAM/FAX**” (page 46) beforehand.
- 2 Press **[AUTO ANSWER]** repeatedly to display “**TAM/FAX MODE**”.
 - The **[AUTO ANSWER]** indicator on the base unit turns ON and **[☑]** (next to the battery icon) appears on the cordless handset display.

Note:

- The maximum incoming message recording time can be changed (page 40, feature #10 on page 42).

Activating TAM/FAX mode with the cordless handset

1. **[☑]**
2. “**Answer System**” → **[OK]**
3. “**Answer On**” → **[OK]** → **[*][0]**

Note:

- When the answering machine is turned ON, **[☑]** is displayed next to the battery icon.
- Make sure feature #77 is set to “**TAM/FAX**” beforehand (page 46).

How phone calls and faxes are received

When receiving calls, the unit works as an answering machine and/or fax.

Note:

- If you answer a call with an extension telephone (if connected to the same line), and the answering machine is answering the call, you can press **[*][0]** (default auto disconnection code) to speak to the caller.
- The auto disconnection code can be changed in feature #49 on page 45.
- Even when you answer a call with the extension telephone, the answering machine may continue answering the call depending on the type of an extension telephone. Press **[STOP]** on the fax machine to talk with the calling party.

Receiving a voice message and fax document in one call

The caller can leave a voice message and send a fax document during the same call. Inform the caller of the following procedure beforehand.

1. The caller calls your unit.
 - The answering machine will answer the call.
2. The caller can leave a message after the greeting message.
3. The caller presses **[*][9]**.
 - The unit will activate the fax function.
4. The caller presses the start button to send a fax.

Changing the ring count in TAM/FAX mode

You can select from “2” (default), “3”, “4”, “5”, “6”, “7”, or “AUTO”. This setting can be changed by feature #06 on page 42, or using the cordless handset (page 40).

- “AUTO”: The unit answers after 2 or 3 rings when new messages have been recorded, and after 5 or 6 rings when there are no new messages. If you call your unit from a remote location to listen to new messages (page 40), you will know that there are no new messages when the unit rings for the 4th time. You can then hang up without being charged for the call.

4.7.2 Activating FAX ONLY mode

1. Make sure feature #77 is set to “FAX ONLY” (page 46) beforehand.
2. Press **[AUTO ANSWER]** repeatedly to display “FAX ONLY MODE”.
 - The **[AUTO ANSWER]** indicator on the base unit turns ON and **[L]** (next to the battery icon) appears on the cordless handset display.

Activating FAX ONLY mode with the cordless handset

1. **[☰]**
2. “Answer System” → **[OK]**
3. “Answer On” → **[OK]** → **[*][9]**

Note:

- Make sure feature #77 is set to “FAX ONLY” beforehand (page 46).

How faxes are received

When receiving calls, the unit will automatically answer all calls and only receive fax documents.

Note:

- The number of rings before a call is answered in FAX ONLY mode can be changed (feature #06 on page 42).

4.8 Receive polling (retrieving a fax placed on another fax machine)

This feature allows you to retrieve a document from another compatible fax machine. Therefore you pay for the call.

Make sure that no documents are fed into your unit and that the other party’s machine is ready for your call.

1. Press **[MENU]** repeatedly to display “POLLING”. → **[SET]**
2. Dial the fax number. → **[FAX START]**

4.9 Junk fax prohibitor (preventing fax reception from undesired callers)

If you subscribe to Caller ID service (page 27), this feature prevents fax reception from calls that do not show caller information.

Additionally, the fax machine will not accept faxes originated from numbers that match the ones on a programmable junk fax prohibitor list.

Important:

- This feature does not work when manual reception is performed.

4.9.1 Activating the junk fax prohibitor

1. Press **[MENU]** repeatedly to display “JUNK FAX PROH.”. → **[▶]**
2. Press **[+]** or **[–]** repeatedly to select “ON”. → **[SET]**
3. Press **[MENU]** to exit the program.

4.9.2 Storing undesired callers

You can register up to 10 undesired numbers from the Caller ID list (page 27) if you do not wish to receive faxes from them.

1. Press **[MENU]** repeatedly to display “JUNK FAX PROH.”.
2. Press **[▶]** repeatedly to display “JUNK LIST SET”. → **[SET]**
3. Press **[+]** or **[–]** repeatedly to display the item you wish to prevent the fax reception from. → **[SET]**
4. Press **[STOP]** to exit the program.

To display the junk fax prohibitor list

1. Press **[MENU]** repeatedly to display “JUNK FAX PROH.”.
2. Press **[▶]** repeatedly to display “JUNK LIST DISP.”. → **[SET]**

4. Fax

3. Press **[+]** or **[-]** to display the item.
4. Press **[MENU]** to exit the program.

To print the junk fax prohibitor list

1. Press **[MENU]** repeatedly to display “**JUNK FAX PROH.**”.
2. Press **[▶]** repeatedly to display “**JUNK LIST PRINT**”. → **[SET]**
3. Press **[MENU]** to exit.

To erase an item from the junk fax prohibitor list

1. Press **[MENU]** repeatedly to display “**JUNK FAX PROH.**”.
2. Press **[▶]** repeatedly to display “**JUNK LIST DISP.**”. → **[SET]**
3. Press **[+]** or **[-]** repeatedly to display the desired item. → **[ERASE]**
 - To cancel erasing, press **[STOP]**, then press **[MENU]**.
4. **[SET]** → **[MENU]**

5.1 Making a copy

- Adjust the width of the document guides to fit the actual size of the document.
- Insert the document (up to 10 pages) FACE DOWN until a single beep is heard and the unit grasps the document.
- If necessary, press **[+]** or **[-]** repeatedly to select the desired resolution.
 - If you select “**STANDARD**”, copying will be performed using “**FINE**” mode.
- [COPY]**
 - If necessary, enter the number of copies (up to 20).
- Press **[START]**, or the unit will start copying within 15 seconds.
 - The unit will start copying.

Note:

- Any document which can be sent as a fax can also be copied (page 30).

To select the resolution

Select the desired resolution according to the character size.

- “**FINE**”: For small-sized characters.
- “**SUPER FINE**”: For very small-sized characters.
- “**PHOTO**”: For photographs, shaded drawings, etc.

Copying from memory (Quick scan feature)

This feature is helpful when you want to copy the document, then remove it for other uses. To use this feature, activate feature #34 (page 44) beforehand. The default setting is OFF.

- If the document exceeds the memory capacity, copying of the exceeded document will be cancelled and this feature will be turned OFF automatically.

To stop copying

Press **[STOP]**.

5.1.1 More copying features

To enlarge a document

- Insert the document.
- [COPY]** → **[▶]**
- Press **[+]** repeatedly to select “150%” or “200%”. → **[START]**
 - The unit will enlarge the centre of the upper part of the document. To make an enlarged copy of the bottom of the document, turn the document around, and then make a copy.

Example: 150% enlarged copy

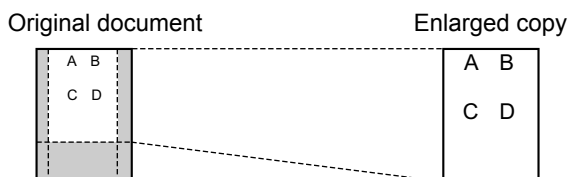

To reduce a document

- Insert the document.
- [COPY]** → **[▶]**
- Press **[-]** repeatedly to select “92%”, “86%” or “72%”, then press **[START]**.

Setting	Recording paper size	Original document size
“100%” (default)	A4	A4, Letter
“92%”	A4	A4
“86%”	A4	A4
“72%”	A4	Legal

Note:

- If the image at the bottom of the document is not copied when you copy a document that is the same length as the recording paper, try 92% or 86%.

To collate multiple copies

The unit can temporarily collate multiple copies in the same order as the original document pages.

- Insert the document.
- [COPY]**
- Enter the number of copies (up to 20).
- Press **[▶]** 2 times to display “**COLLATE OFF**”.
- Press **[+]** or **[-]** repeatedly to display “**COLLATE ON**”. → **[START]**

Example: Making 2 copies of a 4-page original document

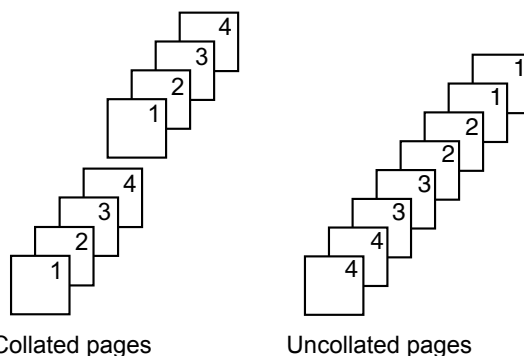

Note:

- The unit will store the documents into memory while collating the copies. If the memory becomes full while storing, the unit will only print out the stored pages.

6.1 Recording your greeting message

The unit has 2 pre-recorded greeting messages for TAM/FAX mode. If you record your own greeting message, it will be played instead of the pre-recorded greeting message when a call is received.

The maximum recording time of your greeting message is either 16 seconds (default) or 60 seconds. We recommend you record a message of less than 12 seconds to make it easier to receive faxes.

Make sure feature #77 is set to “**TAM/FAX**” beforehand (page 46).

Important:

- **When callers leave messages, the unit records the day and time of each message. Make sure the date and time have been set correctly (page 22).**

1 [GREETING REC]

- A long beep will sound.

2 Speak clearly about 20 cm away from [MIC].

3 When finished recording, press [STOP].

Note:

- You can change the maximum TAM/FAX greeting message time to 60 seconds (feature #54 on page 45).
 - If you change the setting to 60 seconds, we recommend that you tell the caller in your TAM/FAX greeting message to press ✕9 before starting the fax transmission.
 - If you change the setting from 60 seconds to 16 seconds, your current greeting message will be deleted. The pre-recorded greeting message will be played when a call is received.
- If you change the maximum recording time of incoming messages to “**GREETING ONLY**” (feature #10 on page 42), the unit will answer a call with your current greeting message, and then hang up. Re-record your greeting message to inform the caller that the unit will not record any incoming messages.

To check the greeting message

Press [GREETING CHECK].

- The unit will play the greeting message.

6.1.1 Erasing your recorded greeting message

1 [GREETING CHECK]

- To cancel erasing, press [STOP].

2 [ERASE]

Note:

- If you erase your TAM/FAX greeting message, the pre-recorded greeting message will be played when a call is received.

6.2 Listening to recorded messages

When the unit has recorded new voice messages:

- The [AUTO ANSWER] indicator will flash when auto answer is turned ON.
- The total number of recorded messages will flash on the base unit display.

6.2.1 To play back messages

Press [PLAYBACK].

- Only new messages will be played.
- After playing back all of the new messages, the [AUTO ANSWER] indicator will stop flashing but will remain lit up when auto answer is turned ON. If you press [PLAYBACK] at this time, all the recorded messages will be played.

6.2.2 Useful features during playback

To repeat a message

Press [◀] while listening to the message.

- If you press [◀] within 5 seconds of the beginning of the message, the previous message will be played.
- To play back a specific message, press [◀] or [▶] and search for the message you want to listen to.

To skip a message

Press [▶] to play the next message.

Voice time/day stamp

During playback, the unit will announce the day of the week and time that each message was recorded.

If you subscribe to Caller ID service

During playback, you can call back the displayed name or number using the base unit.

1. Press [MENU] during playback.
 - The base unit stops playback.
 - If you do not need to edit the telephone number, skip to step 3.
2. Edit the telephone number (page 28).
3. **KX-FC275:**
Lift the handset or press [SP-PHONE].

KX-FC265:
[SP-PHONE]

6.2.3 Erasing recorded messages

To erase a specific message

Press [ERASE] while listening to the message you want to erase.

To erase all messages

1. [ERASE]

2. Within 5 seconds, press **[ERASE]**.

6.3 Leaving a message for others or yourself

You can record a voice memo to leave a private message for yourself or someone else. Recorded messages are treated as new messages.

1 **[MEMO]**

- A long beep will sound.
- 2 Speak clearly about 20 cm away from **[MIC]**.
 - 3 To stop recording, press **[STOP]**.

Note:

- If you record for over 3 minutes, the unit will stop recording.

6.4 Using the answering machine with the cordless handset



Helpful hints:

- To activate TAM/FAX mode with the cordless handset, see page 34.

Important:

- When callers leave messages, the unit records the day and time of each message. Make sure the date and time have been set correctly (page 22).

6.4.1 Recording your greeting message

- 1 
- 2 "Answer System" → **OK**
- 3 "Greeting" → **OK**
- 4 "Start REC" → **OK**
- 5 "Yes" → **OK**
 - Hold the cordless handset about 20 cm away and speak clearly into the microphone.
- 6 Press  to stop recording. → **[↶⊙]**

To check the greeting message

1. 
2. "Answer System" → **OK**
3. "Greeting" → **OK**
4. "Play Greeting" → **OK** → **[↶⊙]**

To erase your greeting message

1. 
2. "Answer System" → **OK**
3. "Greeting" → **OK**
4. "Default" → **OK** 2 times
5. **[↶⊙]**

Using a pre-recorded greeting message

The unit provides 2 pre-recorded greeting messages:

- If you erase or do not record your own greeting message, the unit plays a pre-recorded greeting asking callers to leave a message.
- If the message recording time (page 40) is set to "Greeting Only", callers' messages are not recorded and the unit plays a different pre-recorded greeting message asking callers to call again.

6.4.2 Listening to recorded messages

When new messages have been recorded,  is displayed on the cordless handset with the total number of new messages.

- 1 
- 2 "Answer System" → **OK**
- 3 "Play New Msg." or "Play All Msg." → **OK**
- 4 When finished, press **[↶⊙]**.

Note:

- To switch to the receiver, press **[↶]**.
- If "Messages Full" is shown on the display,  and the total number of new messages are not displayed.

To repeat a message

Press **[1]** while listening to the message.

- If you press **[1]** within first 5 seconds of a message, the previous message is played.

To skip a message

Press **[2]** to play the next message.

To stop playback

Press .

If you subscribe to Caller ID service

If caller information is received for the call, you can call the caller back while listening to a message.

1. Press  during playback.
2. "Call Back" → **OK**

Note:

To edit the number before calling back:

1. Press  during playback.
2. "Edit & Call" → **OK**
3. Edit the number. → **[↶]**

6.4.3 Erasing recorded messages

To erase a specific message

Press **[✕][4]** while listening to the message you want to erase.

To erase all messages

1. 

6. Answering Machine

2. "Answer System" → **OK**
3. "Erase All Msg." → **OK**
4. "Yes" → **OK** → [**↶**⓪]

6.4.4 Direct command operation

You can operate the answering machine by pressing dial keys, rather than navigating through the menus. To use the following commands, press . → "Answer System" → **OK**

Key	Direct commands
[▲] or [▼]	Adjust the receiver or speaker volume (during playback)
[1]	Repeat message (during playback)* ¹
[2]	Skip message (during playback)
[3]	Enter the "Settings" menu
[4]	Play new messages
[5]	Play all messages
[6]	Play greeting message
[7][6]	Record greeting message
[8]	Turn auto answer setting ON
[9] or [■]	Stop recording/Stop playback
[0]	Turn auto answer setting OFF
[*][4]* ²	Erase currently playing message
[*][5]	Erase all messages
[*][6]	Erase greeting message* ³

*¹ If pressed within the first 5 seconds of a message, the previous message is played.

*² You can also erase as follows:

X → "Yes" → **OK**

*³ Unit resets to a pre-recorded greeting message.

6.4.5 Programming for answering machine

To set the remote operation ID

A 3-digit remote access code must be entered when operating the answering machine remotely. This code prevents unauthorised parties from listening to your messages remotely.

Important:

- In order to operate the answering machine remotely, you must first set a remote access code.

1. 
2. "Answer System" → **OK**
3. "Settings" → **OK**
4. "Remote Code" → **OK**
5. To turn ON remote operation, enter the desired 3-digit remote access code.
 - To turn OFF remote operation, press [*****].

6. **OK** → [**↶**⓪]

Note:

- You can also program this feature with the base unit (feature #11 on page 42).

To change the ring count in TAM/FAX mode

You can change the number of times the unit rings "Number of Rings" before the unit answers a call. You can select 2 to 7 rings, or "Auto".

The default setting is "2 Rings".

"Auto": The unit answers after 2 or 3 rings when new messages have been recorded, and after 5 or 6 rings when there are no new messages. If you call your unit from a remote location to listen to new messages (page 40), you will know that there are no new messages when the unit rings for the 4th time. You can then hang up without being charged for the call.

1. 
2. "Answer System" → **OK**
3. "Settings" → **OK**
4. "Number of Rings" → **OK**
5. Select the desired setting. → **OK** → [**↶**⓪]

Note:

- You can also program this feature with the base unit (feature #06 on page 42).

To change the maximum recording time for incoming messages

You can change the maximum message recording time allotted to each caller. You can also select "Greeting only" which sets the unit to greet callers but not record messages. The default setting is "3 Minutes".

1. 
2. "Answer System" → **OK**
3. "Settings" → **OK**
4. "Recording Time" → **OK**
5. Select the desired setting. → **OK** → [**↶**⓪]

Note:

- When you select "Greeting Only":
 - If you do not record your own message, the unit will play the pre-recorded greeting-only message asking callers to call again later.
 - If you use your own message, record the greeting-only message asking callers to call again later (page 39).
- You can also program this feature with the base unit (feature #10 on page 42).

6.5 Operating from a remote location

Using a touch-tone telephone, you can call your telephone number from outside and access the unit to listen to messages or change auto answer settings.

Important:

- Program the remote operation ID beforehand (page 40, feature #11 on page 42).
- Set the unit to TAM/FAX mode before going out (page 34).
- Use a touch tone telephone for remote operations.

6.5.1 Summary of remote operation

- 1 Call your unit.
- 2 Enter the remote operation ID during or after the TAM/FAX greeting message.
- 3 **When there are new recorded messages**
 1. A long beep will sound.
 2. Short beep(s) will sound up to 8 times.
 - This indicates the number of new messages.
 3. New messages will be played back.

When there are no new messages

1. A long beep will sound (short beep will not sound).
 2. Press **[5]**.
 3. All the recorded messages will be played back.
- 4 To end remote operation press **[9]**, then hang up.

6.5.2 Remote operation using remote commands

- 1 Call your unit.
- 2 Enter the remote operation ID during or after the TAM/FAX greeting message.
- 3 Enter a remote command within 10 seconds.

Note:

- When you press a key, press firmly.

Key	Remote command
[1]	Repeat message (during playback) ^{*1}
[2]	Skip message (during playback)
[4]	Play new messages
[5]	Play all messages
[6]	Play greeting message
[7]	Record greeting message
[9]	Stop current operation ^{*2}
[0]	Turn OFF auto answer setting
[*][4]	Erase currently playing message
[*][5]	Erase all messages
[*][6]	Erase greeting message (during greeting message playback) ^{*3}

Key	Remote command
[*][#]	End remote operation

- *1 If pressed within the first 5 seconds of a message, the previous message is played.
- *2 To resume operation, press a command key within 10 seconds.
- *3 Unit resets to a pre-recorded greeting message.

Recording a marker message

After playing back the messages, you can leave an additional message.

1. Wait for 3 beeps indicating the end of the remote operation.
2. Wait about 10 seconds.
3. Hear the voice guide and/or hear 1 beep.
4. Leave a message.

To turn ON the auto answer setting

1. Call your unit and let it ring 10 rings.
 - A beep will sound.
2. Enter the remote operation ID (page 40, feature #11 on page 42) within 10 seconds.
 - The receiving mode will be set to TAM/FAX or FAX ONLY mode, depending on the setting of feature #77 (page 46).
3. Hang up the handset.

Note:

- You cannot turn ON the auto answer setting when the unit is set to TEL/FAX mode.

7.1 Base unit programming

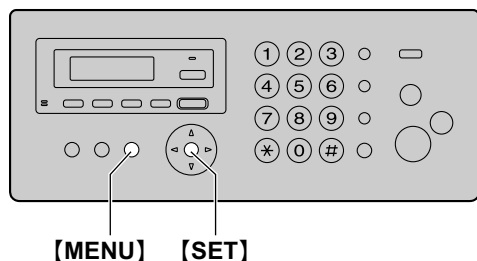

1. **[MENU]**
2. Press **[#]** and the 2-digit code (page 42 to page 46).
3. Press the desired command to display the desired setting.
 - This step may be slightly different depending on the feature.
4. **[SET]**
5. To exit programming, press **[MENU]**.

7.1.1 Basic features

Feature	Selection
Setting the date and time*¹ [#][0][1]	Enter the date and time using the dial keypad. See page 22 for details.
Setting your logo [#][0][2]	Enter your logo using the dial keypad. See page 22 for details.
Setting your fax number [#][0][3]	Enter your fax number using the dial keypad. See page 23 for details.
Printing a sending report [#][0][4]	<p>[0] "OFF": Sending reports will not be printed.</p> <p>[1] "ON": A sending report will be printed after every fax transmission.</p> <p>[2] "ERROR" (default): A sending report will be printed only when a fax transmission fails.</p>
Changing the ring count in FAX ONLY mode [#][0][6]	<p>[1] "1", [2] "2" (default), [3] "3", [4] "4", [5] "5", [6] "6", [7] "7", [8] "8", [9] "9"</p> <p>Note:</p> <ul style="list-style-type: none"> • Set feature #77 to "FAX ONLY" (page 46) beforehand.
Changing the ring count in TAM/FAX mode*¹ [#][0][6]	<p>[0] "AUTO", [2] "2" (default), [3] "3", [4] "4", [5] "5", [6] "6", [7] "7"</p> <p>See page 35 for details.</p> <p>Note:</p> <ul style="list-style-type: none"> • Set feature #77 to "TAM/FAX" (page 46) beforehand. • You can also program this feature with the cordless handset (page 40).
Changing the maximum recording time for incoming messages*¹ [#][1][0]	<p>[1] "1 MINUTE"</p> <p>[2] "GREETING ONLY": The unit plays the greeting message but does not record any incoming messages.</p> <p>[3] "3 MINUTES" (default)</p> <p>Note:</p> <ul style="list-style-type: none"> • You can also program this feature with the cordless handset (page 40).
Setting the remote operation ID*¹ [#][1][1]	<ol style="list-style-type: none"> 1. [MENU] → [#][1][1] 2. To activate the remote operation feature, enter a 3-digit remote operation ID. <ul style="list-style-type: none"> • To deactivate the remote operation feature, press [*]. 3. [SET] → [MENU] <p>Note:</p> <ul style="list-style-type: none"> • You can also program this feature with the cordless handset (page 40).

Feature	Selection
Setting the ringtone for outside calls* ² [#][1][7]	[1] "RINGTONE 1" (default) [2] "RINGTONE 2" [3] "RINGTONE 3" [4] "RINGTONE 4" [5] "RINGTONE 5" [6] "RINGTONE 6"

*1 When this setting is changed using the base unit, the setting for the cordless handset will also be changed, and vice versa.

*2 This setting can be changed individually for the base unit and the cordless handset.
– To set the cordless handset ringtone for outside calls, see page 47.

7.1.2 Advanced features

Feature	Selection
Setting the journal report to print automatically [#][2][2]	[0] "OFF": The unit will not print a journal report, but will keep a record of the last 30 fax transmissions and receptions. [1] "ON" (default): The unit will print a journal report automatically after every 30 new fax transmissions and receptions (page 30).
Sending documents overseas [#][2][3]	If you cannot send a fax overseas even if the number is correct and the line is connected, activate this feature before sending the fax. This feature improves the reliability by reducing the transmission speed. [0] "OFF": Deactivates this feature. [1] "NEXT FAX": This setting is effective only for the next attempted fax transmission. After transmission, the unit will return to the previous setting. [2] "ERROR" (default): When the previous fax transmission fails and you wish to re-send the document. Note: • Calling charges may be higher than usual.
Sending a fax at a specified time [#][2][5]	This feature allows you to take advantage of low-cost calling hours offered by your telephone company. This feature can be set up to 24 hours in advance of the desired time. [0] "OFF" (default) [1] "ON" To send a document: 1. Insert the document. 2. If necessary, press [+] or [-] repeatedly to select the desired resolution (page 30). 3. [MENU] → [#][2][5] 4. Press [1] to select "ON". → [SET] 5. Enter the fax number. → [SET] 6. Enter the transmission start time. • If you select 12-hour time entry (page 22), press [*] repeatedly to select AM or PM. • If you select 24-hour time entry (page 22), the time is set using 24-hour time entry. 7. [SET] → [MENU] Note: • To cancel after programming, press [STOP] then [SET] .

7. Programmable Features

Feature	Selection															
Setting the Caller ID list to print automatically 【#】【3】【6】	<p>[0] “OFF” (default): The Caller ID list will not be printed automatically, but the base unit will keep a record of the information for the last 50 callers.</p> <p>[1] “ON”: The Caller ID list will be printed automatically each time the base unit logs 50 callers (page 27).</p>															
Setting the time adjustment 【#】【3】【3】	<p>Using this feature, the unit’s date and time setting will be automatically adjusted when Caller information is received.</p> <p>[1] “AUTO” (default): The date and time setting will be automatically adjusted.</p> <p>[2] “MANUAL”: Deactivates this feature.</p>															
Setting the quick scan 【#】【3】【4】	<p>This feature is helpful when you want to remove the document for other uses, because the unit will release the document before sending or copying.</p> <p>[0] “OFF” (default): Deactivates this feature.</p> <p>[1] “ON”: The unit will scan the document and store it into memory first, then the unit will start sending or copying the documents.</p> <p>Note:</p> <ul style="list-style-type: none"> • If the document exceeds the memory capacity, sending of the whole document or copying of the exceeded document will be cancelled and this feature will be turned OFF automatically. 															
Receiving oversized documents 【#】【3】【6】	<p>If the size of the document sent by the other party is as large as or larger than the recording paper, the unit can reduce the document and print it. Select the desired reduction rate.</p> <p>[1] “72%”</p> <p>[2] “86%”</p> <p>[3] “92%” (default)</p> <p>[4] “100%”</p> <table border="1" data-bbox="491 956 1273 1180"> <thead> <tr> <th>Setting</th> <th>Recording paper size</th> <th>Original document size</th> </tr> </thead> <tbody> <tr> <td>“100%”</td> <td>A4</td> <td>Letter</td> </tr> <tr> <td>“92%” (default)</td> <td>A4</td> <td>A4</td> </tr> <tr> <td>“86%”</td> <td>A4</td> <td>A4</td> </tr> <tr> <td>“72%”</td> <td>A4</td> <td>Legal</td> </tr> </tbody> </table> <p>Note:</p> <ul style="list-style-type: none"> • The actual printing percentage may vary slightly depending on the type of recording paper, or other usage environment of the sending/receiving machines. • The information of the sending party is printed on the top of each page. Therefore, even if the original document is the same size as the recording paper, the document will be divided into 2 sheets when printed at “100%”. Select “92%” to print on 1 sheet. 	Setting	Recording paper size	Original document size	“100%”	A4	Letter	“92%” (default)	A4	A4	“86%”	A4	A4	“72%”	A4	Legal
Setting	Recording paper size	Original document size														
“100%”	A4	Letter														
“92%” (default)	A4	A4														
“86%”	A4	A4														
“72%”	A4	Legal														
Changing the LCD display contrast*1 【#】【3】【9】	<p>[1] “NORMAL” (default)</p> <p>[2] “DARKER”</p>															

Feature	Selection
Changing the fax activation code [#][4][1]	If you wish to use an extension telephone (page 33) to receive faxes, activate this feature and program the activation code. [0] "OFF" [1] "ON" (default) 1. [MENU] → [#][4][1] 2. Press [1] to select "ON". → [SET] 3. Enter your code from 2 to 4 digits, using 0-9, [*] and [#] . • The default code is *#9 . 4. [SET] → [MENU]
Setting the memory reception alert [#][4][4]	To alert you with a beeping sound when a received fax document is stored into memory due to some existing problem. [0] "OFF": Deactivates this feature. [1] "ON" (default): You will hear a beeping sound. Note: • The slow beeps will continue until you clear the printing problem and make sure the unit is supplied with enough paper to print the stored document.
Setting friendly reception [#][4][6]	To receive a fax automatically when you answer a call and hear a fax calling tone (slow beep). [0] "OFF": You have to press [FAX START] for fax reception. [1] "ON" (default): You do not have to press [FAX START] for fax reception.
Setting the auto disconnection [#][4][9]	To answer a call with an extension telephone in TEL/FAX mode (page 33), or TAM/FAX mode (page 34) activate this feature and program the code. [0] "OFF" [1] "ON" (default) 1. [MENU] → [#][4][9] 2. Press [1] to select "ON". → [SET] 3. Enter your code from 2 to 4 digits, using 0-9 and [*] . • The default code is *0 . 4. [SET] → [MENU]
Changing the greeting message time for TAM/FAX [#][5][4]	[1] "16s" (default): Maximum greeting message time is 16 seconds. [2] "60s": Maximum greeting message time is 60 seconds. See page 38 for details.
Setting the scan contrast [#][5][8]	To send or copy a document with faint or dark writing, set this feature before transmission or copying. [1] "NORMAL" (default): Used for normal writing. [2] "LIGHT": Used for dark writing. [3] "DARKER": Used for faint writing.
Copying phonebook data from the base unit to the cordless handset [#][5][9]	[1] "1 ITEM" (default) [2] "ALL ITEMS" See page 52 for details.
Screening the incoming call [#][6][7]	To hear an incoming call from the speaker when the answering machine is recording the message. [0] "OFF" [1] "ON" (default)

7. Programmable Features

Feature	Selection
Setting the Error Correction Mode (ECM) 【#】【6】【8】	<p>This feature is available when the transmitting/receiving fax machines are ECM compatible.</p> <p>【0】 “OFF”: Deactivates this feature.</p> <p>【1】 “ON” (default): If there is an error during fax transmission/reception, the unit will support the communication.</p> <p>Note:</p> <ul style="list-style-type: none"> You cannot change the setting when received documents are in memory.
Setting recall/flash time (for the base unit and cordless handset) 【#】【7】【2】	<p>The recall/flash time depends on your telephone exchange or host PBX.</p> <p>【1】 “900msec.”, 【2】 “700msec.”, 【3】 “600msec.”, 【4】 “400msec.”, 【5】 “300msec.”, 【6】 “250msec.”, 【7】 “200msec.”, 【8】 “160msec.”, 【9】 “110msec.”, 【*】 “100msec.” (default), 【0】 “90msec.”, 【#】 “80msec.”</p> <p>Note:</p> <ul style="list-style-type: none"> If the unit is connected via a PBX, this setting may need to be changed in order for PBX functions (transferring a call, etc.) to work correctly. Consult your PBX supplier for the correct setting.
Changing the receiving mode in the manual answer setting 【#】【7】【3】	<p>【1】 “TEL” (default): Telephone mode (page 33)</p> <p>【2】 “TEL/FAX”: Telephone/Fax mode (page 33)</p>
Setting the connecting tone 【#】【7】【6】	<p>If you often have trouble when sending faxes, this feature allows you to hear connecting tones: fax tone, ring back tone and busy tone. You can use those tones to confirm the status of the other party’s machine.</p> <p>【0】 “OFF”: Deactivates this feature.</p> <p>【1】 “ON” (default): You will hear connecting tones.</p> <p>Note:</p> <ul style="list-style-type: none"> If the ring back tone continues, the other party’s machine may not be a fax machine or may have run out of paper. Check with the other party. The connecting tone volume cannot be adjusted.
Changing the receiving mode in the auto answer setting 【#】【7】【7】	<p>【1】 “TAM/FAX” (default): Telephone Answering Machine/Fax mode (page 34)</p> <p>【2】 “FAX ONLY”: Fax only mode (page 35)</p>
Changing the TEL/FAX delayed ring count 【#】【7】【8】	<p>If you use an extension telephone when this unit is in TEL/FAX mode, select the desired number of times the extension telephone rings before the unit answers the call.</p> <p>【1】 “1”, 【2】 “2” (default), 【3】 “3”, 【4】 “4”, 【5】 “5”, 【6】 “6”, 【7】 “7”, 【8】 “8”, 【9】 “9”</p> <p>See page 34 for details.</p>
Resetting advanced features to their default settings 【#】【8】【0】	<p>【0】 “NO” (default)</p> <p>【1】 “YES”</p> <p>To reset the advanced features:</p> <ol style="list-style-type: none"> 【MENU】 → 【#】【8】【0】 Press 【1】 to select “YES”. → 【SET】 → 【SET】 <p>Note:</p> <ul style="list-style-type: none"> The ECM selection (feature #68 on page 46) will not be reset.

- *1 This setting can be changed individually for the base unit and the cordless handset.
- To set the cordless handset LCD display contrast, see page 47.

7.2 Cordless handset programming

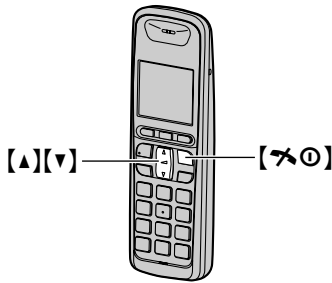

- 1.
2. Press [▼] or [▲] to select the desired top-menu. → **OK**
3. Press [▼] or [▲] to select the desired item in sub-menu 1. → **OK**
 - In some cases, you may need to select from sub-menu 2. → **OK**
4. Press [▼] or [▲] to select the desired setting. → **OK**
 - This step may vary depending on the feature being programmed.
 - To exit the operation, press [↶].

Note:

- For other top-menus, please refer to each chapter.
- The current item or setting is highlighted on the display.

7.2.1 Cordless handset features

Top-menu	Sub-menu 1	Sub-menu 2	Feature (default setting)
"Handset Setup"	"Time Settings"	"Set Date/Time"*1	Date and time: page 22
		"Alarm"	Set the alarm: page 49
	"Ringer Setup"	"Ringer Volume"*2, *3	Cordless handset ringer volume (<i>Maximum</i>): page 21
		"Ringtone"*2, *4, *5	Ringtones for outside calls ("Ringtone 1")
	"Display Setup"*2	"Language"	Display language ("English"): page 49
		"Contrast"	LCD display contrast (<i>Level 3</i>)
	"Register H.set"	–	page 50
"Keytones"*6	–	Keytones ON/OFF ("On")	
"Auto Talk"	–	Auto talk ON/OFF ("Off"): page 25	
"Base Unit Setup"	"Base Unit PIN"	–	Change base unit PIN ("000").*7 Enter the current 4-digit base unit PIN.*8 → Enter the new 4-digit base unit PIN. → OK
	"Repeater"	–	("Off") page 50

7. Programmable Features

- *1 When this setting is changed using the cordless handset, the setting for the base unit will also be changed, and vice versa.
- *2 This setting can be changed individually for the base unit and the cordless handset.
 - To set the base unit ringer volume, see page 22.
 - To set the base unit ringtone for outside calls, see feature #17 on page 43.
 - To set the base unit LCD display contrast, see feature #39 on page 44.
- *3 When the ringer volume is turned OFF, M is displayed and the cordless handset does not ring for outside calls. However even when the ringer volume is set to OFF, the cordless handset rings:
 - at the low level for alarm (page 49) and intercom calls (page 51)
 - at the high level for paging (page 51)
- *4 If you select one of the melody ringer tones, the ringer tone continues to play for several seconds even if the caller has already hung up. You may either hear a dial tone or no one on the line when you answer the call.
- *5 The preset melodies in this product are used with permission of © 2007 Copyrights Vision Inc.
- *6 Turn this feature OFF if you prefer not to hear key tones while you are dialling or pressing any keys, including confirmation tones and error tones.
- *7 If you change the PIN, please make note of your new PIN. The unit will not reveal the PIN to you.
- *8 If you forget your PIN, consult your nearest Panasonic service centre.

7.2.2 Cordless handset setup

[**v**] 2 times, press **OK** 2 times, select the desired language, then press **OK**. Press [**⌂**].

Alarm

You can set one of 2 different alarm options (once or daily) at a time for each cordless handset. An alarm sounds at the set time for 3 minutes.

Important:

- **Set the date and time beforehand (page 22).**

1. [**☰**]
2. "Handset Setup" → **OK**
3. "Time Settings" → **OK**
4. "Alarm" → **OK**
5. Select the desired alarm option. → **OK**

<p>"Off" Turns alarm OFF. Press OK again, then press [⌂] to exit.</p>
<p>"Once" An alarm sounds once at the set time. Enter the desired date and month. → OK</p>
<p>"Daily" An alarm sounds daily at the set time.</p>

6. Set the desired time. → **OK**
7. Select the desired alarm tone. → **OK** 2 times
 - We recommend selecting a different ringer tone to the one used for outside calls.
8. [**⌂**]
 - When the alarm is set, ☉ is displayed.

Note:

- You can skip to step 4 by pressing [**R/☉**] in standby mode.
- To stop the alarm, press any dial key or place the cordless handset on the base unit or charger.
- When the cordless handset is in use, the alarm will not sound until the cordless handset is in standby mode.
- If you select "once", the setting changes to "off" after the alarm sounds.

Display language

Important:

- **When the language selection is displayed after installing the batteries for the first time, perform step 5.**

1. [**☰**]
2. "Handset Setup" → **OK**
3. "Display Setup" → **OK**
4. "Language" → **OK**
5. Select your desired language. → **OK** → [**⌂**]

Note:

- If you select a language you cannot read, press [**⌂**], [**☰**], press [**▲**] 3 times, press **OK**, press

8.1 Operating additional units

8.1.1 Additional cordless handsets

Up to 6 cordless handsets can be registered to a single base unit. Additional cordless handsets will give you the freedom to, for example, have an intercom call with another cordless handset while a third cordless handset is on an outside call.

Important:

- **The additional cordless handset model recommended for use with this unit is noted on page 11. If another cordless handset model is used, certain operations (cordless handset settings, base unit settings, etc.) may not be available.**

8.2 Registering a cordless handset to a base unit

The supplied cordless handset and base unit are pre-registered. If for some reason the cordless handset is not registered to the base unit (for example, ∇ flashes even when the cordless handset is near the base unit), re-register the cordless handset.

After purchasing an additional cordless handset, register it to the base unit. Ensure that the additional cordless handset is switched ON. If it is not ON, press and hold [🔌] for few seconds to turn the cordless handset ON.

- 1 [☰]
- 2 “Handset Setup” → **OK**
- 3 “Register H.set” → **OK**
- 4 Press and hold [LOCATOR] on the base unit for about 3 seconds, until the registration tone sounds.
 - After pressing [LOCATOR], the rest of this procedure must be completed within 1 minute.
- 5 Wait until “Base PIN” is displayed, then enter the base unit PIN (default: “0000”), then press **OK**.
 - If you forget your PIN, consult your nearest Panasonic service centre.
 - When the cordless handset has been registered successfully, ∇ will stop flashing. If keytones are turned ON (page 47), a confirmation tone will be heard.

Note:

- Charge the batteries of your additional cordless handset for about 7 hours before initial use.
- When you purchase an additional cordless handset, refer to the additional cordless handset’s installation manual for registration.

8.2.1 Deregistering a cordless handset

A cordless handset can cancel its own registration (or the registration of another cordless handset) that is stored to

the base unit. This allows the cordless handset to end its wireless connection with the system.

- 1 [☰]
- 2 “Base Unit Setup” → **OK**
- 3 [3][3][5]
- 4 “Cancel Register” → **OK**
 - The numbers of all cordless handsets registered to the base unit are displayed.
- 5 Select the cordless handset(s) you want to cancel, by pressing the desired cordless handset number. → **OK**
 - The selected cordless handset number(s) flashes.
 - To cancel a selected cordless handset number, press the number again. The number stops flashing.
- 6 “Yes” → **OK**
 - A confirmation tone sounds as each cordless handset number disappears.
 - The cordless handset does not beep when cancelling its own registration.
- 7 [🔌]

8.2.2 Increasing the range of the base unit

You can increase the signal range of the base unit by using a DECT repeater. Please use only Panasonic DECT repeater. See page 11 for accessory information. Contact your Panasonic retailer/dealer for details.

Important:

- **Before registering the repeater to this base unit, you must turn the repeater mode ON.**
- **Do not use more than one repeater at a time.**

Setting the repeater mode

1. [☰]
2. “Base Unit Setup” → **OK**
3. “Repeater” → **OK**
4. “On” or “Off” → **OK** → [🔌]

Note:

- After turning repeater mode ON or OFF, ∇ flashes on the cordless handset momentarily. This is normal and the cordless handset can be used once ∇ stops flashing.



8.3 Intercom

Intercom calls can be made between a cordless handset and the base unit, and between 2 cordless handsets. You can page all cordless handsets at once from the base unit.

Note:

- If you receive an outside call while talking on the intercom, you hear interrupt tones. To answer the call, hang up the intercom, then answer the outside call.
 - see step 3 on “3.1.1 With the cordless handset”, page 24.
 - see step 3 on “3.1.2 With the base unit”, page 24.
- **[RECALL] / [R/⊕]** cannot be used to answer outside calls.
- When paging the cordless handset, the paged cordless handset beeps for 1 minute.

8.3.1 Making intercom calls**With the cordless handset**

- 1  → 
- 2 **To page the base unit**, press **[0]**.
To page another cordless handset, press the desired cordless handset number.
 - The base unit or the destination cordless handset will beep (be paged) for 1 minute.
 - To stop paging, press **[*0]**.
- 3 When the paged party answers, talk into the cordless handset.
- 4 To end the intercom call, press **[*0]**.

With the base unit

- 1 **[INTERCOM]**
- 2 **To page one cordless handset**, press the desired cordless handset number.
To page all cordless handsets, press **[0]**.
 - The destination cordless handset(s) will beep (be paged) for 1 minute.
 - To stop paging, press **[SP-PHONE]** or **[INTERCOM]**.
- 3 When the paged party answers, talk into **[MIC]**.
- 4 To end the intercom call, press **[SP-PHONE]** or **[INTERCOM]**.

Cordless handset locator

You can locate a misplaced cordless handset by pressing **[LOCATOR][0]** on the base unit.

- All registered cordless handsets beep for 1 minute. To stop paging, press **[LOCATOR]** again.

8.3.2 Answering intercom calls**With the cordless handset**

When the cordless handset is being paged, it will beep (be paged) and the ringer indicator will flash rapidly. The display will show the paging extension's number.

- 1 Press **[hook]** or **[hook]** to answer the page.
- 2 To end the intercom call, press **[*0]**.

With the base unit

When the base unit is being paged, it will beep and display the paging extension's number.

KX-FC275:

- 1 Press **[SP-PHONE]**, **[INTERCOM]** or lift the handset to answer the page.
- 2 To end the intercom call, press **[SP-PHONE]**, **[INTERCOM]** or replace the handset.

KX-FC265:

- 1 Press **[SP-PHONE]** or **[INTERCOM]** to answer the page.
- 2 To end the intercom call, press **[SP-PHONE]** or **[INTERCOM]**.

8.4 Transferring a call/conference

Outside calls can be transferred between a cordless handset and the base unit, and between 2 cordless handsets using the intercom feature.

8.4.1 To the base unit or another cordless handset (using the cordless handset)**1 Cordless handset:**

During an outside call, press  to put the call on hold.

-  flashes to indicate the outside call is on hold.

2 Cordless handset:

To page the base unit, press **[0]**.

To page another cordless handset, press the desired cordless handset number.

3 Base unit (KX-FC275):

Press **[SP-PHONE]** or lift the handset to answer the page.

Base unit (KX-FC265):

Press **[SP-PHONE]** to answer the page.

Another cordless handset:

Press **[hook]** or **[hook]** to answer the page.

4 Cordless handset:

To complete the transfer, press **[*0]**.

To establish a conference call, press **[3]**.

- To leave the conference, press **[*0]**. The other parties can continue the conversation.

Note:

- After the paging party disconnects, you can talk to the outside caller.

Transferring a call without speaking to the base unit user/other cordless handset user

After step 2, press **[*0]**.

- The outside call rings at the base unit or the other cordless handset.

8. Multi-unit Operation

Note:

- If the transferred call is not answered within 60 seconds, the call will ring at your cordless handset again. Press **[↶]** or **[↷]** to return to the outside call.

8.4.2 To a cordless handset (using the base unit)

1 Base unit:

During a telephone call, press **[INTERCOM]**.

- The call will be put on hold.

2 Base unit:

To page one cordless handset, press the desired cordless handset number.

To page all cordless handsets, press **[0]**.

3 Cordless handset:

Press **[↶]** or **[↷]** to answer the page.

4 Base unit (KX-FC275):

To complete the transfer, press **[SP-PHONE]** or replace the handset.

To establish a conference call, press **[3]**.

Base unit (KX-FC265):

To complete the transfer, press **[SP-PHONE]**.

To establish a conference call, press **[3]**.

Transferring a call without speaking to the cordless handset user

KX-FC275:

After step 2, press **[SP-PHONE]** or replace the handset.

- The outside call rings at the cordless handset(s).

KX-FC265:

After step 2, press **[SP-PHONE]**.

- The outside call rings at the cordless handset(s).

Note:

- If the transferred call is not answered within 60 seconds, the call will ring at the base unit again. Press **[SP-PHONE]** or lift the handset (KX-FC275 only) to return to the outside call.

8.5 Copying phonebook items

One or all phonebook items can be copied between a cordless handset and the base unit or between 2 cordless handsets. The destination unit will save the items in its phonebook.

8.5.1 To the base unit or another cordless handset (using the cordless handset)

Copying one phonebook item

1. Find the desired cordless handset phonebook item (page 25). → 
2. "Copy" → **OK**



3. To copy to the base unit, press **[0]**.

To copy to another cordless handset, enter the desired cordless handset number you wish to send the cordless handset phonebook item to.

- When an item has been copied, "Completed" is displayed.
- To continue copying another item: "Yes" → **OK** → Find the desired cordless handset phonebook item. → **OK**

4. 

Copying all the phonebook items

1.  → 

2. "Copy All" → **OK**

3. To copy to the base unit, press **[0]**.

To copy to another cordless handset, enter the desired cordless handset number you wish to send the cordless handset phonebook item to.

- When all items have been copied, "Completed" is displayed.

4. 

8.5.2 To the cordless handset (using the base unit)

Copying one phonebook item

1. **[MENU]** → **[#][5][9]**

2. Press **[1]** to display "1 ITEM". → **[SET]**

3. Enter the cordless handset number you wish to send the item to.

4. Press **[+]** or **[-]** repeatedly to display the desired item.

5. **[SET]**

- To copy another item, repeat steps 4 and 5.

6. After copying is completed, press **[MENU]**.

Copying all the phonebook items

1. **[MENU]** → **[#][5][9]**

2. Press **[2]** to display "ALL ITEMS". → **[SET]**

3. Enter the cordless handset number you wish to send the item to.

4. After copying is completed, press **[MENU]**.

9.1 Character entry

The dial keys are used to enter characters and numbers. Each dial key has multiple characters assigned to it. The available character entry modes are Alphabet (ABC), Numeric (0-9), Greek (ABΓ), Extended 1 (AĀĀ), Extended 2 (SŠŠ) and Cyrillic (АБВ). When in these entry modes except Numeric, you can select which character is entered by pressing a dial key repeatedly.

- Press [◀] or [▶] of the base unit and [▲] or [▼] of the cordless handset to move the cursor left or right.
- Press the dial keys to enter characters and numbers.
- Press [STOP] on the base unit or [C] on the cordless handset to erase the character or number highlighted by the cursor. Press and hold [STOP]/ [C] to erase all characters or numbers.
- Press [*] to switch between uppercase and lowercase.
- To enter another character located on the same dial key, press [▶] of the base unit and [▼] of the cordless handset to move the cursor to the next space, then press the appropriate dial key.
- If you do not press any dial key of the cordless handset within 5 seconds after entering a character, the character is fixed and the cursor moves to the right.

9.1.1 Character entry modes

Several character entry modes can be used when entering text. The characters that can be entered depend on the entry mode.

9.1.2 Characters available in each character entry mode

When the base unit displays the character entry screen:

Press [H] repeatedly to select a character entry mode.

When the cordless handset displays the character entry screen:

[1/2/3] → Select a character entry mode. → [OK]

Alphabet character table (ABC)

[0]	[1]	[2]	[3]	[4]	[5]	[6]	[7]	[8]	[9]
Space 0	Space # & ' () * , - . / 1	A B C 2	D E F 3	G H I 4	J K L 5	M N O 6	P Q R S 7	T U V 8	W X Y Z 9
		a b c 2	d e f 3	g h i 4	j k l 5	m n o 6	p q r s 7	t u v 8	w x y z 9

Numeric entry table (0-9)

[0]	[1]	[2]	[3]	[4]	[5]	[6]	[7]	[8]	[9]
0	1	2	3	4	5	6	7	8	9

Greek character table (ABΓ)

[0]	[1]	[2]	[3]	[4]	[5]	[6]	[7]	[8]	[9]
Space 0	Space # & ' () * , - . / 1	A B Γ 2	Δ E Z 3	H Θ I 4	K Λ M 5	N Ξ O 6	Π P Σ 7	T Y Φ 8	X Ψ Ω Ξ 9

9. Useful Information

Extended 1 character table (AÄÄ)

[0]	[1]	[2]	[3]	[4]	[5]	[6]	[7]	[8]	[9]
Space 0	Space # & ' () * , - . / 1	A À Á Â Ã Ä Å Æ B C Ç 2	D Ę Ě É Ê Ë Ĕ ĕ Ė F 3	G Ğ H I Ĩ Í Ĵ ĵ 4	J K L 5	M N Ñ O Õ Ó Ö Ō Ö ø 6	P Q R S Ş ß 7	T U Û Ú Ü Û Ü V 8	W Ŵ X Y ŷ Z 9
		a à á â ã ä å æ b c ç 2	d e è é ê ë ë f 3	g ğ h i ĩ í ĵ 4	j k l 5	m n ñ o ò ó ö õ ö ø 6	p q r s ş ß 7	t u ù ú û ü ü v 8	w ŵ x y ŷ z 9

- The following are used for both uppercase and lowercase: ø Ş ß Ŵ ŷ

Extended 2 character table (ššš)

[0]	[1]	[2]	[3]	[4]	[5]	[6]	[7]	[8]	[9]
Space 0	Space # & ' () * , - . / 1	A Ā Ą Ą B C Ć Ć 2	D Ę Ę É Ę Ę F 3	G H I Í 4	J K L Ł Ł Ł 5	M N Ń Ń Ń Ń Ō Ō 6	P Q R Ŕ Ŕ Ŕ Ŕ Ŗ Ŗ 7	T Ŧ U Ú Ŧ Ŧ ú v 8	W X Y ŷ Ź Ź Ź Ż 9
		a ā ą ą b c ć ć 2	d ę ę é ę ę f 3	g h i í 4	j k l ł ł ł 5	m n ń ń ń ń ō ō 6	p q r ŕ ŕ ŕ ŕ ŗ ŗ 7	t ŧ u ú ú ŧ ŧ ú v 8	w x y ŷ ź ź ź ż 9

- The following are used for both uppercase and lowercase:

Ą Ć Ć Ę Ł Ł Ł Ń Ŕ Ŕ Ŕ Ŗ ŷ Ź Ź Ź Ż

Cyrillic character table (АБВ)

[0]	[1]	[2]	[3]	[4]	[5]	[6]	[7]	[8]	[9]
Space 0 Ё Ё І Ї ŷ	Space # & ' () * , - . / 1	А Б В Г 2	Д Е Ж З 3	И Й К Л 4	М Н О П 5	Р С Т У 6	Ф Х Ц Ч 7	Ш Щ Ъ Ъ 8	Ь Э Ю Я 9

10.1 Report messages

To indicate the unit's fax transmission/reception status, one of the following messages will be printed on the sending and journal reports (page 30).

Message	Code	Cause & Solution
COMMUNICATION ERROR	40-42 46-72 FF	<ul style="list-style-type: none"> A transmission or reception error occurred. Try again or check with the other party.
	43 44	<ul style="list-style-type: none"> A line problem occurred. Connect the telephone line cord to a different jack and try again. An overseas transmission error occurred. Try using the overseas mode (feature #23 on page 43).
DOCUMENT JAMMED	----	<ul style="list-style-type: none"> Remove the jammed document (page 65).
ERROR-NOT YOUR UNIT	53 54 59 70	<ul style="list-style-type: none"> A transmission or reception error occurred because of a problem with the other party's fax machine. Check with the other party.
JUNK FAX PROH. REJECT	----	<ul style="list-style-type: none"> The junk fax prohibitor feature of this unit rejected fax reception.
MEMORY FULL	----	<ul style="list-style-type: none"> The memory is full of received documents due to a lack of recording paper, a lack of ink film or a recording paper jam. Install paper (page 17), install ink film (page 15) or remove the jammed paper (page 64).
NO DOCUMENT	----	<ul style="list-style-type: none"> The document was not fed into the unit properly. Re-insert the document and try again.
OTHER FAX NOT RESPONDING	----	<ul style="list-style-type: none"> The other party's fax machine is busy or has run out of recording paper. Try again. The other party's fax machine rang too many times. Send the fax manually (page 30). The other party's machine is not a fax machine. Check with the other party. The number you dialed is not in service.
PRESSED THE STOP KEY	----	<ul style="list-style-type: none"> [STOP] was pressed, and fax transmission or reception was cancelled.
OK	----	<ul style="list-style-type: none"> Fax transmission or reception was successful.

10.2 Display messages

To indicate the unit's status, one or more of the following messages will appear on the display.

10.2.1 Base unit

Display	Cause & Solution
"BACK COVER OPEN"	<ul style="list-style-type: none"> The back cover is open. Close the back cover firmly.
"BUSY"	<ul style="list-style-type: none"> The cordless handset you tried to call is in use. The cordless handset you are calling is too far from the base unit.
"CALL SERVICE"	<ul style="list-style-type: none"> There is something wrong with the unit. Contact our service personnel.

Display	Cause & Solution
"CHECK DOCUMENT"	<ul style="list-style-type: none"> • The document was not fed into the unit properly. Re-insert the document. If misfeeding occurs frequently, clean the document feeder rollers (page 65) and try again. • The document is longer than 600 mm. Press [STOP] to remove the document. Divide the document into two or more sheets, and try again.
"CHECK FILM"	<ul style="list-style-type: none"> • The ink film is empty. Replace the ink film with a new one (page 15). • The ink film is not installed. Install it (page 15). • The ink film is slack or creased. Tighten it (see step 5 on page 16).
"CHECK PAPER"	<ul style="list-style-type: none"> • The recording paper is not installed or the unit has run out of paper. Install paper and press [SET] to clear the message. • The recording paper was not fed into the unit properly (page 65). Re-install paper (page 17) and press [SET] to clear the message. • The recording paper has jammed near the recording paper entrance. Remove the jammed paper (page 64) and press [SET] to clear the message.
"FAX IN MEMORY"	<ul style="list-style-type: none"> • See the other displayed message instructions to print out the document. Received documents are stored in memory due to a lack of recording paper, a lack of ink film or a recording paper jam. Install paper (page 17), install ink film (page 15) or remove the jammed paper (page 64). You will lose all faxes in memory if the power is removed. Check with power connected.
"FAX MEMORY FULL"	<ul style="list-style-type: none"> • The memory is full of received documents due to a lack of recording paper, a lack of ink film or a recording paper jam. Install paper (page 17), install ink film (page 15) or remove the jammed paper (page 64). You will lose all faxes in memory if the power is removed. Check with power connected. • When performing memory transmission, the document being stored exceeded the memory capacity of the unit. Send the entire document manually.
"FILM EMPTY"	<ul style="list-style-type: none"> • The ink film is empty. Replace the ink film with a new one (page 15). • The ink film is slack. Tighten it (see step 5 on page 16) and install again. • The fax machine is positioned near appliances such as TVs or speakers which generate an intense magnetic field.
"FILM NEAR EMPTY"	<ul style="list-style-type: none"> • The remaining ink film is low. Prepare a new ink film (page 11).
"MEMORY FULL"	<ul style="list-style-type: none"> • The base unit's phonebook memory is full. Erase unnecessary items (page 26). • When making a copy, the document being stored exceeded the memory capacity of the unit. Press [STOP] to clear the message. Divide the document into sections.
"MESSAGE FULL"	<ul style="list-style-type: none"> • There is no room left in the memory to record voice messages. Erase unnecessary messages (page 38, 39).
"MODEM ERROR"	<ul style="list-style-type: none"> • There is something wrong with the unit's modem. Contact our service personnel.
"NO FAX REPLY"	<ul style="list-style-type: none"> • The other party's fax machine is busy or has run out of recording paper. Try again.
"OPEN CABINET CHECK FILM SLACK" "OPEN CABINET CHECK FILM TYPE"	<ul style="list-style-type: none"> • Please use genuine Panasonic replacement film (page 11). • The ink film is slack. Tighten it (see step 5 on page 16). • The fax machine is positioned near appliances such as TVs or speakers which generate an intense magnetic field.
"PAPER JAMMED"	<ul style="list-style-type: none"> • A recording paper jam occurred. Remove the jammed paper (page 64). • You forced the recording paper into the paper tray too strongly. Remove all of the installed paper, and re-install it gently.
"PLEASE WAIT"	<ul style="list-style-type: none"> • The unit is checking that there is no slack or crease in the ink film. Wait for a moment while the check is completed.

Display	Cause & Solution
"POLLING ERROR"	<ul style="list-style-type: none"> The other party's fax machine does not support polling. Check with the other party.
"RECORDING ERROR"	<ul style="list-style-type: none"> The greeting message you recorded was under 1 second long. Record a longer message.
"REDIAL TIME OUT"	<ul style="list-style-type: none"> The other party's fax machine is busy or has run out of recording paper. Try again.
"REMOVE DOCUMENT"	<ul style="list-style-type: none"> The document is jammed. Remove the jammed document (page 65). Press [STOP] to eject the jammed paper.
"SERIAL ERROR"	<ul style="list-style-type: none"> There is something wrong with the unit. Contact our service personnel.
"TRANSMIT ERROR"	<ul style="list-style-type: none"> A transmission error occurred. Try again. If you send a fax overseas, try the following: <ul style="list-style-type: none"> Use the overseas transmission mode (feature #23 on page 43). Add 2 pauses at the end of the telephone number or dial manually.
"UNIT OVERHEATED"	<ul style="list-style-type: none"> The unit is too hot. Stop using the unit for a while and let the unit cool down.

10.2.2 Cordless handset

Display	Cause & Solution
"Error"	<ul style="list-style-type: none"> Recording was too short. Try again.
"Failed"	<ul style="list-style-type: none"> Phonebook copy failed. Confirm the destination unit is in standby mode and try again.
"Incomplete"	<ul style="list-style-type: none"> The destination unit's phonebook memory is full. Erase the unnecessary phonebook items from the destination unit and try again.
"Memory Full"	<ul style="list-style-type: none"> The cordless handset's phonebook memory is full. Erase unnecessary items (page 25).
"Messages Full"	<ul style="list-style-type: none"> There is no room left in the memory to record voice messages. Erase unnecessary messages (page 38, 39).
"No link. Reconnect AC adaptor."	<ul style="list-style-type: none"> The cordless handset has lost communication with the base unit. Move closer to the base unit and try again. Unplug the base unit's mains lead to reset the unit. Reconnect the mains lead and try again. The cordless handset's registration may have been cancelled. Re-register the cordless handset (page 50).
"Use rechargeable battery."	<ul style="list-style-type: none"> A wrong type of battery such as Alkaline or Manganese was inserted. Use only the rechargeable Ni-MH battery noted on page 5, 11.
"You must first subscribe to Caller ID."	<ul style="list-style-type: none"> You must subscribe to use Caller ID service. Once you receive caller information after subscribing to a Caller ID service, this message will not be displayed.
"Press [•••] 5sec on base, then put on charger"	<ul style="list-style-type: none"> The cordless handset is not registered to the base unit. Press [LOCATOR] (•••) on the base unit for about 5 seconds, then place the cordless handset on the base unit or charger. The cordless handset will be registered to the base unit.

10.3 When a function does not work

If you still have difficulties after following the instructions in this section, reset the unit. Disconnect the mains lead and turn OFF the cordless handset. Reconnect the mains lead and turn ON the cordless handset.

10.3.1 Initial settings

Problem	Cause & Solution
I cannot hear a dial tone.	<ul style="list-style-type: none"> • If you used a splitter/coupler to connect the unit, remove the splitter/coupler and connect the unit to the wall jack directly. If the unit operates properly, check the splitter/coupler. • Disconnect the unit from the telephone line and connect a known working telephone. If the working telephone operates properly, contact our service personnel to have the unit repaired. If the working telephone does not operate properly, contact your telephone company. • The mains lead or telephone line cord is not connected. Check the connections. • If you have connected the fax machine through a computer modem, connect the fax machine directly to a telephone line jack.
The unit does not work.	<ul style="list-style-type: none"> • Check the connections (page 20). • Make sure that the cordless handset's battery is installed correctly (page 18) and fully charge it (page 21).
The unit does not ring.	<ul style="list-style-type: none"> • The ringer volume is turned OFF. Adjust it (page 21).
I cannot make calls.	<ul style="list-style-type: none"> • The cordless handset is too far from the base unit. Move closer and try again.

10.3.2 General



Problem	Cause & Solution
The unit displays "PAPER JAMMED" even though paper is installed.	<ul style="list-style-type: none"> • You forced the recording paper into the paper tray too strongly. Remove all of the installed paper, and re-install it gently.
The unit displays "CHECK PAPER" even though paper is inserted.	<ul style="list-style-type: none"> • The paper is inserted halfway. Insert it correctly (page 65) and press [SET] to clear the message.
The other party complains they only hear a fax tone and cannot talk.	<ul style="list-style-type: none"> • FAX ONLY mode is set. Tell the other party the number is only used for faxes. • Change the receiving mode to TEL mode (page 33), TEL/FAX mode (page 33) or TAM/FAX mode (page 34).
[REDIAL] or [PAUSE] on the base unit does not function properly.	<ul style="list-style-type: none"> • If this button is pressed during dialling, a pause will be inserted. If pressed immediately after a dial tone is obtained, the last number dialled will be redialled.
During programming, I cannot enter the code or ID number.	<ul style="list-style-type: none"> • All or part of the number is the same as another code or ID. Change the number: <ul style="list-style-type: none"> – remote operation ID (code): page 40, or feature #11 on page 42. – fax activation code: feature #41 on page 45. – auto disconnection code: feature #49 on page 45.
The ink film runs out quickly.	<ul style="list-style-type: none"> • Even if there are only a few sentences, every page that comes out of the machine is considered a full page. • Turn OFF the following features: <ul style="list-style-type: none"> – sending report: feature #04 on page 42. – journal report: feature #22 on page 43. – Caller ID list: feature #26 on page 44.
The base unit beeps.	<ul style="list-style-type: none"> • The memory reception alert of feature #44 is ON (page 45), and the unit has a document in memory. Press [STOP] to stop the beeps, then see the displayed message instructions to solve the problem.
The speakerphone is not working.	<ul style="list-style-type: none"> • Use the speakerphone in a quiet room. • If you have difficulty hearing the other party, adjust the volume.

Problem	Cause & Solution
I cannot page a cordless handset or base unit.	<ul style="list-style-type: none"> The cordless handset is too far from the base unit.
Caller information is not displayed.	<ul style="list-style-type: none"> You must subscribe to use a Caller ID service. Contact your service provider/telephone company for details. If you use a DSL/ADSL service, we recommend connecting a DSL/ADSL filter between the base unit and the telephone line jack. Contact your DSL/ADSL provider for details. Other telephone equipment may be interfering with this unit. Disconnect the other equipment and try again. Other electrical appliances connected to the same outlet may be interfering with the Caller ID information. Telephone line noise may be affecting the Caller ID information. The caller requested not to send his/her information (page 27). If a call is being transferred to you, the caller information will not be displayed.
The display exits the Caller ID list while viewing caller information.	<ul style="list-style-type: none"> Do not pause for over 1 minute on the cordless handset or 3 minutes on the base unit while viewing.
Time on the unit has shifted.	<ul style="list-style-type: none"> Incorrect time information from incoming Caller ID changes the time. Set the time adjustment to "MANUAL" (OFF) (feature #33 on page 44).

10.3.3 Cordless handset

Problem	Cause & Solution
The cordless handset does not automatically turn ON after installing/replacing batteries.	<ul style="list-style-type: none"> The battery is empty or too weak to turn ON the power. Place the cordless handset on the base unit or charger, and let it charge.
The cordless handset does not work.	<ul style="list-style-type: none"> Make sure that the batteries are installed correctly (page 18) and fully charge them (page 21). Fully charge the batteries (page 21). Check the connections (page 20). Clean the charge contacts and charge again (page 21). Turn the cordless handset power OFF, then ON (page 21). Check that the mains lead is connected properly. The cordless handset has not been registered to the base unit. Register the cordless handset (page 50).
I do not know how to erase → (Missed call) from the display.	<ul style="list-style-type: none"> There are unviewed missed calls remaining. View them and erase → in the following way. <ol style="list-style-type: none">  "Caller List" → OK Press [▼] to search from the most recent call, or press [▲] to search from the oldest call.
The cordless handset display is blank.	<ul style="list-style-type: none"> The cordless handset is not turned ON. Turn the power ON (page 21).
The cordless handset will not turn ON.	<ul style="list-style-type: none"> Make sure that the batteries are installed correctly (page 18). Fully charge the batteries (page 21). Clean the charge contacts and charge again (page 21).
I have changed the cordless handset display language to a language I cannot read.	<ul style="list-style-type: none"> Change the cordless handset display language (page 49).

10. Help

Problem	Cause & Solution
While programming, the cordless handset starts to ring.	<ul style="list-style-type: none">● A call is being received. Answer the call and start again after hanging up.
∇ is flashing.	<ul style="list-style-type: none">● The cordless handset is not registered to the base unit. Register it (page 50).● The cordless handset is too far from the base unit. Move closer.● The mains lead is not connected. Check the connections.● You are using the cordless handset or base unit in an area with high electrical interference. Re-position the base unit and use the cordless handset away from sources of interference.
The cordless handset does not ring.	<ul style="list-style-type: none">● The ringer volume is turned OFF. Adjust it (page 21).
Static, sound cuts in/out, fades. Interference from other electrical units.	<ul style="list-style-type: none">● Place the cordless handset and the base unit away from other electrical appliances.● Move closer to the base unit.
Noise is heard, sound cuts in and out.	<ul style="list-style-type: none">● You are using the cordless handset or base unit in an area with high electrical interference. Re-position the base unit and use the cordless handset away from sources of interference.● Move closer to the base unit.● If you use a DSL/ADSL service, we recommend connecting a DSL/ADSL filter between the base unit and the telephone line jack. Contact your DSL/ADSL provider for details.
The cordless handset beeps and/or  flashes.	<ul style="list-style-type: none">● Battery charge is low. Fully charge the batteries (page 21).
I fully charged the batteries, but  still flashes.	<ul style="list-style-type: none">● Clean the charge contacts and charge again (page 21).● It is time to replace the batteries (page 18).
I fully charged the batteries, but the operating time seems to be shorter.	<ul style="list-style-type: none">● Clean the battery ends (⊕, ⊖) and the charge contacts with a dry cloth and charge again.
I cannot make calls with the cordless handset.	<ul style="list-style-type: none">● The cordless handset is too far from the base unit. Move closer and try again.● Another unit is in use. Wait and try again later.● The key lock feature is turned ON. Turn it OFF (page 24).
The name stored in the phonebook is not fully displayed while an outside call is being received.	<ul style="list-style-type: none">● Edit the phonebook item name to fit in 1 line of text (page 25).
I cannot register a cordless handset to a base unit.	<ul style="list-style-type: none">● The maximum number of cordless handsets are already registered to the base unit. Cancel unused cordless handset registrations from the base unit (page 50).● You entered the wrong PIN. If you forget your PIN, consult your nearest Panasonic service centre.● Place the cordless handset and the base unit away from other electrical appliances.

10.3.4 Fax – sending

Problem	Cause & Solution
I cannot send documents.	<ul style="list-style-type: none"> • The other party's fax machine is busy or has run out of recording paper. Try again. • The other party's machine is not a fax machine. Check with the other party. • The other party's fax machine failed to answer the fax automatically. Send the fax manually (page 30). • The memory is full of received documents and the quick scan (feature #34 on page 44) is ON. Turn this feature OFF, and send the fax again.
I cannot send a fax overseas.	<ul style="list-style-type: none"> • Use the overseas transmission mode (feature #23 on page 43). • Add two pauses at the end of the telephone number or dial manually.
The other party complains that letters on their received document are distorted or not clear.	<ul style="list-style-type: none"> • If your line has special telephone services such as call waiting, the service may have been activated during fax transmission. Connect the unit to a line that does not have these services. • Another telephone on the same line is off the hook. Hang up the telephone and try again. • Try copying the document with this unit. If the copied image is clear, there may be something wrong with the other party's machine. • Adjust the scan contrast using feature #58 (page 45).
The other party complains that black lines, white lines or smudges appear on their received document.	<ul style="list-style-type: none"> • The scanner glass or rollers are dirty with correction fluid, etc. Clean them (page 65). Please do not insert a document before correction fluid has dried completely.
Documents frequently misfeed.	<ul style="list-style-type: none"> • Clean the document feeder rollers, recording paper feeder and rubber flap (page 65).

10.3.5 Fax – receiving



Problem	Cause & Solution
I cannot receive documents.	<ul style="list-style-type: none"> • The ink film is empty. Replace the ink film with a new one (page 15).
I cannot receive documents automatically.	<ul style="list-style-type: none"> • The receiving mode is set to TEL mode. Change the receiving mode: <ul style="list-style-type: none"> – TAM/FAX mode (page 34), FAX ONLY mode (page 35) or TEL/FAX mode (page 33). • The time taken to answer the call is too long. Decrease the number of rings (page 40, feature #06 on page 42, or #78 on page 46). • The greeting message is too long. Record a shorter message (page 38).
The display shows "CONNECTING", but faxes are not received.	<ul style="list-style-type: none"> • The receiving mode is set to FAX ONLY mode and the incoming call is not a fax. Change the receiving mode: <ul style="list-style-type: none"> – TAM/FAX mode (page 34), TEL mode (page 33) or TEL/FAX mode (page 33).
A blank sheet is ejected.	<ul style="list-style-type: none"> • If a blank sheet is ejected after the received document is printed out, the size of the document sent by the other party is as large as, or larger than, the recording paper, and the receiving reduction rate is not programmed correctly. Program the proper rate in feature #36 (page 44). • The other party placed the document in their fax machine facing the wrong way. Check with the other party.

10. Help

Problem	Cause & Solution
The printing quality is poor.	<p>Please do not reuse the ink film! Please use genuine Panasonic replacement film. Refer to page 11 for further details.</p> <ul style="list-style-type: none"> • The thermal head is dirty. Clean it (page 66). • If documents can be copied properly, the unit is working normally. The other party may have sent a faint document or there may be something wrong with the other party's machine. Ask them to send a clearer copy of the document or to check their fax machine. • Some paper has instructions recommending which side to print on. Try turning the recording paper over. • You may have used paper with cotton and/or fibre content that is over 20%, such as letterhead or resume paper.
Recording paper frequently misfeeds.	<ul style="list-style-type: none"> • Clean the document feeder rollers, recording paper feeder and rubber flap (page 65).
Letters on the received document are distorted.	<ul style="list-style-type: none"> • If your line has special telephone services such as call waiting, the service may have been activated during fax reception. Connect the unit to a line that does not have these services.
I cannot receive documents using the cordless handset.	<ul style="list-style-type: none"> • The memory is full of received documents due to a lack of recording paper, a lack of ink film or a recording paper jam. Install paper (page 17), install ink film (page 15) or remove the jammed paper (page 64).
When an extension telephone is connected, I cannot receive documents by pressing [*][#][9].	<ul style="list-style-type: none"> • You must set remote fax activation to ON (feature #41 on page 45) beforehand. • You may have changed the remote fax activation code from [*][#][9] (default setting). Verify the remote fax activation code (feature #41 on page 45). • The memory is full of received documents due to a lack of recording paper, a lack of ink film or a recording paper jam. Install paper (page 17), install ink film (page 15) or remove the jammed paper (page 64).
The other party complains that they cannot send a document.	<ul style="list-style-type: none"> • The receiving mode is set to TEL mode. Receive the document manually (page 33) or change the receiving mode to TAM/FAX mode (page 34), FAX ONLY mode (page 35) or TEL/FAX mode (page 33). • The memory is full of received documents due to a lack of recording paper, a lack of ink film or a recording paper jam. Install paper (page 17), install ink film (page 15) or remove the jammed paper (page 64).
I cannot select the desired receiving mode.	<ul style="list-style-type: none"> • If you want to set TAM/FAX or FAX ONLY mode: <ul style="list-style-type: none"> – select the desired mode using feature #77 (page 46), and press [AUTO ANSWER] repeatedly until the desired mode is displayed. • If you want to set TEL mode or TEL/FAX mode: <ul style="list-style-type: none"> – select the desired mode using feature #73 (page 46), and press [AUTO ANSWER] repeatedly until the desired mode is displayed.

10.3.6 Copying

Problem	Cause & Solution
The unit will not make a copy.	<ul style="list-style-type: none"> • The ink film is empty. Replace the ink film with a new one (page 15). • You cannot make a copy during programming. • You cannot make a copy during a telephone conversation.
A black line, white line or smudge appears on the copied document.	<ul style="list-style-type: none"> • The scanner glass or rollers are dirty with correction fluid, etc. Clean them (page 65). Please do not insert a document before correction fluid has dried completely.
The copied image is distorted.	<ul style="list-style-type: none"> • Adjust the width of the document guides to fit the actual size of the document.

Problem	Cause & Solution
<p>The printing quality is poor.</p> <p>Original</p>  <p>Copy</p> 	<p>Please do not reuse the ink film!</p> <p>Please use genuine Panasonic replacement film. Refer to page 11 for further details.</p> <ul style="list-style-type: none"> • The thermal head is dirty. Clean it (page 66). • Some paper has instructions recommending which side to print on. Try turning the recording paper over. • You may have used paper with a cotton and/or fibre content that is over 20%, such as letterhead or resume paper.
<p>Documents or recording paper frequently misfeed.</p>	<ul style="list-style-type: none"> • Clean the document feeder rollers, recording paper feeder and rubber flap (page 65).

10.3.7 Answering machine

Problem	Cause & Solution
<p>I cannot listen to messages from a remote location.</p>	<ul style="list-style-type: none"> • Activate the remote operation feature by setting the remote operation ID beforehand (page 40, feature #11 on page 42). Press the remote operation ID correctly and firmly. • The unit is not in TAM/FAX mode. Change to TAM/FAX mode (page 34).
<p>The other party complains that they cannot leave a voice message.</p>	<ul style="list-style-type: none"> • The recording time is set to "GREETING ONLY". Select "1 MINUTE" or "3 MINUTES" (page 40, feature #10 on page 42). • The memory is full. Erase unnecessary messages (page 38, 39). • Make sure there is no other answering machine connected on the same line.
<p>I cannot operate the answering machine with the cordless handset.</p>	<ul style="list-style-type: none"> • Someone is operating the answering machine. • You are too far from the base unit. Move closer to the base unit.
<p>The message indicator flashes slowly.</p>	<ul style="list-style-type: none"> • This is normal. New messages have been recorded. Listen to the new messages (page 38, 39).
<p>Caller ID information does not display during message playback.</p>	<ul style="list-style-type: none"> • The caller information will not be displayed if a message is recorded by using [MEMO] (page 39).

10.3.8 If a power failure occurs

- The unit will not function.
- The unit is not designed for making emergency telephone calls when the power fails. Alternative arrangements should be made for access to emergency services.
- Fax transmission and reception will be interrupted.
- If delayed transmission (feature #25 on page 43) is programmed and a power failure prevents the document from being sent at the set time, the document will be sent after power is restored.
- If any fax documents are stored in the memory, they will be lost. When power is restored, a power down report will be printed stating which documents in memory have been erased.

11.1 Recording paper jams

11.1.1 When the recording paper has jammed in the unit

The display will show the following:

- "PAPER JAMMED"

Important:

- Remove the recording paper, then remove the paper tray beforehand, otherwise the paper may misfeed or jam.

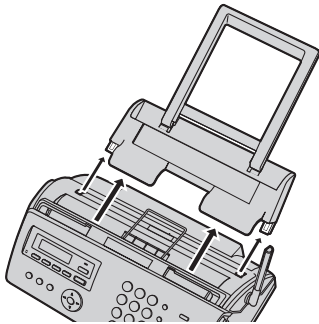

- 1 Open the front cover (①), push the green button (②), then open the back cover (③).

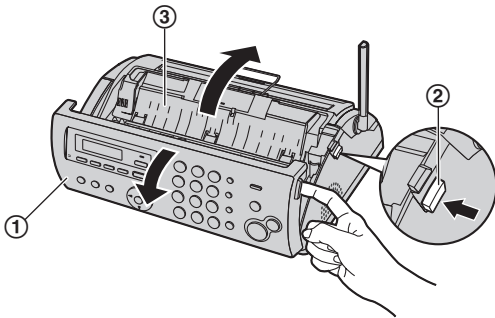

- 2 Remove the jammed recording paper (④).

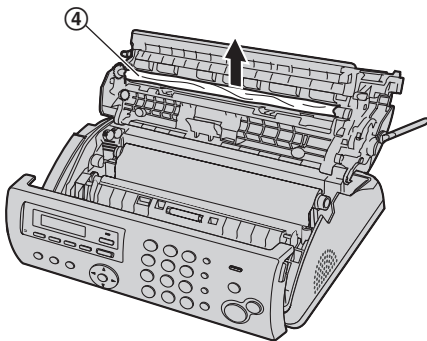

- 3 Turn the blue gear (⑤) in the direction of the arrow until the ink film is tight (⑥) and at least one layer of ink film is wrapped around the blue core (⑦).

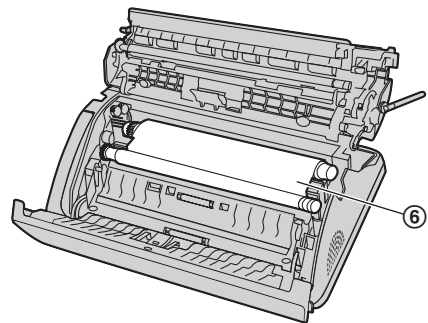
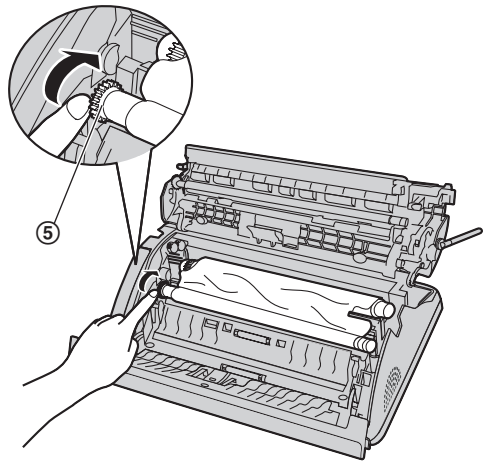

Correct

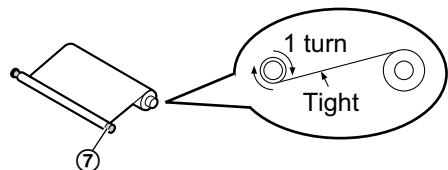

Incorrect

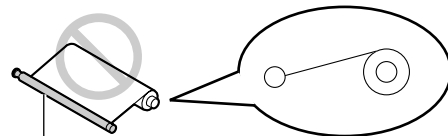

No ink film is wrapped around the blue core.

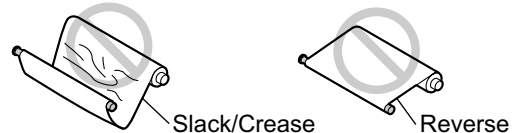

- 4 Close the back cover securely by pushing down on the dotted area at both ends (⑧), then close the front cover securely (⑨).

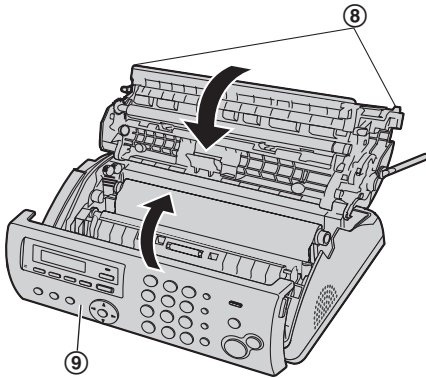

- 5 Install the paper tray (page 17), then insert the recording paper gently (page 17).

11.1.2 When the recording paper was not fed into the unit properly

The display will show the following:

- “CHECK PAPER”

Remove the recording paper and straighten. Insert the paper, then press **[SET]** to clear the message.

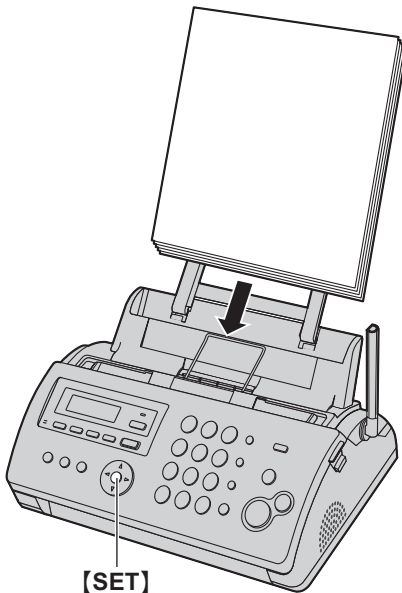

11.2 Document jams

- 1 Open the front cover. Remove the jammed document carefully (①).

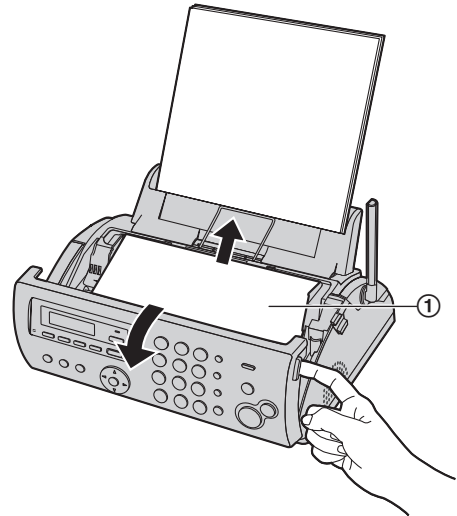

- 2 Close the front cover securely.

Note:

- Do not pull out the jammed paper forcibly before opening the front cover.

11.3 Document feeder/recording paper feeder/scanner glass cleaning

Clean the document feeder/recording paper feeder/scanner glass when:

- Documents or recording paper frequently misfeed.
- Smudges or black/white lines appear on the original document when sending or copying.

Important:

- Remove the recording paper, then remove the paper tray beforehand, otherwise the paper may misfeed or jam.

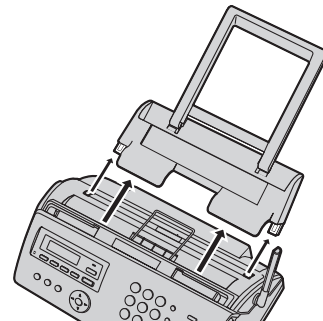

11. Maintenance

- 1 Disconnect the mains lead and the telephone line cord.
- 2 Open the front cover (①), push the green button (②), then open the back cover (③).

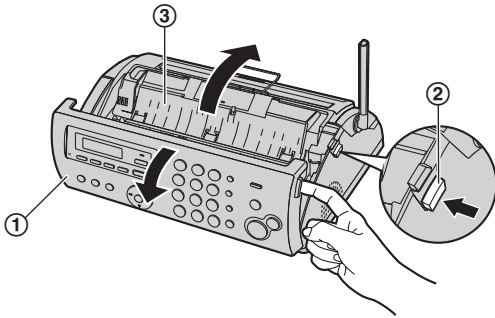

- 4 Clean the recording paper feeder roller (⑦) with a cloth moistened with isopropyl rubbing alcohol, and let all parts dry thoroughly.

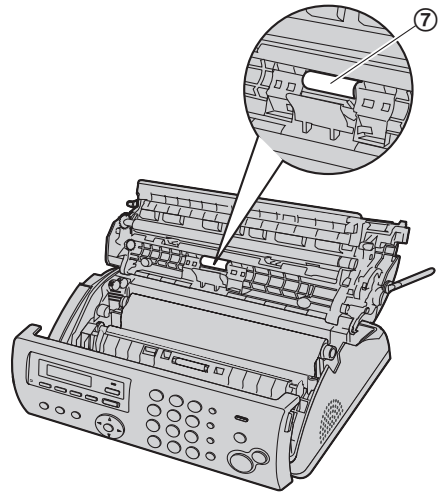

- 3 Clean the document feeder rollers (④) and rubber flap (⑤) with a cloth moistened with isopropyl rubbing alcohol, and let all parts dry thoroughly. Clean the scanner glass (⑥) with a soft, dry cloth.

Caution:

- Do not use paper products, such as paper towels or tissues.

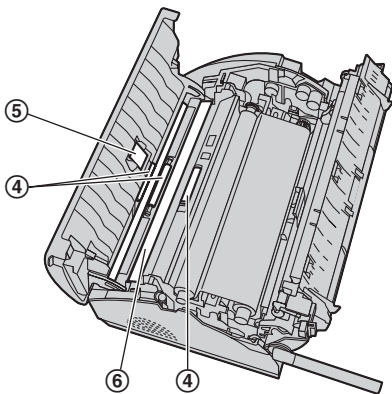

- 5 Close the back cover securely by pushing down on the dotted area at both ends (⑧), then close the front cover securely (⑨).

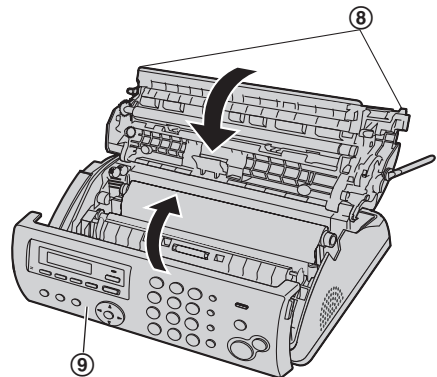

- 6 Install the paper tray (page 17), then insert the recording paper gently (page 17).
- 7 Connect the mains lead and the telephone line cord.

11.4 Thermal head cleaning

If smudges or black/white lines appear on a copied/received document, check whether there is dust on the thermal head. Clean the thermal head to remove the dust.

Important:

- Remove the recording paper, then remove the paper tray beforehand, otherwise the paper may misfeed or jam.

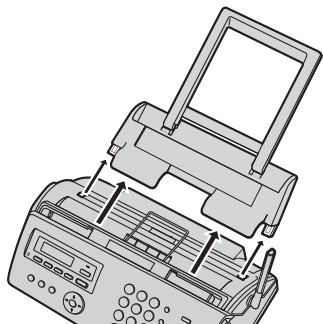

- 1 Disconnect the mains lead and the telephone line cord.
- 2 Open the front cover (1), push the green button (2), then open the back cover (3).

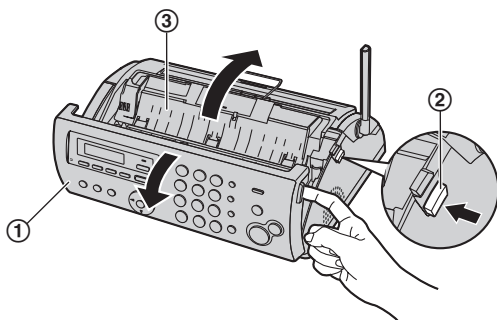

- 3 Remove the ink film (4).

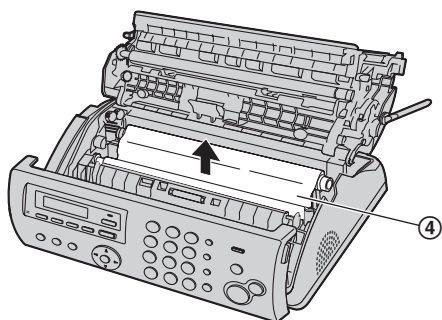

- 4 Clean the thermal head (5) with a cloth moistened with isopropyl rubbing alcohol, and let it dry thoroughly.

Caution:

- To prevent a malfunction due to static electricity, do not use a dry cloth and do not touch the thermal head directly.

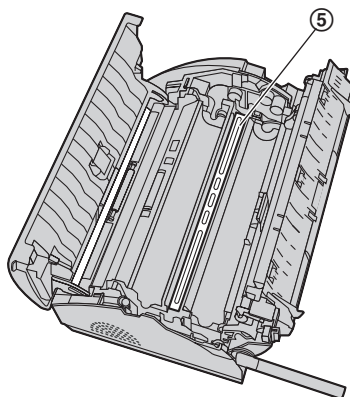

- 5 Re-install the ink film and close the covers (see step 4 to 7 on page 15).
- 6 Install the paper tray (page 17), then insert the recording paper gently (page 17).
- 7 Connect the mains lead and the telephone line cord.

12.1 Reference lists and reports (Base unit only)

You can print out the following lists and reports for your reference:

- "SETUP LIST"
- "PHONEBOOK LIST"
- "JOURNAL REPORT"
- "BROADCAST LIST"
- "PRINTER TEST"
 - If the test print has a smudges, blurred points or lines, clean the thermal head (page 66).
- "CALLER ID LIST"

You can set the following lists and reports to print automatically:

- "AUTO JOURNAL"
 - See feature #22 on page 43 for details.
- "AUTO CALL. LIST"
 - See feature #26 on page 44 for details.

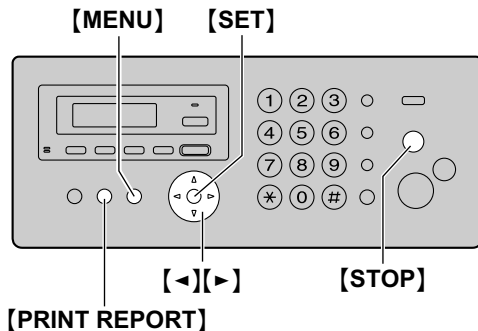

- 1 [PRINT REPORT]
- 2 Press [◀] or [▶] repeatedly to display the desired item.
- 3 [SET]
 - If you select to print out a list or a report, printing will start.
To stop printing, press [STOP].
 - If you select "AUTO JOURNAL" or "AUTO CALL. LIST", press [0] or [1] to select the desired setting, then press [SET].
 - [0] "OFF"
 - [1] "ON"
- 4 [MENU]

12.2 Specifications

12.2.1 Base unit

■ **Applicable lines:**

Public Switched Telephone Network

■ **Document size:**

Max. 216 mm in width, Max. 600 mm in length

■ **Effective scanning width:**

208 mm

■ **Effective printing width:**

202 mm

■ **Transmission time*1:**

Approx. 12 s/page (ECM-MMR)*2

■ **Scanning density:**

Horizontal: 8 pels/mm
Vertical: 3.85 lines/mm – in standard resolution,
7.7 lines/mm – in fine/photo resolution,
15.4 lines/mm – in super fine resolution

■ **Photo resolution:**

64-level

■ **Scanner type:**

Contact Image Sensor

■ **Printer type:**

Thermal Transfer on plain paper

■ **Data compression system:**

Modified Huffman (MH), Modified READ (MR), Modified Modified READ (MMR)

■ **Modem speed:**

9,600 / 7,200 / 4,800 / 2,400 bps; Automatic Fallback

■ **Operating environment:**

5 °C – 35 °C, 20 % – 80 % RH (Relative Humidity)

■ **Dimensions:**

KX-FC265: Approx. height 106 mm × width 374 mm × depth 200 mm

KX-FC275: Approx. height 106 mm × width 367 mm × depth 200 mm

■ **Mass (Weight):**

KX-FC265: Approx. 2.7 kg

KX-FC275: Approx. 2.8 kg

■ **Power consumption:**

Standby:

KX-FC265: Approx. 4.0 W

KX-FC275: Approx. 2.5 W

Transmission: Approx. 15 W

Reception: Approx. 40 W (When receiving a 20 % black document)

Copy: Approx. 40 W (When copying a 20 % black document)

Maximum: Approx. 135 W (When copying a 100 % black document)

■ **Power supply:**

220 V – 240 V AC, 50 Hz

■ **Fax memory capacity*3:**

Approx. 25 pages of memory transmission

Approx. 28 pages of memory reception

(Based on the ITU-T No. 1 Test Chart in standard resolution, without using the Error Correction Mode.)

■ **Voice memory capacity*4:**

Approx. 15 minutes of recording time

■ **Copy memory capacity:**

Approx. 10 pages (Based on the ITU-T No. 1 Test Chart in fine resolution.)

■ **CIS's LED light properties:**

LED radiation output: Max. 1 mW

Wavelength: Yellowish Green 570 nm typical

Emission duration: Continuous

- *1 Transmission speed depends upon the contents of the pages, resolution, telephone line conditions and capability of the other party's machine.
- *2 Transmission speed is based upon the ITU-T No. 1 Test Chart with original mode. If the capability of the other party's machine is inferior to your unit, the transmission time may be longer.
- *3 If an error occurs during fax reception, such as a paper jam or if the recording paper runs out, the fax and subsequent faxes will be retained in memory.
- *4 Recording time may be reduced by the calling party's background noise.

ITU-T No. 1 Test Chart

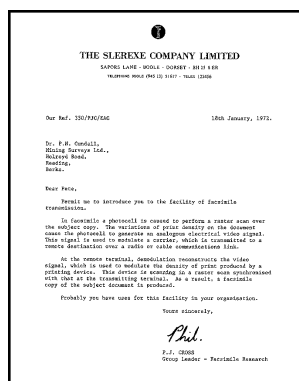

Note:

- Design and specifications are subject to change without notice.
- The pictures and illustrations in these instructions may vary slightly from the actual product.

Recording paper specifications

Recording paper size:

A4: 210 mm × 297 mm

Recording paper weight:

64 g/m² to 80 g/m²

12.2.2 Cordless handset

■ **Standard:**

DECT (Digital Enhanced Cordless Telecommunications)

GAP (Generic Access Profile)

■ **Number of channels:**

120 Duplex Channels

■ **Frequency range:**

1.88 GHz to 1.90 GHz

■ **Duplex procedure:**

TDMA (Time Division Multiple Access)

■ **Channel spacing:**

1,728 kHz

■ **Bit rate:**

1,152 kbit/s

■ **Modulation:**

GFSK (Gaussian Frequency Shift Keying)

■ **RF transmission power:**

Approx. 10 mW (average power per channel)

■ **Voice coding:**

ADPCM 32 kbit/s

■ **Operating environment:**

0 °C – 40 °C, 20 % – 80 % RH (Relative Humidity)

■ **Dimensions:**

Approx. height 158 mm × width 48 mm × depth 30 mm

■ **Mass (Weight):**

Approx. 130 g

12.2.3 Charger unit (KX-FC275 only)

■ **Operating environment:**

0 °C – 40 °C, 20 % – 80 % RH (Relative Humidity)

■ **Dimensions:**

Approx. height 52 mm × width 75 mm × depth 88 mm

■ **Mass (Weight):**

Approx. 60 g

■ **Power consumption:**

Standby: Approx. 0.2 W

Maximum: Approx. 3.2 W

■ **Power supply:**

AC adaptor (220 V – 240 V AC, 50 Hz)

12.3 Condition of guarantee

1. This machine is supplied with a one year swap out warranty. Please retain your Proof of Purchase and Packaging in the unlikely event that your machine should require attention. For further information, please contact following:
 - For UK: 0844 844 3878 (for fax machine) / 0844 844 3867 (for MFP)
 - For the Republic of Ireland: 01 6130082 (for fax machine) / 01 2898255 (for MFP)In addition you can visit our web site at www.panasonic.co.uk
2. This warranty is in addition to and does not in any way affect any statutory or other right of consumer purchasers. This warranty relates only to product used within Mainland Great Britain, please refer to your dealer warranty information relating to use elsewhere within the United Kingdom and Ireland.
3. You should complete the registration form overleaf and fax it to us with 7 days of purchase; failure to do so may result in delays in providing warranty service.
4. This warranty covers breakdowns due to design or manufacturing faults; it does not apply to damage, however caused, wear or tear, neglect, incorrect adjustment or repair, or to any items of limited natural life.
5. This warranty does not cover consumables, i.e. ink films, film refills, ink cartridges, toner cartridges, drum units, paper and paper loads or any optional accessories which may have been purchased either at the same time as, or subsequent to, the main unit. Such accessories should be returned to the point of purchase if found to be faulty.
6. In the event of a failure, please take the following action;
 - a) Refer to the "Help" section of your instruction manual in order to identify and possibly correct the problem:
 - b) If the problem is not resolved after referring to the user guide, please contact our customer helpline:
 - For UK: 0844 844 3878 (for fax machine) / 0844 844 3867 (for MFP)
 - For the Republic of Ireland: 01 6130082 (for fax machine) / 01 2898255 (for MFP)
7. In the event the helpline cannot resolve the problem, a like for like exchange FAX/MFP will be despatched. The helpline operator will give you specific instructions on how the exchange will be executed. Failure to comply with these instructions may result in delay and cost to you.
8. The exchange FAX/MFP will be delivered in a customised case by courier. It is the customer's responsibility to promptly remove the exchange FAX/MFP and insert the faulty FAX/MFP in the case provided for collection, to enable the courier to return it to Panasonic.
9. The exchange FAX/MFP is to be regarded as a like for like exchange under warranty and the balance of the warranty period will transfer to the exchange unit. The purchaser's sole and exclusive remedy under this guarantee against Panasonic is for the repair or replacement of the appliance or any defective parts and no other remedy, including, but not limited to; incidental or consequential damage or loss of whatsoever nature shall be available to the purchaser.
10. Where the original FAX/MFP is found to be faulty as a result of unauthorised repairs or modifications or damage either by accident, misuse or improper installation then Panasonic reserves the right to charge the customer a contribution towards repair costs.
11. If at any time during the guarantee period any parts of the appliance are replaced with parts not supplied or approved by us or of an objective quality, safe and suitable for the appliance, or has been dismantled or repaired by any person not authorised by us, we shall have the right to terminate this guarantee in whole or in part immediately without further notice.
12. This warranty applies to the original purchaser only and is not transferable.
13. The warranty period applicable to this product shall be 12 months from the date of purchase.
14. This product is designed for use only on the United Kingdom and Ireland's Public Switched Telephone Network and should be used only for normal purposes and in accordance with standard operating instructions (applies to models with telephone/fax function only).

Please keep these Operating Instructions with your receipt.

Panasonic Business Systems U.K.

Receipt No. _____	Date of Purchase _____
Model No. KX-FC265E/KX-FC275E	Serial No. _____

13.1 Index

#

#01 Date and time: 22
 #02 Your logo: 22
 #03 Your fax number: 23
 #04 Sending report: 30
 #06 FAX ring count: 42
 #06 TAM ring count: 35
 #10 Caller's recording time: 42
 #11 Remote operation ID: 42
 #17 External ringtone: 43
 #22 Automatic journal report: 30
 #23 Overseas mode: 43
 #25 Delayed send: 43
 #26 Automatic Caller ID list: 44
 #33 Time adjustment: 44
 #34 Quick scan: 30, 37
 #36 Receiving reduction: 44
 #39 LCD display contrast: 44
 #41 Fax activation code: 45
 #44 Memory reception alert: 45
 #46 Friendly reception: 45
 #49 Auto disconnection: 45
 #54 Greeting time: 45
 #58 Scan contrast: 45
 #59 Copy phonebook: 52
 #67 Call screening: 45
 #68 ECM selection: 46
 #72 Recall/flash time: 46
 #73 Manual answer: 46
 #76 Connecting tone: 46
 #77 Auto answer: 46
 #78 TEL/FAX ring count: 46
 #80 Set default: 46

A

Accessories: 11
 Paper tray: 17
 Additional cordless handsets: 50
 Advanced features: 43
 Alarm: 49
 Auto answer setting: 46
 Auto disconnection: 45
 Auto talk feature: 25

B

Base unit phonebook
 Copying: 52
 Editing: 26
 Erasing: 26
 Making a phone call: 26
 Sending faxes: 31
 Storing: 26
 Basic features: 42
 Battery
 Charge: 21
 Installation: 18
 Performance: 21

Replacement: 18
 BROADCAST LIST: 68
 Broadcast transmission: 31
 Button description
 Base unit: 12
 Cordless handset: 13

C

Call screening: 45
 Call waiting: 27
 Caller ID: 27
 Calling back: 27
 Storing: 29
 CALLER ID LIST: 27, 44, 68
 Caller's recording time: 42
 Chain dial: 25
 Character entry: 53
 Cleaning: 65
 Conference calls: 51
 Connecting tone: 46
 Connections: 20
 Copy: 37
 Collation: 37
 Enlarge/Reduce: 37
 Cordless handset
 Cancelling: 50
 Locator: 51
 Power ON/OFF: 21
 Registration: 50
 Cordless handset phonebook
 Copying: 52
 Editing: 25
 Erasing: 25
 Making a phone call: 25
 Storing: 25

D

Date and time: 22
 Delayed send: 43
 Display (Base unit)
 Contrast: 44
 Messages: 55
 Display (Cordless handset)
 Contrast: 47
 Icons: 13
 Language: 49
 Messages: 57
 Document size: 30

E

ECM selection: 46
 Extension telephone: 33

F

Fax activation code: 45
 Fax number: 23
 FAX ONLY mode: 32, 35
 Flash time: 46
 Friendly reception: 45

G

Greeting message
TAM/FAX: 38
Greeting message time
TAM/FAX: 45

I

Ink film: 15
Intercom: 50

J

Jams
Document: 65
Recording paper: 64
JOURNAL REPORT: 30, 68
Junk fax prohibitor: 35

K

Key lock: 24
Keytones: 47

L

Listening to recorded messages: 38, 39, 40
Logo: 22

M

Manual answer setting: 46
Memo message: 39
Memory reception alert: 45
Memory redial: 24
Missed call: 27

O

One touch
Base unit: 26
Overseas mode: 43

P

Phonebook
Base unit: 26
Cordless handset: 25
Sending faxes: 31
PHONEBOOK LIST: 68
PIN
Base unit: 47
Polling: 35
Power failure: 63
Power ON/OFF (Cordless handset): 21
PRINTER TEST: 68
Programming
Base unit programming: 42
Cordless handset programming: 47

Q

Quick scan: 30, 37

R

Recall time: 46
Receiving alert: 45
Receiving faxes
Automatically: 34
Manually: 33
Receiving reduction: 44
Recording
Greeting message: 38, 39
Memo message: 39
Recording paper: 17, 69
Recording time
Incoming message: 40, 42
TAM/FAX greeting: 45
Redial list: 24
Redialling
Base unit: 24, 30, 31
Registration: 50
Remote operation: 40
Remote operation ID: 40, 42
Repeater: 50
Reports
Broadcast programming: 68
Broadcast sending: 31
Caller ID: 68
Journal: 30, 55, 68
Phonebook: 68
Power down: 63
Printer test: 68
Sending: 30, 55
Setup: 68
Reset (Base unit): 46
Resolution: 30, 37
Ring count
FAX ONLY: 42
TAM/FAX: 40, 42
TEL/FAX: 46
Ringtone
Base unit: 43
Cordless handset: 47

S

Scan contrast: 45
Sending faxes
Base unit one touch dial: 31
Base unit phonebook: 31
Broadcast: 31
From memory: 30
Manually: 30
Sending report: 30
SETUP LIST: 68
Soft keys: 13
Storing
Broadcast: 31
One touch: 26
Phonebook: 25, 26

T

TAM/FAX mode: 32, 34

TEL mode: 32, 33

TEL/FAX mode: 32, 33

Time adjustment: 44

Transferring a call: 51

V

Voice time/day stamp: 38

Volume

Base unit: 22

Cordless handset: 21



CE 0682

Sales Department:

Panasonic Business Systems U.K.
Panasonic House, Willoughby Road, Bracknell, Berkshire, RG12 8FP

Manufacturer:

Panasonic System Networks Co., Ltd.
1-62, 4-chome, Minoshima, Hakata-ku, Fukuoka 812-8531, Japan

Global web site:

<http://www.panasonic.net/>

Copyright:

- This material is copyrighted by Panasonic System Networks Co., Ltd., and may be reproduced for internal use only. All other reproduction, in whole or in part, is prohibited without the written consent of Panasonic System Networks Co., Ltd.

© Panasonic System Networks Co., Ltd. 2010



FC265E

PNQX3064ZA CM0810DY0